

Leica

BIO SYSTEMS

Aperio GT 450 DX

Quick Reference Guide

MAN-0477, Revision A | April 2022



Aperio GT 450 DX Quick Reference Guide

This manual applies to the Aperio GT 450 DX Controller, Aperio GT 450 DX Console, and Aperio GT 450 DX SAM DX versions 1.1 and later.

Copyright Notice

- ▶ Copyright © 2022 Leica Biosystems Imaging, Inc. All Rights Reserved. LEICA and the Leica logo are registered trademarks of Leica Microsystems IR GmbH. Aperio, GT, and GT 450 are trademarks of Leica Biosystems Imaging, Inc. in the USA and optionally in other countries. Other logos, products, and/or company names might be trademarks of their respective owners..

Contact Information – Leica Biosystems Imaging, Inc.

Headquarters	Customer Support	General Information
 Leica Biosystems Imaging, Inc. 1360 Park Center Drive Vista, CA 92081 USA Tel: +1 (866) 478-4111 (toll free) Direct International Tel: +1 (760) 539-1100	Contact your local support representative with any query and service request. https://www.leicabiosystems.com/service-support/technical-support/	US/Canada Tel: +1 (866) 478-4111 (toll free) Direct International Tel: +1 (760) 539-1100 Email: ePathology@LeicaBiosystems.com

European Union Authorized Representative	UK Responsible Person	Importer	
 CEpartner4U Esdoornlaan 13 3951 DB Maarn The Netherlands	Leica Microsystems (UK) Limited Larch House, Woodlands Business Park Milton Keynes, England, United Kingdom, MK14 6FG	 Leica Biosystems Deutschland GmbH Heidelberger Straße 17-19 69226 Nussloch, Germany	Leica Microsystems (UK) Limited Larch House, Woodlands Business Park Milton Keynes, England, United Kingdom, MK14 6FG

 00815477020297, 00815477020389

 23GT450DXIVD, 23SAMSXIVD



■ Contents

1. INTRODUCTION	5	Load Racks in the Carousel.....	14
Help Videos.....	5	Unload Racks from the Carousel	15
User Guides.....	5	Priority Scanning.....	16
Scanner Overview.....	6	Scan Status.....	17
Touchscreen Interface Overview	7	Scan Statistics.....	18
Scanning Workflow.....	8	Rack View	19
Carousel Rotation	9	Slide View.....	20
Key Concepts	10	Rack Order.....	20
Icon Glossary.....	11	Rack Warnings.....	21
2. SLIDE PREPARATION CHECKLISTS	12	Scan Entire Slide for Whole Rack.....	22
Slides	12	4. MAINTENANCE.....	23
Coverslips.....	12	Maintenance Checklists	23
Slide Labels.....	12	Daily (recommended)	23
Barcodes	12	Six Month.....	23
3. SCAN SLIDES	13	Yearly	23
Load Slides in the Rack.....	13	Restart the Scanner	24

Shut Down the Scanner	24
5. TROUBLESHOOTING	25
Additional Resources	25
Serial Number and Firmware Version	25
Open and Close the Scanner Cover	26
Return Pusher to Safe Position	27
Safe Restart After an Error	28
Errors and Solutions	29
Broken Slides Inside the Scanner	42
6. INDEX	43

Introduction

This guide provides basic steps for using the Aperio GT 450 DX digital slide scanner. See below for additional resources. Please watch the videos (accessible from the touchscreen interface) before working with the scanner.

Help Videos

Access training videos and this guide from the touchscreen:



User Guides

In addition to this guide, the following guides are available:

- ▶ User's Guide
- ▶ IT Manager and Lab Administrator Guide
- ▶ Specifications

Scanner Overview

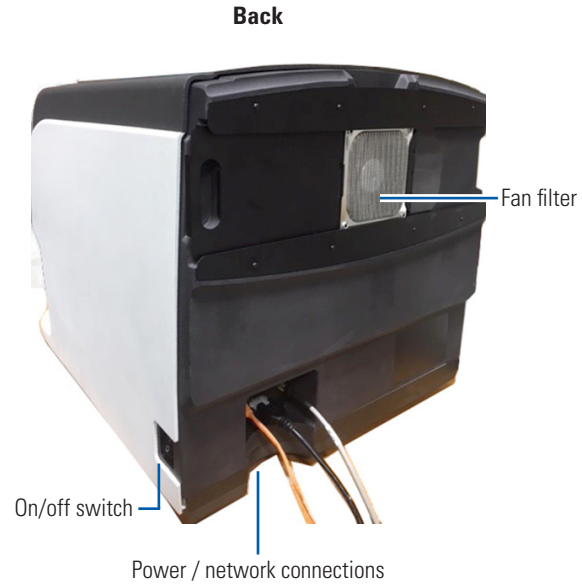
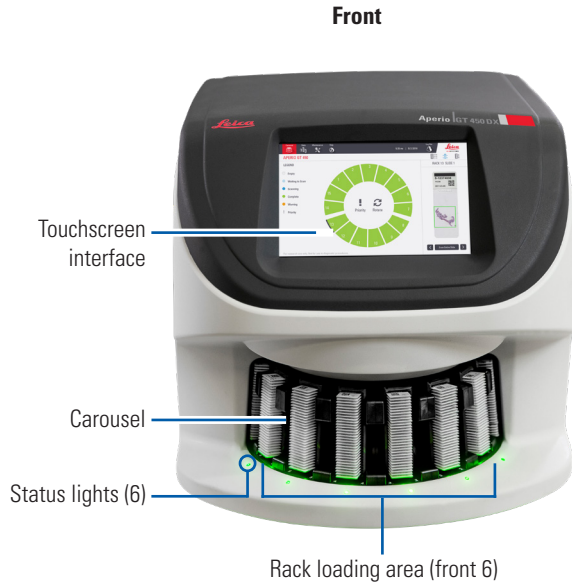

Touchscreen Interface Overview

The example below shows the Home screen.

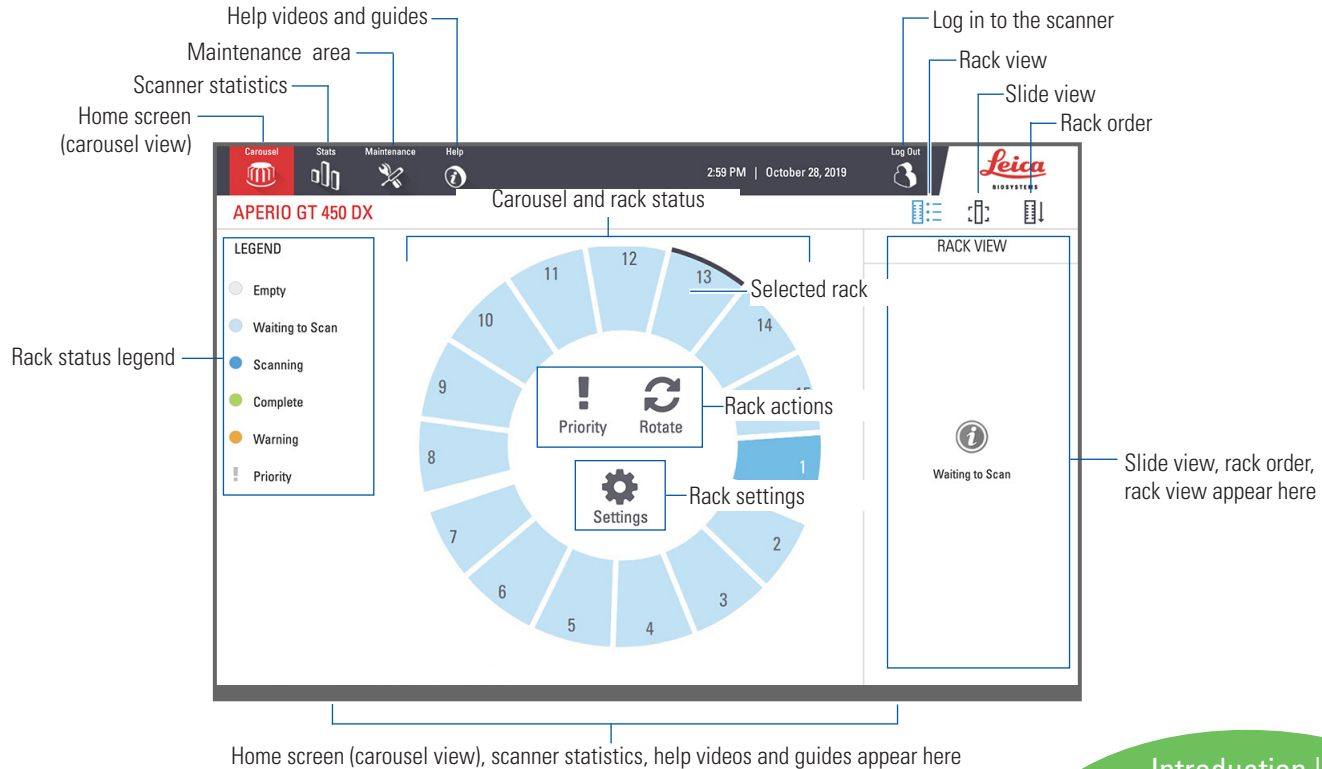

Scanning Workflow

This workflow shows the scanning process for one rack of slides. For step-by-step instructions, go to *"Scan Slides"* on page 13.

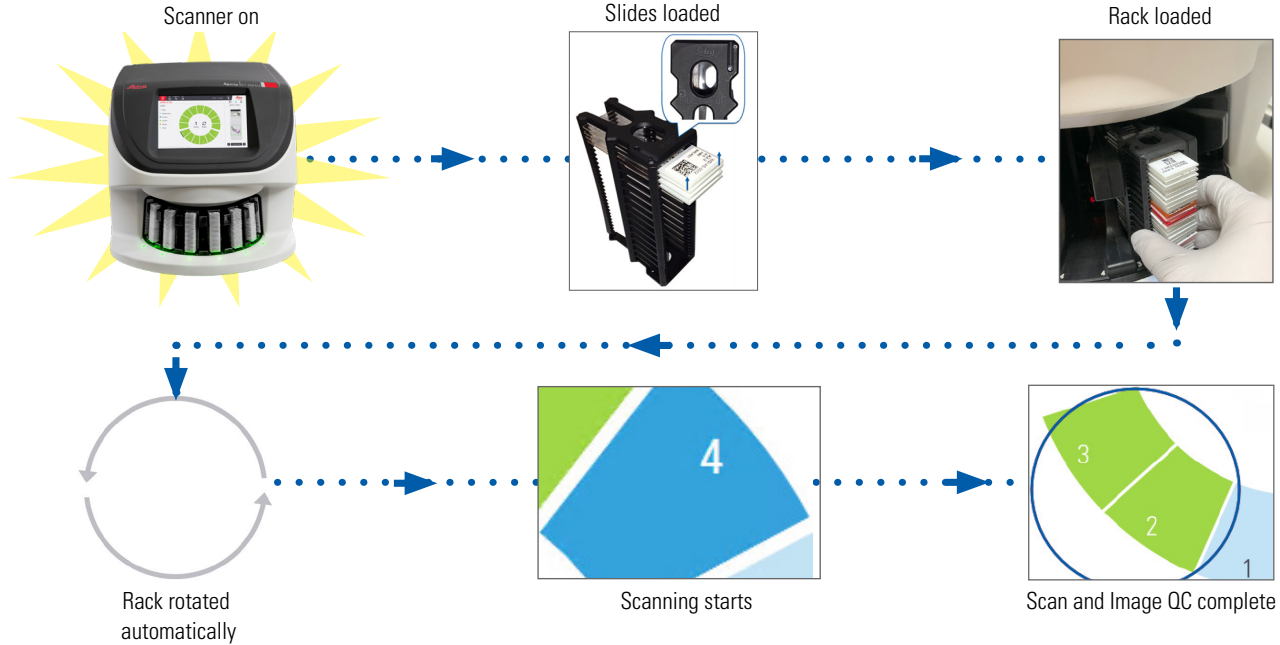

Carousel Rotation

The carousel automatically rotates after you load racks:

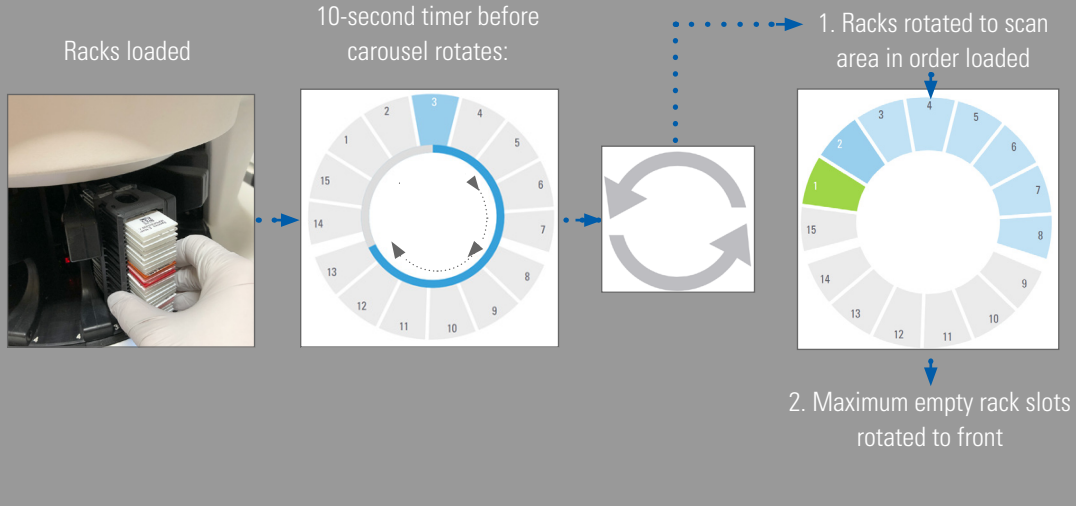

WARNING: Keep hands away from the carousel and pinch point areas when the carousel is rotating.

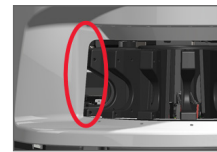

Safety light curtain

An invisible safety light curtain detects objects in the loading area:

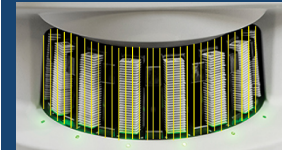

If an object breaks the light curtain:

- the carousel does not rotate
- the 10-second timer starts again

Key Concepts

Scanner settings	Your lab administrator defines the scan settings and sets the PIN codes.
Scan magnification	The Aperio GT 450 DX always scans at 40x.
Rack scanning	All actions, such as setting priority, are applied to an entire slide rack (not individual slides).
Image quality	The Auto-Image QC feature automatically checks image quality as each slide is scanned. If the rack status is green, the scan and Image QC were successful for all slides in the rack.
Slide calibration	Each slide is calibrated when it's scanned.
Continuous loading	The Aperio GT 450 DX is a continuous loading scanner. You can continue to load new racks and unload completed racks without interruption.
Automatic carousel rotation	The carousel rotates the racks automatically. For details, see <i>"Carousel Rotation" on page 9</i> .
Visual status indicators	The carousel view on the touchscreen and the status lights in front of the rack slots provide real-time status.
PIN code / scanner login	If the scanner asks for a PIN code, enter the 5-digit code provided by your Lab Administrator.

Icon Glossary

The following icons appear on the touchscreen interface.



Carousel – Carousel view (Home screen).



Stats – Scanner statistics. (See page 18.)



Help – Instructional videos and user guides.



Login – Scanner login, where you enter your 5-digit PIN code.



Logout – Lock the touchscreen interface.



Slide View – Macro image for the scanned slide.
(See page 20.)



Rack Order – Scan order for racks. (See page 20.)



Rack View – Scan status for each slide in the selected rack. (See page 19.)



Scan completed – In Rack View, indicates the slide scanned successfully, passed image QC, and that the image was saved to the specified image location. (See page 19.)



Slide warning – In Rack View, alerts you of a slide issue. (See page 21.)



Priority scan – On the rack position in the carousel view and in Rack View, indicates the rack's priority scan order, from 1 to 3. (See page 16.)



Rotate – Appears on the touchscreen interface when the carousel is rotating.



Rack Settings – In Carousel view, appears in the center. It also appears on the rack position when rack setting is applied. (See page 22.)

Slide Preparation Checklists

Slides

- Slides stained according to manufacturer's instructions.
- Slides are clean. Wipe with clean lint-free cloth (no chemical cleaners).
- No dirt, fingerprints, markings, writing, extra mounting media, broken slides, chips, or scratches.
- Slides are fully cured (not "wet").
- No mounting media around slide edges.
- No tissue on coverslip edges or overlapping the label.
- No stain residue around slide edge.

Coverslips

- Fully cured coverslip is in place. You must use coverslips with Aperio GT 450 DX.
- Minimal mounting media used.
- No air pockets under coverslip.
- Coverslip is not hanging over the side of the slide.
- Only one coverslip per slide.

Slide Labels

- Only one label per slide.
- Labels do not extend past edges of the slide.
- Labels do not cover any tissue.
- Labels are not under the coverslip.
- Labels are firmly attached.
- Labels are not applied to the bottom surface of the slide.

Barcodes

- Barcode labels meet the same application requirements as slide labels.
- Barcode labels applied to the slide label region.
- Only one barcode label per slide.
- Use only supported barcode labels.
- Use only high-quality printed barcode labels.

Scan Slides

This section contains instructions for scanning slides.

Load Slides in the Rack

1. Make sure the Leica logo and "SIDE UP" text on the rack is facing up.



2. Make sure the slide labels are facing out and up.

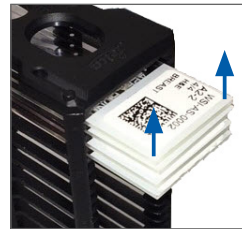

3. Push the slides into the rack until they touch the back of the rack.



Load Racks in the Carousel

Slides are scanned in the order loaded.

1. Place the loaded rack into an open slot in the carousel in the orientation shown on page 13.
2. Push the rack forward until it stops.

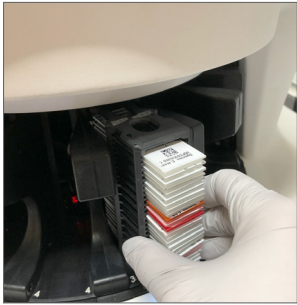

When the rack is fully inserted, there is a “click” sound, and the rack position on the Home screen turns light blue.

3. Continue loading racks as needed or until you fill the front-six rack slots.
4. Wait for the carousel to rotate more empty rack slots to the loading area.

5. Continue loading racks as needed.
6. When a rack is scanned successfully, the rack status turns green.

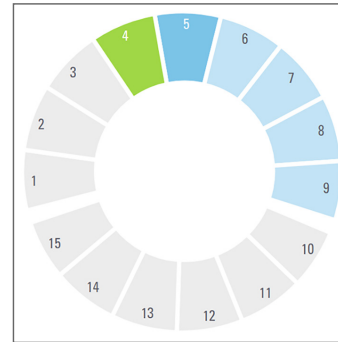

7. You can now remove the completed rack and load another rack.

Unload Racks from the Carousel

1. Remove the rack from the rack slot.

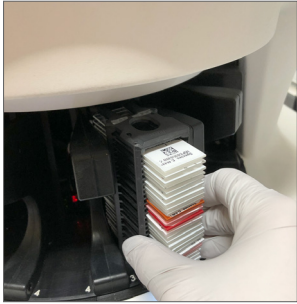

To unload a rack that is not in the loading area:

1. Tap the rack position.

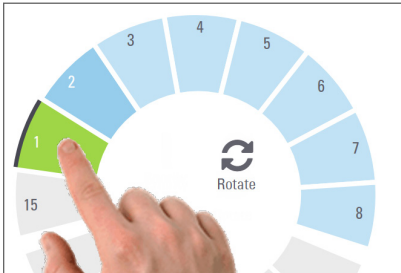

2. Tap **Rotate** to rotate the rack to the loading area.

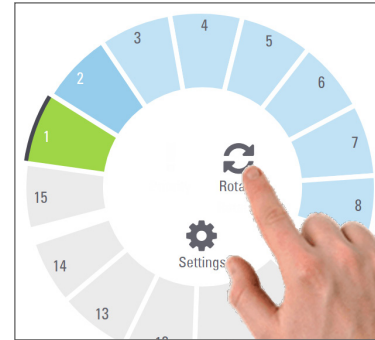

3. After the rack is rotated to the front, carefully remove the rack.

Priority Scanning

Use Priority to move one or more racks to the front of the scan queue. You can apply the Priority option on up to three racks at a time.

1. Tap the rack position.

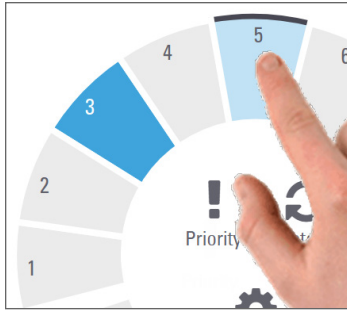

2. Tap **Priority**.

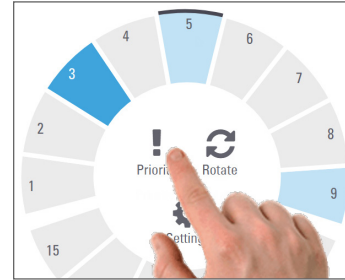

The Priority icon and scan queue number appear:



3. To view the rack scan order, see page 19.

i To cancel a priority, you have to remove the rack.

Scan Status



CAUTION: If you must remove a rack before all slides in the rack are scanned, note the rack and slide status. After removal, the rack's scan status is no longer available.

To check the scan status of a rack:

1. Check the rack position status color against the Legend:

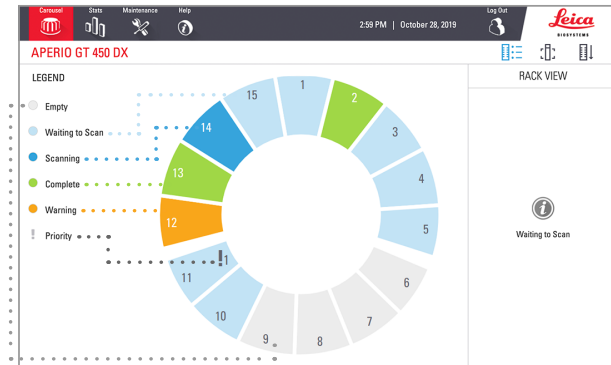

2. The rack statuses are:

Empty	Rack is empty and available for use.
Complete	All slides in the rack scanned successfully and passed image QC. Scanned images are saved to the specific location.
Scanning	The rack is currently being scanned.
Waiting to Scan	The rack is loaded successfully and waiting to scan.
Warning	There is an issue with one or more slides in the rack. See page 21.
Priority	The rack is set for priority scanning (see page 16).

Rack Error on Current Scan

If there is an error on at least one slide in the rack that is currently scanning, the rack position pulses blue and orange. See page 21.

Scan Statistics

To view scan statistics, tap **Stats**. To change the time frame of the statistics, tap the buttons above the graph.

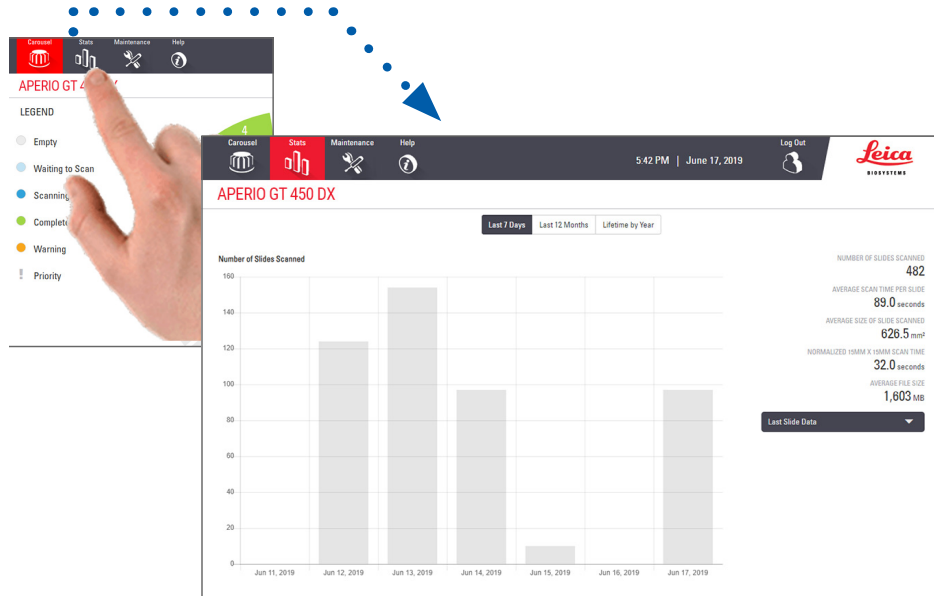

Rack View

1. Tap the **Rack View** icon to show the scan status for each slide in the rack.

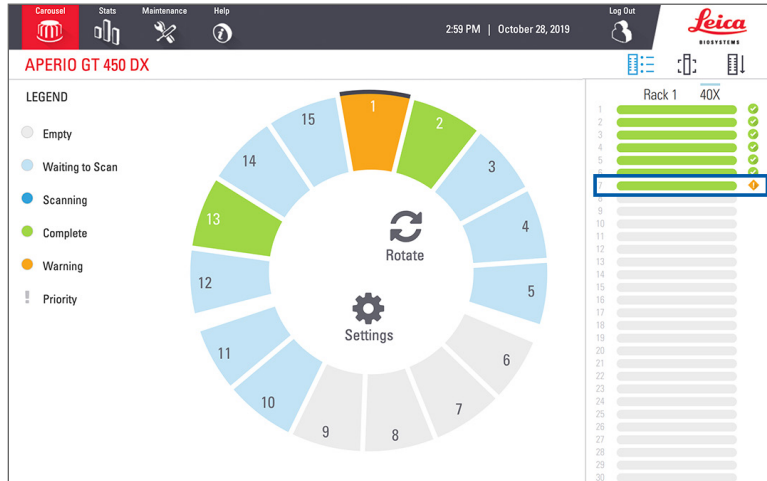

Slide status colors correspond to the Legend:

	The slide is scanning
	The slide is waiting to scan
	The slide slot is empty.
	The scanned image was successfully transferred to the specific image location.
	No scanned image was created. (See page 21.)
	The slide scanned successfully, passed image QC, and was transferred to the specified image location.
	The slide has a warning. (See page 21.)

Slide View

1. Select the rack by tapping it on the touchscreen.
2. Tap the **Slide View** icon to individual images for the selected rack.



- Tap **<** and **>** to view other slides in the rack.
- If any tissue is outside the scan area (the green box), you can tap **Scan Entire Slide** to rescan the whole slide.
- If there is an error scanning the slide, a message appears in the box. (See page 21.)

Rack Order

1. Tap the **Rack Order** icon to show the scan order of the racks.

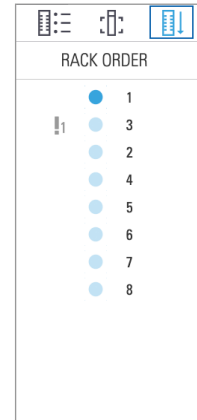

- Racks in the list appear in the scan order.
- The scan status is indicated for each rack.
- In the example, rack 3 is set as priority.

Rack Warnings

An orange rack position indicates a problem with the rack, or one or more slides in the rack.

1. Tap to select the rack position with the warning.
2. Note the error message and number, and go to *“Errors and Solutions”* on page 29.

Rack issues:

Error message and number appears.

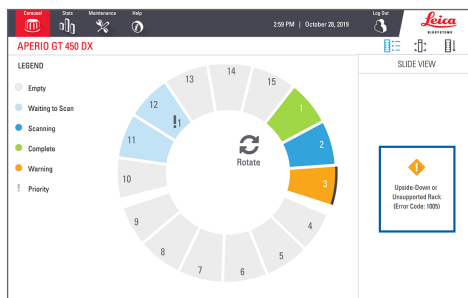

Slide issues:

Orange warning symbol  in Rack View indicates slide error.

Slide error message and number appear in Slide View.

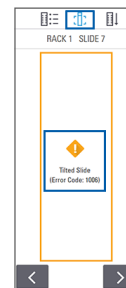
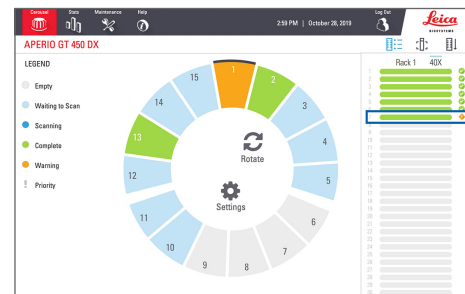

Scan Entire Slide for Whole Rack

This feature enables you to scan the full slide area for a rack of slides.

1. Load only the slides that require a full slide area scan in the rack.
2. Load the rack in the carousel.
3. Tap to select the rack position.
4. Tap **Settings** , and then tap **Scan Entire Slide**.

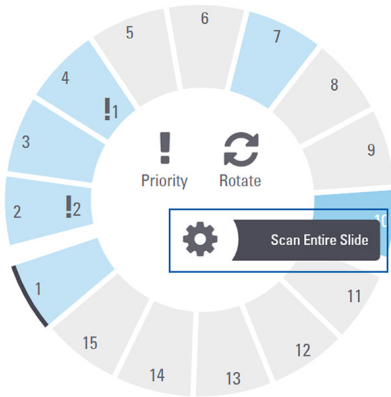

5. The Scan Entire Slide option is selected, and the Settings icon  appears on the rack position.

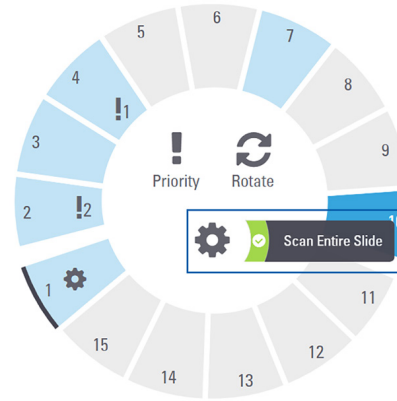

Maintenance

Maintenance Checklists

To maximize scanner performance and image quality, follow this recommended maintenance schedule.

Daily (recommended)

- Restart the scanner. (See page 24.)

Six Month

- Clean the objective and Koehler
- Clean the stage slide tray
- Clean the carousel
- Clean the slide racks
- Clean the fan filter
- Clean the touchscreen
- Clean the scanner cover

The Six Month Maintenance procedures are provided in the "Maintenance" chapter of your scanner user's guide.

Yearly

- Leica Biosystems Technical Services annual maintenance visit. (Contact Leica Biosystems to schedule. See page 2 for contact details.)

Restart the Scanner

Restart the scanner once daily for maintenance.



CAUTION: Restarting the scanner with a slide on the stage may damage the slide.

1. Ensure all racks are unloaded, no slides are scanning, and there are no errors displayed.
2. Tap **Maintenance**, then tap **Restart Scanner**.

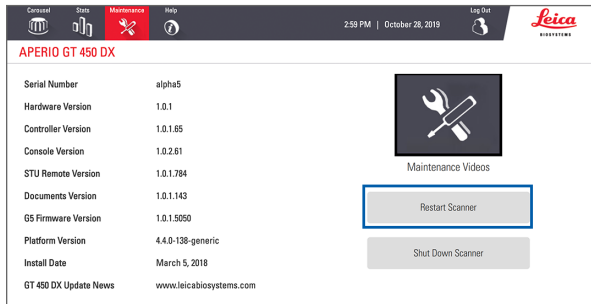

You can use the scanner again after initialization is complete and the Home screen appears.

Shut Down the Scanner

Use this procedure to safely turn off the scanner.

1. From the touchscreen interface, tap **Maintenance**.

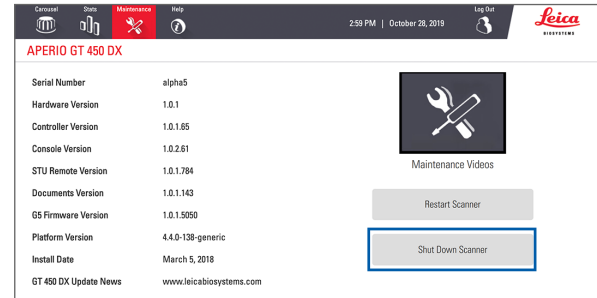

2. Tap **Shut Down Scanner**.
3. After the touchscreen goes dark, turn the scanner off using the On/Off switch.

Troubleshooting

This section provides some common troubleshooting issues and solutions. For a comprehensive list of troubleshooting issues, see the scanner user's guide.

Additional Resources

- ▶ **User's Guide for your GT 450 DX scanner** contains a comprehensive "Troubleshooting" chapter.
- ▶ The Maintenance Videos available from the touchscreen interface include common troubleshooting procedures. Tap **Maintenance**, then tap **Maintenance Videos**.

Serial Number and Firmware Version

You need the serial number and current software version if you call Leica Biosystems Technical Support.

- ▶ Tap **Maintenance** on the touchscreen to view the serial number, firmware version, and other system information.
- ▶ The serial number and firmware version are also available from the Scanner Administration Manager DX (SAM) Client Application Software. See the IT Manager and Lab Administrator Guide for your scanner.

Open and Close the Scanner Cover

You need to open the cover to perform certain maintenance and troubleshooting tasks. For detailed instructions on how to open and close the scanner, see the user's guide for the scanner.

Open the Cover

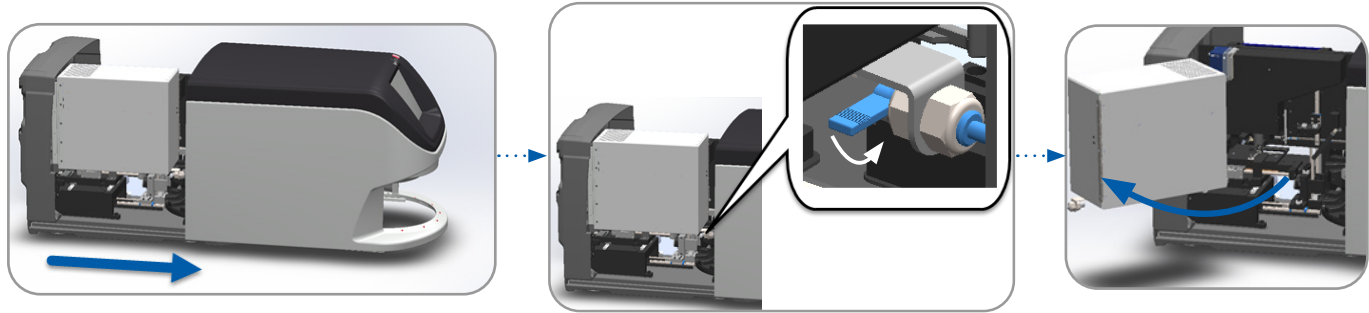

Close the Cover

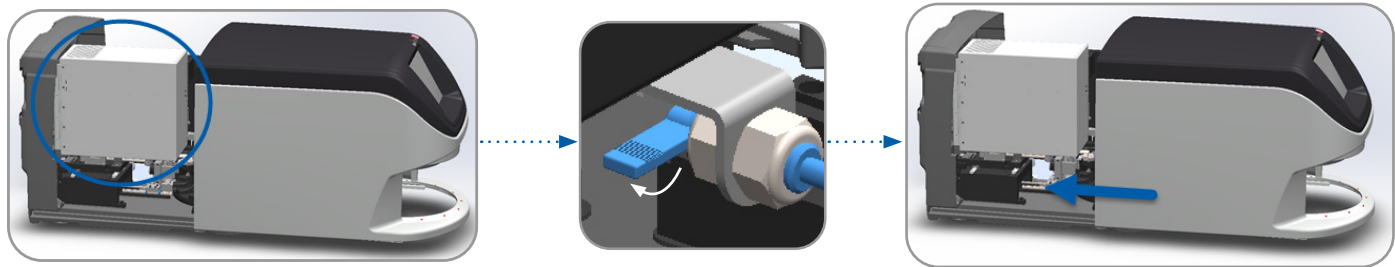

Return Pusher to Safe Position

Follow these steps when the troubleshooting procedure asks you to return the pusher to the safe position.

1. Align the pusher teeth with the slide stage grooves:

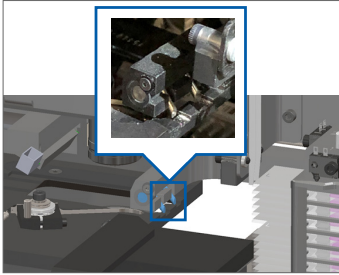

2. Slide the stage to the rear of the scanner:

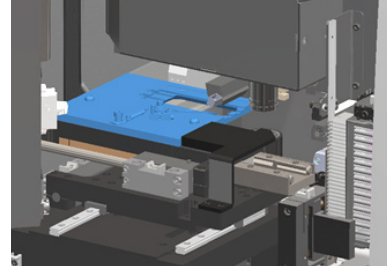

3. Hold the pusher in one of the areas circled in blue, avoiding the LED and objective.

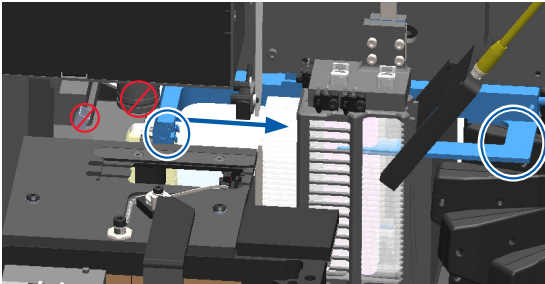

4. Slide the pusher to the front of the scanner as shown.

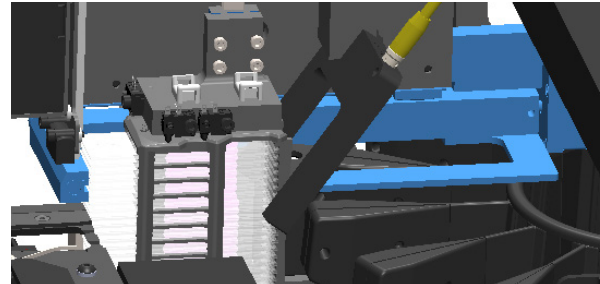

Safe Restart After an Error

Some procedures ask you to restart the scanner. Restarting the scanner initializes the controller and puts the stage and autoloader in their home positions. Before restarting the scanner, you need to ensure there is no slide on the stage.

1. Open the cover and access the interior (see page 26).
2. Check if there is a slide on the stage or partially on the stage.
3. Carefully remove the slide from the stage without touching the surrounding components.

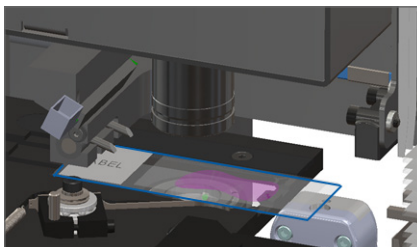

CAUTION: Restarting the scanner with a slide on the stage may damage the slide.

4. Return the pusher to the retracted (safe) position, as shown in “Return Pusher to Safe Position” on page 27.
5. Close the VPU and scanner cover (see page 26).
6. Tap **Maintenance** on the touchscreen interface, then tap **Restart Scanner**.

Errors and Solutions



CAUTION: If you need to remove a rack before all slides in the rack are scanned, first take note of the rack and slide status. After removal, the rack's scan status is no longer available. If an error message is covering the rack and slide status, minimize the error message by tapping the  in the upper-right corner of the message box.

Error Code 1000

Internal Error

1. Open the cover and access the interior (see page 26).
2. Take photos of any obstructions for Leica Biosystems Technical Services.
3. Check if there is a slide on the stage or partially on the stage.
4. Carefully remove the slide from the stage without touching the surrounding components.

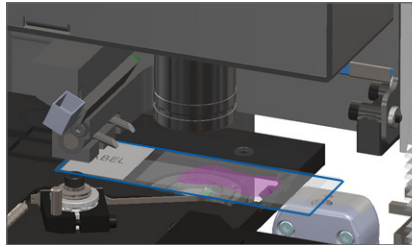

CAUTION: Restarting the scanner with a slide on the stage may damage the slide.

5. If the pusher is extended, return the pusher to the safe position as described in *"Return Pusher to Safe Position"* on page 27.
6. Close the VPU and scanner cover (see page 26).
7. Tap **Restart Scanner**, and wait for the scanner to complete the restart process.

Error Code 1001

Scanner Cannot Initialize

1. Open the cover and access the interior (see page 26).
2. Check if there is a slide on the stage or partially on the stage.
3. Carefully remove the slide from the stage without touching the surrounding components.

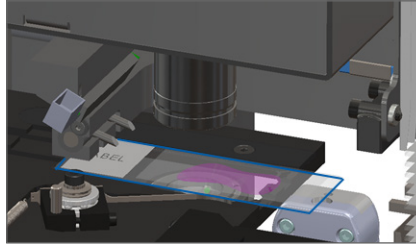

CAUTION: Restarting the scanner with a slide on the stage may damage the slide.

4. If the pusher is extended, return the pusher to the safe position as described in *“Return Pusher to Safe Position”* on page 27.
5. Close the VPU and scanner cover (see page 26).
6. Shut down the scanner using the steps in, page 24.
7. Turn on the scanner, and wait for the initialization process to complete.

Error Code 1002

Carousel cannot rotate.

1. Check the rack loading area and pinch points for any unexpected object:

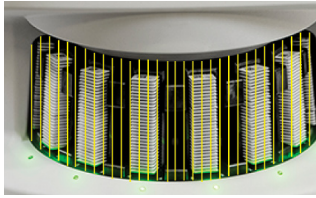

2. Ensure Leica logo faces up and out of the racks, and that racks are inserted fully in the carousel.
3. Ensure all slides are fully inserted into the racks.
4. Check for other obstructions in the rack loading area.
5. If there are no obstructions and carousel still does not rotate, follow the steps in, *"Safe Restart After an Error"* on page 28.

Error Code 1003

Carousel cannot rotate. Carousel pinch point obstructed.

1. Check the rack loading area and pinch points for any unexpected object:

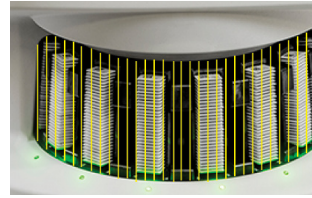

2. If there are no obstructions and carousel still does not rotate, follow the steps in, *"Safe Restart After an Error"* on page 28.

Error Code 1005

Cannot process rack

1. Ensure the rack is inserted correctly. (See page 14.)
2. Remove the rack and check:
 - You are using a supported rack.
 - The rack is not damaged.
3. Verify the error only occurs on one rack. If the error occurs on multiple racks, contact Leica Biosystems Technical Services.
4. If the rack is supported and undamaged, reinsert it into the carousel for scanning.
5. If the scanner still cannot process the rack, contact Leica Biosystems Technical Services.

Error Code 1006

Cannot process one or more slides in rack

1. Tap the rack that has the error, and tap **Rack View** to identify which slides have the error.
2. Tap **Slide View** to view the macro image of the slide, and check the following:
3. Go to “*Slide Error Messages for Error Code 1006*” on page 33 and follow the steps for the specific slide error.

Slide Error Messages for Error Code 1006

After identifying which slide has the error, follow the appropriate steps below.



*You can temporarily hide some error messages by tapping the **x** in the top-right corner.*

Error Message	What to do
Tilted Slide	<ol style="list-style-type: none"> 1. Remove the rack from the carousel. 2. Locate and remove the slide that is tilted between multiple rack slots. 3. Insert the slide in a new rack for scanning, ensuring it sits level horizontally in one slot. 4. Insert the rack to an empty rack slot for scanning.
No Barcode	<ol style="list-style-type: none"> 1. Check that the slides and rack are inserted correctly. 2. Ensure barcodes meet specifications and the minimum quality requirements described in the scanner user's guide.
No Tissue	<ol style="list-style-type: none"> 1. Verify there is tissue on the slide. 2. Take note of the slide number. 3. Rotate and remove the rack to access the slide. 4. Remove the slide from the rack, and then clean the slide. 5. Re-insert the slide into a new rack and scan it again. 6. If the issue persists, check for slide preparation errors.

Error Message	What to do
No Macro Focus	<ol style="list-style-type: none">1. Check the slides and rack are inserted correctly. See page 13.2. Check that the slide tray is clean.3. Check the stain quality.4. Check that the slide and coverslip meet the requirements described in the scanner Specifications document.5. Check for common slide preparation errors. See <i>“Slide Preparation Checklists”</i> on page 12.
Image Quality QC	<ol style="list-style-type: none">1. Review the scanned slide image in your viewing software.2. Check for common slide preparation issues. See <i>“Slide Preparation Checklists”</i> on page 12.3. Scan the slide again. When the scan is finished, do not remove the rack from the scanner.4. Review the newly scanned slide image in your viewing software.5. If the issue persists, display the slide in Slide View, and tap Scan Entire Slide. (To scan the full slide area for a rack of slides, see page 22.)6. Check if other slides are in focus.7. If all slides are out of focus, clean the objective. (See the “Maintenance” chapter in the scanner user’s guide.)

Error Message	What to do
Image Transfer Error - Pending Retry	<p data-bbox="318 150 781 176">Error message appears on some slides:</p> <p data-bbox="318 205 786 269">The system often resolves the issue without intervention.</p> <ol data-bbox="318 288 860 481" style="list-style-type: none"><li data-bbox="318 288 834 352">1. If all slides in the rack are finished scanning, remove the rack.<li data-bbox="318 370 781 396">2. Check for the image in eSlide Manager.<li data-bbox="318 414 860 481">3. If necessary, rescan the slides that are missing from eSlide Manager. <p data-bbox="902 150 1336 176">Error message appears on all slides:</p> <p data-bbox="902 205 1219 231">The Lab Administrator should:</p> <ol data-bbox="902 251 1507 519" style="list-style-type: none"><li data-bbox="902 251 1484 352">1. Check connectivity from the scanner to the DICOM server, and the DICOM server to your site's image storage location.<li data-bbox="902 370 1468 396">2. Check if your site's image storage location is full.<li data-bbox="902 414 1507 519">3. If the issue persists, consult with your organization's IT professionals prior to calling Leica Biosystems Technical Services.

Error Message	What to do				
Aborted	<table><thead><tr><th data-bbox="318 146 862 175">Error message appears on some slides:</th><th data-bbox="902 146 1521 175">Error message appears on all slides:</th></tr></thead><tbody><tr><td data-bbox="318 200 862 394"><ol style="list-style-type: none">1. Check for damage or common slide preparation issues. (See page 12.)2. Clean the slide.3. Insert the slide into a different rack and scan it again.</td><td data-bbox="902 200 1521 582"><ol style="list-style-type: none">1. Remove any completed slide racks from the carousel.2. Open the cover and access the interior. (See page 26.)3. If there is a slide on the stage, remove it. (See page 28, step 2.)4. Close the scanner cover.5. Shut down the scanner (see page 24.)6. Turn the scanner back on using the On/Off switch.7. Allow the scanner to scan any remaining racks.</td></tr></tbody></table>	Error message appears on some slides:	Error message appears on all slides:	<ol style="list-style-type: none">1. Check for damage or common slide preparation issues. (See page 12.)2. Clean the slide.3. Insert the slide into a different rack and scan it again.	<ol style="list-style-type: none">1. Remove any completed slide racks from the carousel.2. Open the cover and access the interior. (See page 26.)3. If there is a slide on the stage, remove it. (See page 28, step 2.)4. Close the scanner cover.5. Shut down the scanner (see page 24.)6. Turn the scanner back on using the On/Off switch.7. Allow the scanner to scan any remaining racks.
Error message appears on some slides:	Error message appears on all slides:				
<ol style="list-style-type: none">1. Check for damage or common slide preparation issues. (See page 12.)2. Clean the slide.3. Insert the slide into a different rack and scan it again.	<ol style="list-style-type: none">1. Remove any completed slide racks from the carousel.2. Open the cover and access the interior. (See page 26.)3. If there is a slide on the stage, remove it. (See page 28, step 2.)4. Close the scanner cover.5. Shut down the scanner (see page 24.)6. Turn the scanner back on using the On/Off switch.7. Allow the scanner to scan any remaining racks.				

Error Code 1007

Internal storage full. Cannot send images to DICOM converter

The Lab Administrator should perform these steps.

1. Ensure the LAN cables are connected at the scanner LAN port and at the SAM server.
2. Run network diagnostics.
3. Ensure the DICOM server is running. Restart the DICOM server if necessary.
4. If issue persists, contact Leica Biosystems Technical Services.

Error Code 2000

Slide handling error at slide stage, rack, or pusher

1. Open the scanner cover to access the interior. See page 26.
2. Take photos of the obstruction for Leica Biosystems Technical Services.
3. Check if there is a slide on the stage or partially on the stage.
4. Carefully remove the slide from the stage without touching the surrounding components.
5. Check for obstruction near the slide stage, rack, and pusher.
6. If possible, carefully remove the slide that is causing the obstruction, and continue to step 8.
7. If you cannot remove the obstruction or if the issue persists, call Leica Biosystems Technical Services.

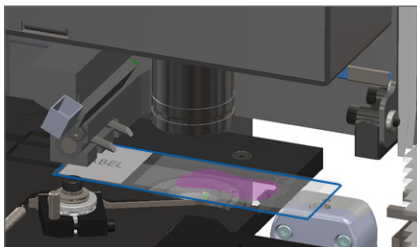

CAUTION: Restarting the scanner with a slide on the stage may damage the slide.

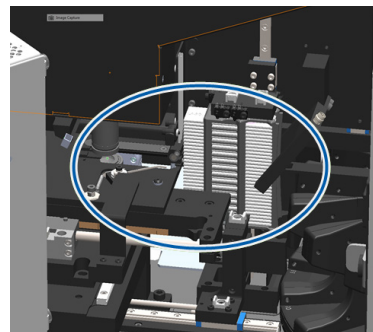



WARNING: Do not attempt to recover broken slides. Call Leica Biosystems Technical Services.

8. Check the slide for preparation issues, such as over-hanging coverslips and label issues.
 - a. If there are no slide preparation issues, re-insert the slide in an available rack for scanning.
 - b. If there are slide preparation issues, correct the slide issues before scanning.
9. If the pusher is extended, return the pusher to the safe position as described in *“Return Pusher to Safe Position”* on page 27.
10. Close the scanner cover. (See page 26.)
11. Tap **Restart Scanner**.

Error Code 2001

Slide handling error at rack gripper, lift, or carousel

1. Open the scanner cover to access the interior. See page 26.
2. Take photos of the obstruction for Leica Biosystems Technical Services.
3. Check if there is a slide on the stage or partially on the stage.
4. Carefully remove the slide from the stage without touching the surrounding components.
5. Check for an obstruction near the rack gripper, lift, and carousel.
6. Close the scanner cover. See page 26.
7. Call Leica Biosystems Technical Services.

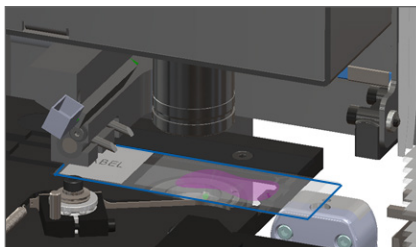

CAUTION: Restarting the scanner with a slide on the stage may damage the slide.

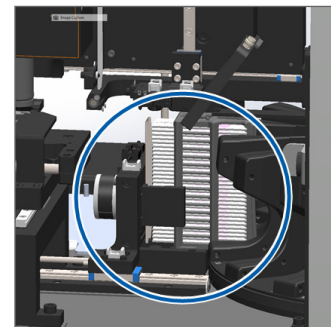

Error Code 9000

Scanner cover is open.

1. Slide the cover to the closed position, making sure the cover aligns with rear latches and clicks closed:

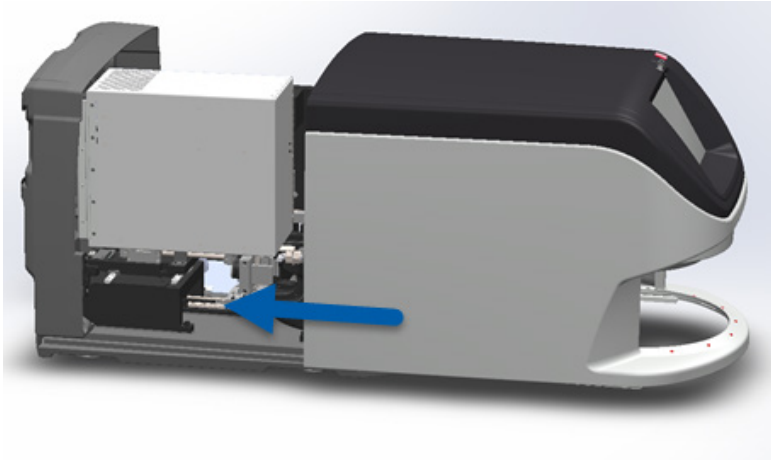

Broken Slides Inside the Scanner



WARNING: Do not attempt to recover broken slides. Call Leica Biosystems Technical Services.

Take photos of the location of the damage. Leica Biosystems Technical Services may request the photos when providing assistance.

Index

A

Auto-Image QC 10

B

barcode error 33

barcodes 12

broken slides in scanner 42

buttons 11

C

cannot find tissue 33

cannot macro focus 34

carousel 9

close cover 26

continuous loading 10

cover, open and close 26

coverslips 12

E

error codes and resolutions 29

error, rack 17

F

firmware version, locate 25

H

Home screen 7

I

icon glossary 11

image quality 10

insert slides 13

L

labels, slide 12

legend, rack status 17

light curtain, safety 9

load slides 13

M

macro focus error 34

macro image 20

magnification 10

maintenance

checklists 23

schedule 23

N

no barcode 33

no macro focus 34

O

open cover 26

P

pinch point, carousel 9

preparation, slide 12

priority scan 16

pusher, position 27

Q

queue, scan 20

R

rack

error 17

load in carousel 14

load slides in 13

order 20

unload 15

view 19

warnings 21

remove rack 15

restart scanner

after error 28

daily maintenance 24

rotate 15

rotation, carousel 9

S

scan entire slide

single slide 20

whole rack 22

scan error 17

scan magnification 10

scanner

restart 24

shutdown 24

scanner overview 6

scan settings 10

scan slides 13

schedule, maintenance 23

serial number, locate 25

shutdown scanner 24

slide

labels 12

preparation 12

slide handling error 38, 40

slides broken in scanner 42

slide status 19

slide view 20

software version, locate 25

statistics 18

status

legend 17

rack 17

scan 17

slide 19

status lights 10

T

tilted slide 33

touchscreen interface 7

troubleshooting 25

U

unload rack 15

V

VPU, open and close 26

W

warnings, rack 21

workflow, scan 8

Revision Record

Rev.	Issued	Sections Affected	Detail
A	April 2022	All	New version for Aperio GT 450 DX product. Based on existing <i>Aperio GT 450 DX Quick Reference Guide</i> , MAN-0443, Revision B

Cautions and Notes

- ▶ **Serious Incidents Reporting** - Any serious incident that has occurred in relation to the Aperio GT 450 DX shall be reported to the manufacturer and the competent authority of the member state in which the user and/or the patient is established.
- ▶ **Specifications and Performance** - For device specifications and information on performance characteristics, refer to the document *Aperio GT 450 DX Scanner Specifications*.
- ▶ **Installation** - Aperio GT 450 DX must be installed by a trained Leica Biosystems Technical Services representative.
- ▶ **Repair** - Repairs may be done only by a trained Leica Biosystems Technical Services representative. After repairs are done, ask the Leica Biosystems technician to perform operation checks to determine the product is in good operating condition.
- ▶ **Accessories** - For information on using Aperio GT 450 DX with third-party accessories such as a Laboratory Information System (LIS) not provided by Leica Biosystems, contact your Leica Biosystems Technical Services representative.
- ▶ **Quality Control** - For information on image quality checks, see the *Aperio GT 450 DX User's Guide*.
- ▶ **Maintenance and Troubleshooting** - For information on maintenance and troubleshooting problems, see the *Aperio GT 450 DX User's Guide*.
- ▶ **Cybersecurity** - Be aware that workstations are susceptible to malware, viruses, data corruption, and privacy breaches. Work with your IT administrators to protect workstations by following your institution's password and security policies. For Aperio recommendations on protecting your workstations and servers, see the document *Aperio GT 450 DX IT Manager and Lab Administrator Guide*. If a suspected Aperio GT 450 DX cybersecurity vulnerability or incident is detected, contact Leica Biosystems Technical Services for assistance.

- ▶ **Training** - This manual is not a substitute for the detailed operator training provided by Leica Biosystems or for other advanced instruction.
- ▶ **Safety** - Safety protection may be impaired if this device is used in a manner not specified by the manufacturer.



*For additional information on this product, including intended use and symbols glossary, please refer to the primary instructions for use, **Aperio GT 450 DX User's Guide**.*

[LeicaBiosystems.com/Aperio](https://www.LeicaBiosystems.com/Aperio)



Copyright © 2022 Leica Biosystems Imaging, Inc.
All Rights Reserved. LEICA and the Leica logo are registered trademarks of Leica Microsystems IR GmbH.
Printed in the U.S.

MAN-0477 Revision A 04/2022