

Leica IP C

Automated printing system for tissue cassettes

Instructions for Use
English

Order No.: 14 0602 80101 - Revision P

Always keep this manual near the instrument.
Read carefully before working with the instrument.

CE



The information, numerical data, notes and value judgments contained in this Instructions for Use represent the current state of scientific knowledge and state-of-the-art technology as we understand it following thorough investigation in this field.

We are under no obligation to update the present Instructions for Use periodically and on an ongoing basis according to the latest technical developments, nor to provide our customers with additional copies, updates etc. of this Instructions for Use.

To the extent permitted in accordance with the national legal system as applicable in each individual case, we shall not be held liable for erroneous statements, drawings, technical illustrations etc. contained in this Instructions for Use. In particular, no liability whatsoever is accepted for any financial loss or consequential damage caused by or related to compliance with statements or other information in this Instructions for Use.

Statements, drawings, illustrations and other information regarding the contents or technical details of the present Instructions for Use are not to be considered warranted characteristics of our products.

These are determined only by the contract provisions agreed between ourselves and our customers.

Leica reserves the right to change technical specifications as well as manufacturing processes without prior notice. Only in this way is it possible to continuously improve the technology and manufacturing techniques used in our products.

This document is protected under copyright laws. All copyrights to this documentation are held by Leica Biosystems Nussloch GmbH.

Any reproduction of text and illustrations (or of any parts thereof) by means of print, photocopy, microfiche, web cam or other methods – including any electronic systems and media – requires express prior permission in writing by Leica Biosystems Nussloch GmbH.

For the instrument serial number and year of manufacture, please refer to the nameplate on the back of the instrument.



Leica Biosystems Nussloch GmbH

Heidelberger Strasse 17 - 19

69226 Nussloch

Germany

Tel.: +49 - (0) 6224 - 143 0

Fax: +49 - (0) 6224 - 143 268

Web: www.LeicaBiosystems.com

Table of Contents

1. Important Information	6
1.1 Symbols and their meanings.....	6
1.2 Qualification of personnel.....	10
1.3 Intended use of instrument.....	10
1.4 Instrument type	10
2. Safety	11
2.1 Safety instructions.....	11
2.2 Warnings.....	12
3. Instrument Components and Specifications.....	14
3.1 Overview – instrument.....	14
3.2 Technical data.....	17
3.3 Print specifications.....	19
3.3.1 Requirements for cassettes.....	19
3.3.2 Print specifications.....	21
3.3.3 Printing bar code	23
4. Instrument Setup.....	26
4.1 Site requirements	26
4.2 Unpacking the instrument.....	27
4.2.1 Installing the printer	29
4.3 Standard delivery.....	29
4.4 Installing the manual unload station	30
4.5 Automated unload station (optional).....	31
4.6 Installing/exchanging the flash bulb	32
4.7 Filling and inserting the magazines	35
4.8 Electrical connection	40
4.9 Exchanging the transport cartridge for an ink cartridge	41
4.10 Installing the printer driver.....	48
5. Operation.....	49
5.1 Control panel functions.....	49
5.2 Display indications	55
5.3 Alarm functions.....	57
5.4 Printer driver settings	58
6. Cleaning and Maintenance.....	62
6.1 Cleaning the instrument.....	62
6.2 Cleaning the print head.....	64
6.3 Exchanging the cartridge	68
6.3.1 Removing the used ink cartridge	68
6.3.2 Inserting the new ink cartridge	68
6.3.3 Removing the protective cap.....	69
6.4 General maintenance.....	69
6.5 Storing the instrument	69
6.6 Transporting the instrument	74

7.	Troubleshooting	75
7.1	Malfunctions.....	75
7.2	Status messages.....	76
7.3	Error messages	77
7.4	Changing the flash bulb	80
7.5	Power failure	81
7.6	Replacing the secondary fuses.....	81
8.	Warranty and Service	83
9.	Decontamination Certificate	84

1 Important Information

1. Important Information

1.1 Symbols and their meanings



Warning

Leica Biosystems GmbH assumes no liability for consequential loss or damage due to failure to observe the following instructions, particularly in relation to transportation and package handling, and failure to observe the instructions for handling the instrument carefully.

Symbol:



Title of the symbol:

Warning

Description:

Warnings appear in a gray box and are marked by a warning triangle.

Symbol:



Title of the symbol:

Note

Description:

Notes, i. e. important user information, appear in a gray box and are marked by an information symbol.

Symbol:

→ "Fig. 7 - 1"

Title of the symbol:

Item number

Description:

Item numbers for numbering illustrations. Numbers in red refer to item numbers in illustrations.

Symbol:

START

Title of the symbol:

Function key

Description:

Function keys to be pressed on the instrument are displayed as capital letters and bold, black text.

Symbol:

Ready

Title of the symbol:

Software key and/or Display Messages

Description:

Software keys to be pressed on the display and/or messages on the display are displayed as bold, gray text.

Symbol:



Title of the symbol:

Warning, hot surface

Description:

Instrument surfaces which become hot during operation are marked with this symbol. Avoid direct contact to prevent risk of burning.

Symbol:



Title of the symbol:

Warning, risk of electric shock

Description:

Instrument surfaces or areas which become energized during operation are marked with this symbol. Therefore, direct contact is to be avoided.

Symbol:



Title of the symbol:

Manufacturer

Description:

Indicates the manufacturer of the medical product.

Symbol:











Title of the symbol:









Manufacturing date

Description:

Indicates the date when the medical device was manufactured.

Symbol:	Title of the symbol:	RCM Compliance Mark
	Description:	The Regulatory Compliance Mark (RCM) indicates a device's compliance with applicable ACMA technical standards of New Zealand and Australia - that is, for telecommunications, radio communications, EMC and EME.
Symbol:	Title of the symbol:	CE Label
	Description:	The CE marking is the manufacturer's declaration that the medical product meets the requirements of the applicable EC directives and regulations.
Symbol:	Title of the symbol:	UKCA Label
	Description:	The UKCA (UK Conformity Assessed) marking is a new UK product marking that is used for goods being placed on the market in Great Britain (England, Wales and Scotland). It covers most goods which previously required the CE marking.
Symbol:	Title of the symbol:	UK Responsible Person
	Leica Microsystems (UK) Limited Larch House, Woodlands Business Park, Milton Keynes England, United Kingdom, MK14 6FG	The UK Responsible Person acts on behalf of the non-UK manufacturer to carry out specified tasks in relation to the manufacturer's obligations.
Symbol:	Title of the symbol:	CSA Statement (Canada/USA)
	Description:	The CSA test mark means that a product has been tested and fulfills the applicable safety and/or performance standards, including the relevant standards defined or administered by the American National Standards Institute (ANSI), Underwriters Laboratories (UL), the Canadian Standards Association (CSA), the National Sanitation Foundation International (NSF) and others.
Symbol:	Title of the symbol:	China ROHS
	Description:	Environmental protection symbol of the China RoHS directive. The number in the symbol indicates the "Environment-friendly Use Period" of the product in years. The symbol is used if a substance restricted in China is used in excess of the maximum permitted limit.
Symbol:	Title of the symbol:	WEEE Symbol
	Description:	The WEEE symbol, indicating separate collection for WEEE - Waste of electrical and electronic equipment, consists of the crossed-out wheeled bin (§ 7 ElektroG).
Symbol:	Title of the symbol:	Alternating current
		

1 Important Information

Symbol: 	Title of the symbol: Description:	Article number Indicates the manufacturer's catalog number so that the medical device can be identified.
Symbol: 	Title of the symbol: Description:	Serial number Indicates the manufacturer's serial number so that a specific medical device can be identified.
Symbol: 	Title of the symbol: Description:	Consult Instructions for Use Indicates the need for the user to consult the Instructions for Use.
Symbol: 	Title of the symbol: Description:	ON (Power) The power supply is connected upon pushing the power switch .
Symbol: 	Title of the symbol: Description:	OFF (Power) The power supply is disconnected upon pushing the power switch .
Symbol: 	Title of the symbol: Description:	Fragile, handle with care Indicates a medical device that can be broken or damaged if not handled carefully.
Symbol: 	Title of the symbol: Description:	Keep dry Indicates a medical device that needs to be protected from moisture.
Symbol: 	Title of the symbol: Description:	Stacking limit by number To indicate that the items shall not be vertically stacked beyond the specified number, either because of the nature of the transport packaging or because of the nature of the items themselves.
Symbol: 	Title of the symbol: Description:	This way up To indicate correct upright position of the transport package.

Symbol:

Transport temperature range:

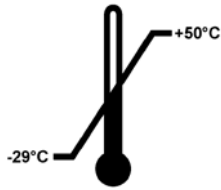

Title of the symbol:

Description:

Temperature limit for transport

Indicates the transport temperature limits to which the medical device can be safely exposed.

Symbol:

Storage temperature range:

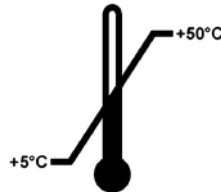

Title of the symbol:

Description:

Temperature limits for storage

Indicates the storage temperature limits to which the medical device can be safely exposed.

Symbol:



Title of the symbol:

Description:

Humidity limitation for storage and transport

Indicates the storage and transport range of humidity to which the medical device can be safely exposed.

Symbol:

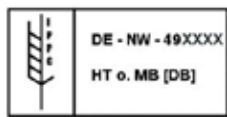

Title of the symbol:

Description:

IPPC

The IPPC symbol includes

- IPPC symbol
- Country code to ISO 3166, e.g. DE for Germany
- Regional identifier, e.g. NW for North Rhine-Westphalia
- Registration number, unique number beginning with 49.
- Treatment method, e.g. HT (heat treatment)

Symbol:



Title of the symbol:

Description:

Inflammable (Packaging Label)

Package labeling in accordance with German Hazardous Freight Ordinance Road and Rail (GGVSE)/ European Agreement concerning the International Carriage of Dangerous Goods by Road (ADR) for transporting hazardous goods.

Class 3: "FLAMMABLE LIQUID"

Symbol:



Title of the symbol:

Description:

Tilt Indicator

Indicator to monitor whether the shipment has been transported and stored in upright position according to your requirements. With a pitch of 60 ° or more, the blue quartz sand flows into the arrow-shaped indicator window and sticks there permanently. Improper handling of the shipment is immediately detectable and can be proven definitively.

1.2 Qualification of personnel

- The Leica IP C may be operated only by trained laboratory personnel.
- The instrument may be operated only according to the instructions contained in this Instruction for Use. The instrument is intended for professional use only.

1.3 Intended use of instrument

Leica IP C printer system for standard histology cassettes.

- The instrument has been designed for use in pathology, histology, cytology, toxicology and similar laboratories, and there only for printing tissue cassettes.
- Imprints of adequate quality and resistance to subsequent processing in tissue processors can only be guaranteed when using the cassettes and reagents specified in ([→ p. 19 – 3.3 Print specifications](#)).
- The instrument may be operated only according to the instructions contained in this Instructions for Use.

Any other use of the instrument is considered improper



Note

Proper and intended use includes the observance of all instructions in the operating manual and compliance with all inspection and maintenance instructions.

1.4 Instrument type

All information provided in these Instructions for Use applies only to the instrument type indicated on the title page. A name plate indicating the instrument serial number is attached to the back of the instrument.

2. Safety



Warning

The safety and caution notes in this chapter must be observed at all times.

Make sure to read these instructions, even if you are already familiar with the operation and use of other products.

2.1 Safety instructions

These Instructions for Use include important instructions and information related to the operating safety and maintenance of the instrument.

The Instructions for Use are an important part of the product, and must be read carefully prior to startup and use and must always be kept near the instrument.

This instrument has been built and tested in accordance with the safety regulations for electrical measuring, control, regulating and laboratory devices.

To maintain this condition and ensure safe operation, the user must observe all notes and warnings contained in these Instructions for Use.



Note

These Instructions for Use must be appropriately supplemented as required by the existing regulations on accident prevention and environmental safety in the operator's country.

For current information about applicable standards, please refer to the CE declaration of conformity on our Internet site:

<http://www.LeicaBiosystems.com>



Warning

The protective devices on both instrument and accessories may neither be removed nor modified. Only authorized and qualified service personnel may repair the instrument and access the instrument's internal components.

Use only the provided power cord. It must not be replaced with a different power cord. If the power plug does not fit in your socket, contact our service.

Residual risks:

The instrument has been designed and constructed with the latest state-of-the-art technology and according to recognized standards and regulations with regard to safety technology. Operating or handling the instrument incorrectly can place the user or other personnel at risk of injury or can cause damage to the instrument or other property. The machine may be used only as intended and only if all of its safety features are in proper working condition. Malfunctions that impede safety must be remedied immediately.

2.2 Warnings

The safety devices installed in this instrument by the manufacturer only constitute the basis for accident prevention. Operating the instrument safely is, above all, the responsibility of the owner, as well as the designated personnel who operate, service or repair the instrument.

To ensure trouble-free operation of the instrument, make sure to comply with the following instructions and warnings.

Warnings – Transport and Installation



Warning

- Once unpacked, the instrument may be transported only in an upright position.
- Do not expose the instrument to direct light (window, bulbs with strong light)!
- Only connect the instrument to a grounded power socket. Do not interfere with the grounding function by using an extension cord without a ground wire.
- Do not operate the instrument in rooms with explosion hazard.
- Condensation water may form in the instrument if there is an extreme difference in temperature between the warehouse and the installation site and if air humidity is high. If this is the case, wait at least two hours before switching on the instrument. Failure to adhere to this waiting period may result in damage to the instrument.

Warnings – Markings on the instrument itself



Warning

Markings on the instrument showing the warning triangle indicate that the correct operating instructions (as defined in this Instructions for Use) must be followed when operating or replacing the item marked.

Failure to adhere to these instructions may result in an accident, personal injury, damage to the instrument or accessory equipment.

Some instrument surfaces, which become hot during operation are marked with this warning label:



Touching these surfaces may cause burns.

Warnings – Instrument operation**Warning**

- The instrument may be operated by trained laboratory personnel only. It must only be operated for the purpose of its designated use and according to the instructions contained in these Instructions for Use.
- The instrument is de-energized after disconnection of the power supply through the power cord (power supply circuit breaker) - in emergencies, disconnect the power plug.
- Do not touch the chute during operation. Risk of injury.
- Do not open the reflector flap of the flash bulb while the instrument is **ON** – risk of burns and blinding.
- The device operator is obligated to conform to the local workplace limit values and to document them.

Warnings – Cleaning and maintenance**Warning**

- Before any maintenance, switch off the instrument and unplug it from power supply.
- To clean the exterior surfaces, use a mild and ph-neutral commercial household cleaner. You may not use: Alcohol, cleaning materials containing alcohol (glass cleaner!), abrasives or solvents containing acetone or xylene! The painted surfaces and the control panel of the instrument are not resistant to xylene or acetone!
- While working and during cleaning, no liquid may get into the interior of the instrument.

3 Instrument Components and Specifications

3. Instrument Components and Specifications

3.1 Overview – instrument

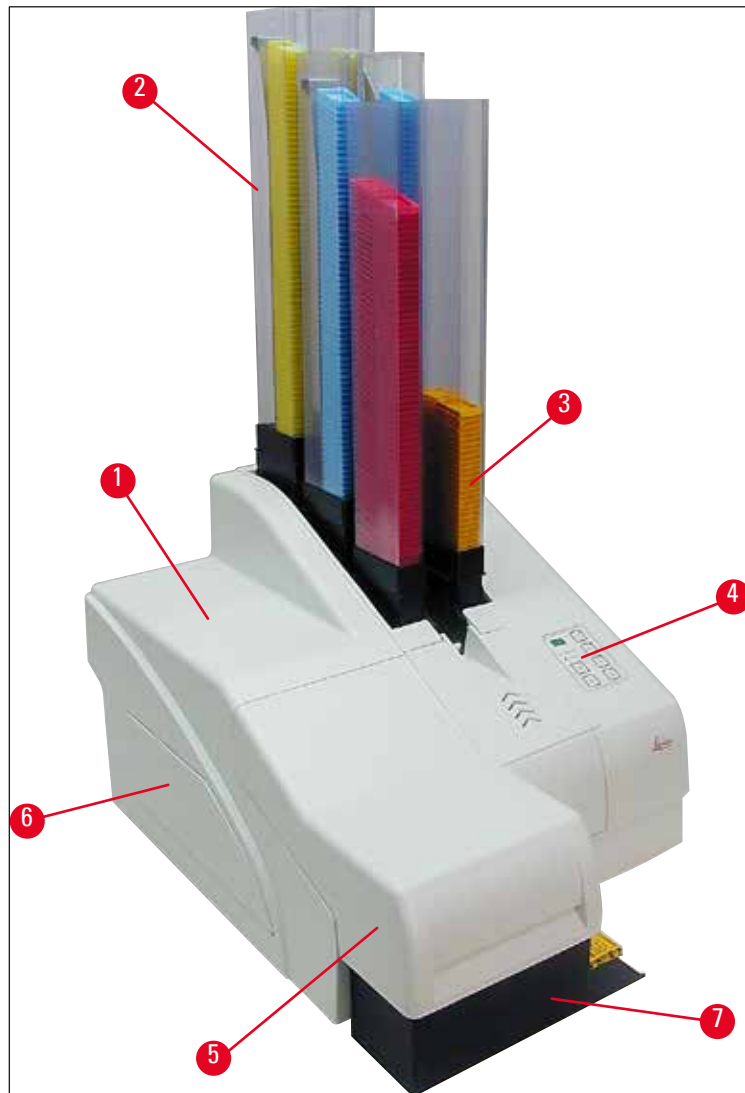

Fig. 1

- 1 Basic instrument
- 2 Cassette magazines
- 3 Magazine no. 1
- 4 Control panel
- 5 Lid
- 6 Cover - cartridge slot
- 7 Unload station (manual)

Front view without lid

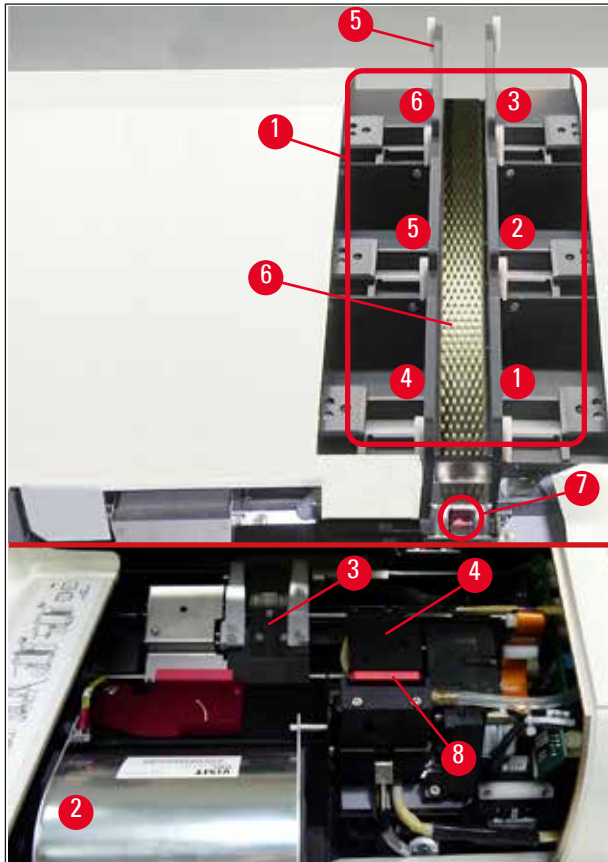

Fig. 2

- 1 Magazine receptacles pos. 1 - 6
- 2 Cover – flash bulb
- 3 Cassette carrier (clamp)
- 4 Print head
- 5 Magazine holder
- 6 Feeding chute with cover
- 7 Transfer point: chute --> cassette carrier, with sensor
- 8 Replacement plate with sealing lip

3 Instrument Components and Specifications

Rear panel and electrical connections

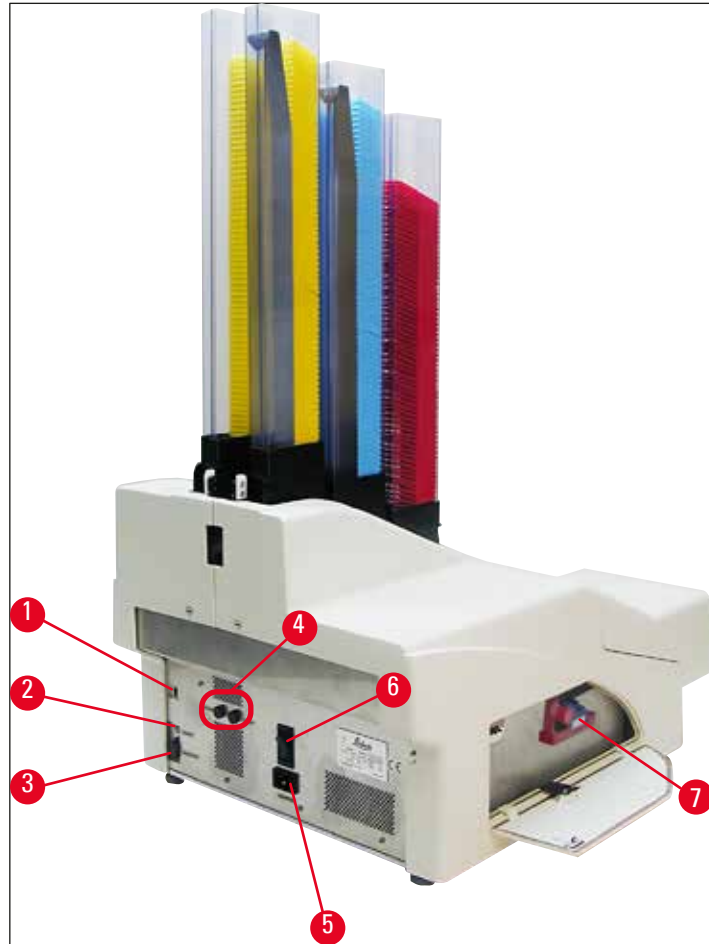

Fig. 3

- 1 DIL switch
- 2 External alarm jack
- 3 Socket for printer cable
- 4 Secondary fuses
- 5 Power supply connection
- 6 Main switch
- 7 Transport cartridge / ink cartridge



Note

Attention for (→ "Fig. 3-7"). The instrument is delivered with the transport cartridge installed! Prior to operation, the transport cartridge must be exchanged for an ink cartridge (→ p. 41 – 4.9 Exchanging the transport cartridge for an ink cartridge).

3.2 Technical data

General

Approvals:	The instrument-specific approval marks are located at the rear panel of the instrument, next to the name plate.
Nominal supply voltages:	100 to 120 V ~ +/- 10 % 200 to 240 V ~ +/- 10 %
Nominal supply frequencies:	50 to 60 Hz
Mains input fuses:	Circuit breaker T6A
Secondary fuses:	2x T 3.15 A L250 V
Maximum power draw at 100 - 120 V:	4.0 A
Maximum power draw at 200 - 240 V:	2.8 A
Leakage current at 240 V/50 Hz:	ca. 2.4 mA
Power consumption:	700 VA
Overvoltage category to IEC 61010-1:	II
Pollution degree to IEC 61010-1:	2
Means of protection to IEC 61010-1:	Class 1
Degree of protection to IEC 61010-1	IP20
Heat emission:	700 J/s
Operating elevation:	up to max. 2000 m NN
A-weighted noise level, measured at 1 m distance:	< 70 dB (A)
EMC class:	B-B
Interfaces:	DIL switch, External alarm jack, Serial in, Power supply
Climatic conditions for the operation of the instrument:	
Temperature:	+15 °C to +30 °C
Relative humidity:	20 - 85 % - non-condensing
Climatic conditions for the storage and transport of the packaged instrument:	
Temperature (storage):	+5 °C to +50 °C
Temperature (transit):	-29 °C to +50 °C
Relative humidity (transit/storage):	10 - 85 % - non-condensing
BTU (J/s)	700 J/s
Dimensions and weight:	
Dimensions of basic instrument:	
Width x depth:	475 x 650 mm
Height with magazine:	900 mm
Height without magazine:	415 mm
Dimensions with unload station connected:	
Width x depth:	550 x 650 mm
Height with magazine:	990 mm

Height without magazine:	500 mm
Basic instrument empty weight:	approx. 28 kg
Weight, packed:	approx. 65 kg
Unload station empty weight:	approx. 14 kg
Weight, packed:	approx. 32 kg
Performance:	
Load capacity:	up to 6 magazines, up to 80 cassettes per magazine
Printing speed: ¹	
Printing batch jobs:	15 cassettes/minute
Single-cassette printing:	10 s per cassette
Ink cartridge capacity: ²	approx. 60,000 printouts or 3.5 months
Flash bulb lifetime:	approx. 150,000 flashes
Printing:	
Print resolution: ³	360 x 360 dpi / 180 x 180 dpi, adjustable
Printing medium:	Standard histology cassettes max. 28.9 x 80.0 mm (with lid), max. 6.2 mm high
Print formats:	Cassette 35 °, cassette 45 °
Pressure surfaces:	Cassette 35 °: max. 28.2 x 8.0 mm Cassette 45 °: max. 28.2 x 7.1 mm
PC system requirements:	
IBM-compatible PC	
Processor clock frequency:	min. 800 MHz
Main memory (RAM):	min. 256 MB
Hard disk:	min. 6 GB
CD-ROM drive	
1 free serial port	
Operating systems:	Windows 10 (64 bit)

¹) Average value – exact speed in each individual case depends on system configuration and software used.

²) Average values are given; the exact number depends on the print density.

³) Measured in addressable dots per inch.

3.3 Print specifications

Only standard histology cassettes can be used in the Leica IP C. Other cassettes cannot be properly processed.

3.3.1 Requirements for cassettes

A wide variety of standard cassettes may be used in the IP C; however, the following restrictions must be observed:

- Suitable for printing are all standard cassettes (→ p. 17 – 3.2 Technical data) without lids (→ "Fig. 4-1"), of the following dimensions:

Length without lid x width	= max. 41.3 x 28.9 mm
Length with lid x width	= max. 80.0 x 28.9 mm



Fig. 4

- Cassettes with lids attached have to be one-piece units (→ "Fig. 4-2"); the lids must not just be linked to the body by a hinge.
- Cassettes with a flexible hinge cannot be used unless the lid is detached (→ "Fig. 6-2") or closed.
- Cassettes with a closed lid (→ "Fig. 5-1") must be checked to ensure that all four corners of the lid are firmly closed and flat.
- Cassettes with top-mounted lids (→ "Fig. 6-1") cannot be processed.
- For details on how to correctly insert the cassettes into the magazines, please refer to (→ p. 35 – 4.7 Filling and inserting the magazines).

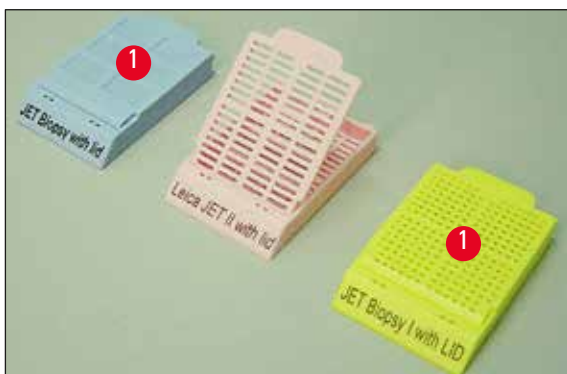

Fig. 5

3 Instrument Components and Specifications

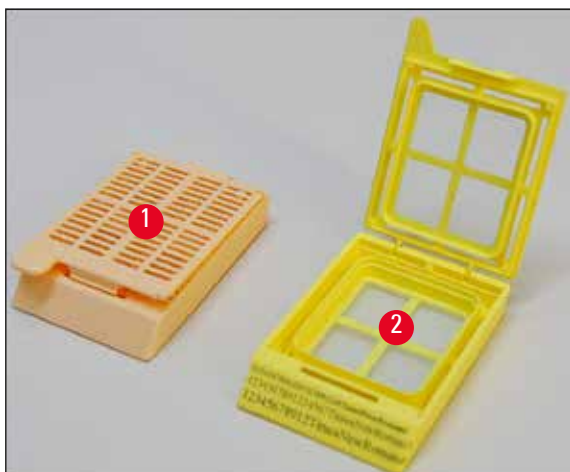

Fig. 6

Recommended print media for the Leica IP C



Note

The use of other print media may result in unsatisfactory print quality and/or jamming of slides/cassettes during the printing process!

If the slides/cassettes you are currently using are not listed below please contact your local Leica representative.

The following cassettes have been successfully tested with the Leica IP C:

Cassette type	Imprinting in Leica IP C
Leica Jet Routine I*	without lid only
Leica Jet Routine II*	with closed lid only
Leica Jet Routine III*	OK
Leica IP Routine VI	OK
Leica ActivFlo Routine I	OK
Leica Jet Bx	with closed lid only
Leica Jet Biopsy	with closed lid only
Leica Jet Biopsy II	OK
Leica Jet Biopsy III	OK (15 bar code characters)
Leica Jet Biopsy IV	OK
Leica IP ActivFlo Biopsy I	OK
Leica IP ActivFlo Biopsy II	without lid only
Leica IP ActivFlo Biopsy III	without lid only
Sakura Tissue Tek III Uni-Cassette System	OK (15 bar code characters)
Sakura Tissue-Tek Paraform Cassette Frames	without lid only

*Recommended for printing barcodes.



Warning

Cassettes of other manufacturers must be tested before use. The test must include the following steps:

- Mechanical compatibility with the instrument. Imprint quality.
- Resistance of the ink against the reagents with which the imprinted cassettes come into contact in the subsequent processes (→ p. 24 – Resistance against reagents).

Important!

Leica Biosystems assumes no responsibility whatsoever for any damages suffered as a consequence of imprints of poor quality or imprints made with non-reagent-resistant ink.

3.3.2 Print specifications

Printing area

The printing area (→ "Fig. 7-1") parameters listed in the table below are defined in the printer driver. A sample barcode printout can be seen in (→ "Fig. 7-2").

Format	Width		Height	
	Dots	mm	Dots	mm
Cassette 35 °	400	28.2	114	8.0
Cassette 45 °	400	28.2	100	7.1



Fig. 7

Cassette type

- There are two different cassette types, which have a different angle, and therefore a different printable area.
- The angle (→ "Fig. 8"), measured from the bottom, can be 35 ° (→ "Fig. 8-1") or 45 ° (→ "Fig. 8-2").
- This must be taken into account in the settings for the printer driver (→ p. 58 – 5.4 Printer driver settings).

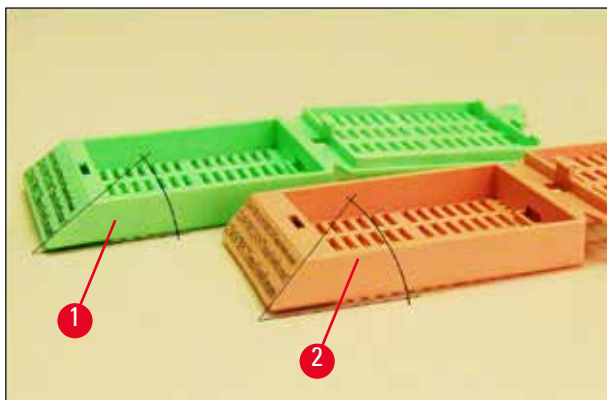

Fig. 8

Print resolution

The print head of the instrument has a preset resolution of 360 dpi in both directions (vertical and horizontal).

Each printed line has a maximum height of 128 dots. This corresponds to a value of 9.03 mm.

In horizontal direction, the printable surface is limited only by the size of the object to be imprinted (→ "Fig. 7").

The above values must be taken into consideration when defining the print area ("paper size") in the application you are going to print from.

Print quality

Quality and resolution of the imprints depend on:

- the cassette material and the dyes used to color the cassette material.
- the surface finish of the cassette imprint field (→ "Fig. 7-1").

The final resolution of the imprints is not only determined by the resolution of the print head.

If the cassette surface is not capable of 360 dpi resolution, "running" ink will lead to poor printing results. In such cases it is better to work at a lower resolution.

The printer driver allows you to change the resolution from 360 dpi to 180 dpi (→ p. 58 – 5.4 Printer driver settings).

3.3.3 Printing bar code

Printing readable bar codes depends on various factors that need to be taken into consideration in order to achieve results suitable for reliable and durable archiving. The main factors influencing the bar code results are:

- printer technology,
- how the bar code is created,
- the type of object being printed on,
- the type of scanner used to read the bar code.

Printer technology

- As a dot matrix printer, this device can handle information only in the form of dots printed or not printed. It is not possible to transmit bar code data or to select specific bar code types or use the printer to create and print the bar code required.

Creating bar codes

- Since there is only limited printing space on the cassettes, the bar code should not contain more information than necessary.
- You should use an error-checking code, which makes it easier for the bar code scanners to recognize possible errors. Some codes even support error correction.
- When calculating and creating bar codes, always take the resolution of the printer into account. The module size is the width of the smallest element of a bar code. Wider bars and spaces are calculated in multiples of the module size. The module size always has to be an entire divisor of the printer resolution, as, due to the technology applied, only whole dots can be printed. Reading errors may occur (even if the print appears to be crisp and correct), if module width and resolution no longer match after conversion.



Warning

Data should never be printed as bar code only, but also as text (line of optical characters above or below the bar code), to ensure that no information is lost for the above reasons.

Requirements for bar code printing

The quality and readability of printed bar codes will depend on several factors that include:

- Texture and quality of the printable surface of the cassettes.
- Color of the selected cassette or slide.
- Barcode style (2D).
- The number and types of characters required in the bar code.
- The quality and resolution capabilities of the bar code reader.

As always, using Leica-recommended print media will produce the highest quality print. However, it is highly recommended that any bar code solution be tested prior to implementation. Please check with your local representative for details on achieving the maximum number of characters with 2D bar codes.

Bar code scanners

The scanning results obtained not only depend on the correct bar code creation and the quality of the cassettes but also on the features of the bar code scanner used.

Features to bear in mind are:

- Reading tolerance:
Difference between actual bar width and nominal module size.
- Light color:
For getting a high contrast the light color of the bar code scanner should be complementary to the color of the cassettes being used.
- Optical resolution:
Must be better than the module size.

Depending on the application, the following features should also be considered:

- Maximum readable distance
- Maximum inclination angle

Leica has successfully tested the ZEBRA DS6707 and DS 8108 bar code scanners.

Resistance against reagents



Warning

Note that each laboratory must perform its own tests to ensure that the ink has no trouble withstanding the subsequent treatment of the cassettes with various reagents.

A wide range of factors beyond Leica's control can have negative effects on the results.

The test conditions stated below can therefore only serve as an outline for individual laboratory test specifications.

The laboratory operating the unit shall bear full responsibility for the legibility of the imprint after processing with reagents.

Test conditions

Imprinted cassettes were tested with a variety of reagents in an environment simulating the conditions present during tissue processing.

List of tested cassette types:

- Leica ActivFlo Routine I
- Leica IP ActivFlo Biopsy I
- Leica IP ActivFlo Biopsy III
- Leica IP Routine VI
- Leica Jet Biopsy III
- Leica Jet Routine III*
- Sakura Tissue Tek III Uni-Cassette System
- Sakura Tissue-Tek Paraform Cassette Frames

*Recommended for printing barcodes.

A variety of colors of all of the above cassette types (although not all colors available of each cassette type) were tested.

An influence of the cassette color on the resistance of the imprint could not be verified.



Warning

It cannot be guaranteed that the ink will be absolutely smudge-proof under all foreseeable laboratory conditions, as stability of the ink against wiping largely depends on the surface structure of the imprint field of the cassettes being imprinted.

Important!

The imprint field of imprinted cassettes should never be touched or wiped while damp.

Take care when removing excess paraffin from cassettes. Scraping may damage the imprint field, making the print illegible.

4. Instrument Setup

4.1 Site requirements



Warning

The instrument must not be operated in areas at risk of explosion.

To ensure proper function of the instrument, it must be set up while maintaining a minimum distance of 10 cm from walls and furniture.

- The instrument requires an installation area of approx. 650 x 550 mm.
- Relative humidity 20 – 85 % maximum - non-condensing
- Room temperature consistently between +15 °C and +30 °C
- Elevation: up to max. 2000 m NN
- The instrument is designed for indoor use only.
- The power plug/circuit breaker must be freely and easily accessible.
- Power supply at a distance no greater than the length of the power cord – an extension cable must not be attached.
- The bench must have a sufficient load capacity and rigidity with respect to the weight of the instrument.
- Avoid vibrations, direct sunlight and large temperature fluctuations. The installation location must be well ventilated, and must contain no sources of ignition of any kind.
- The instrument must be connected to a grounded power socket.
- Only the power cord that is provided with the instrument and that is intended for the local power supply may be used.
- The installation location must be protected against electrostatic discharges.

4.2 Unpacking the instrument



Warning

When the device arrives, check the tilt indicator (→ "Fig. 9") on the package (→ "Fig. 10-1"). If the tip of the arrow is blue, the shipment was not handled as prescribed.

In this case, please mark the shipping documents accordingly and check the shipment for damage!



Fig. 9

1. Unscrew the 8 screws (→ "Fig. 10-2") on the sides of the wooden box and loosen the cover.
2. Remove the accessory box (→ "Fig. 11-1") (includes accessories and packaging material) directly under the lid.
3. Unscrew the 8 screws (→ "Fig. 10-3") at the bottom of the wooden box on the exterior.

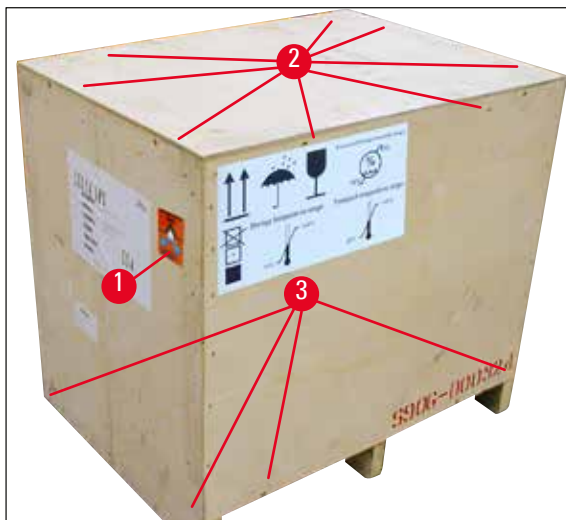

Fig. 10



Fig. 11

4. Remove the interior carton around the instrument.
5. Carefully remove the wooden box from the baseplate.
6. The printer is secured to the wooden floor of the box with 4 plates (→ "Fig. 12-2"). Loosen the two screws (→ "Fig. 12-1") on the base of the instrument. Remove the plates from the bottom.

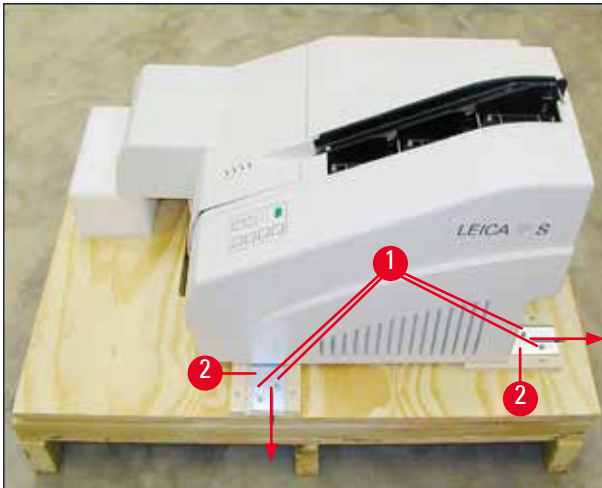

Fig. 12

7. Move the printer from the baseplate on a stable laboratory bench - or, if present, on the automated unload station. Make sure that the stage is leveled!

**Warning**

When unpacking the printer, at least two people (one person on each side of the printer) are required to lift the printer out of the box and place it onto the laboratory bench.

8. When the instrument has been set up at its final area of use, remove the foam transport anchor (→ "Fig. 13-1") (pull upwards).
9. Carefully remove any adhesive tape remnants.



Fig. 13

4.2.1 Installing the printer

- Check the instrument for transport damage (do not switch on in the case of damage!).
- Check all accessories delivered against your order to make sure there are no discrepancies.
- Carry out the following installation steps:
 1. Install the accessories.
 2. Insert the shielding glass.
 3. Insert the flash bulb.
 4. Connect to the power supply.
 5. Exchange the cartridges.
 6. Establish data connection to PC.
 7. Install printer driver.
 8. Fill with cassettes.
 9. Run a test print.

4.3 Standard delivery

The Leica IP C standard equipment consists of the following items:

1	Leica IP C, basic instrument without unload station	14 0602 33206
1	Transport cartridge (in the instrument)	14 0601 42865
1	Unload station (manual), complete	14 0602 35998
1	Accessory kit consisting of:	14 0602 38351
1	Flash bulb	14 0601 37152
6	Sets of cassette magazines (2 packs with 3 sets each)	14 0602 36688
1	Printer cable, serial	14 0601 37044
1	Tool set consisting of:	
1	Slotted screwdriver 4 x 100	14 0170 38504
1	Allen key size 2.5	14 0222 04137
1	"Leica" brush	14 0183 30751
1	Set of replacement fuses consisting of 2 fuses 3.15 A T (5 x 20 mm)	14 6943 03150
2	Shielding glasses	14 0601 42533
1	Transport plates	14 0601 44236
1	International bundle Instructions for Use (incl. English printout and additional languages on a data storage device 14 0602 80200 and printed English Installation Instructions 14 0602 82101)	14 0602 80001



Note

The UV ink cartridge Leica (order number 14 0601 42350) has to be ordered separately. It is shipped in a separate package.

If the supplied local power cord is defective or lost, please contact your local Leica representative.

4 Instrument Setup

Optional accessories

1	Automated unload station for Leica IP C	14 0602 33226
1	Set of cassette trays (pack of 10)	14 0602 33253
1	Magazine holder C for 6 magazines	14 0602 36946
1	Cartridge kit, 280 ml	14 0601 43506
1	Ink cartridge	14 0601 52658
1	Cleaning swabs, pack	14 0601 39637
1	Replacement plate	14 0601 40162
1	Touch PC 15.6"	14 6000 05740
1	Ergotron Stand for Touch PC	14 0605 46856
1	2D Barcode Scanner and stand	14 0605 57409

4.4 Installing the manual unload station

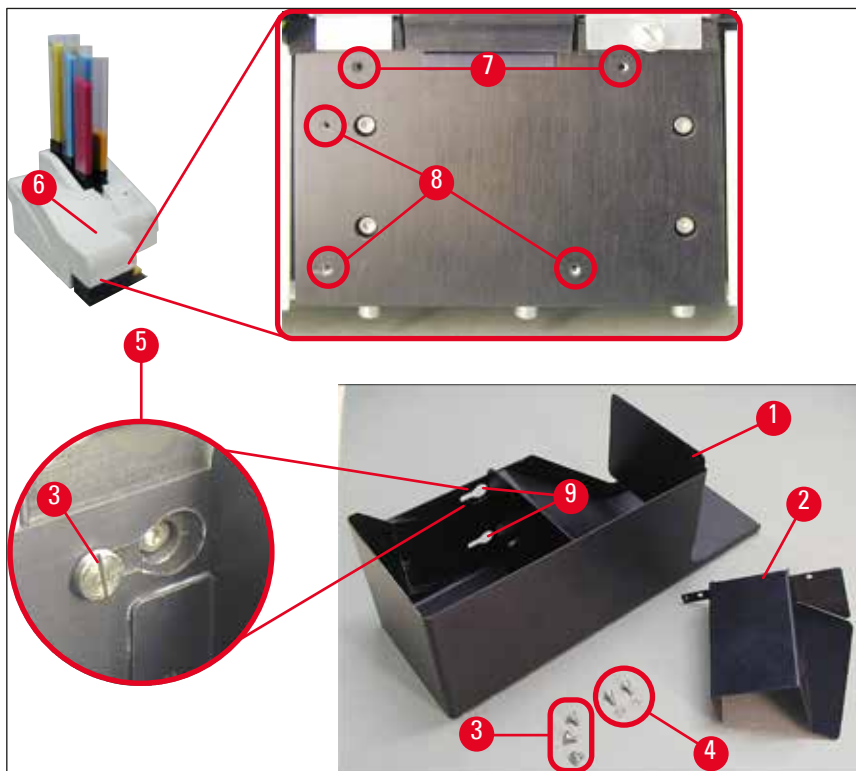

Fig. 14

The unload station supplied consists of:

- Unload station (→ "Fig. 14-1")
- Screening plate (→ "Fig. 14-2")
- Collar screws (3 pcs.) (→ "Fig. 14-3")
- Slotted screws with washers (2 pcs.) (→ "Fig. 14-4")

Install as follows (→ "Fig. 14"):

1. Open lid (→ "Fig. 14-6").
2. There are 5 threaded holes (2 x (→ "Fig. 14-7") and 3 x (→ "Fig. 14-8")) in the installation surface located below the reflector.
3. With a screwdriver, insert 3 collar screws (→ "Fig. 14-3") in tapped holes (→ "Fig. 14-8") as far as they will go.
4. Then, fasten cover (→ "Fig. 14-2") in tapped holes (→ "Fig. 14-7") using the two slotted screws and washers (→ "Fig. 14-4").
5. To fasten the unload station to the instrument, place the wider end of the three oblong holes (→ "Fig. 14-9") over the heads of the three collar screws (→ "Fig. 14-3").



Note

The enlarged detail (→ "Fig. 14-5") shows the correct location of the collar screw once the unload station has been locked in place correctly.

6. Press the unload station against the installation surface, pushing it simultaneously to the right until it locks in place (see enlarged detail (→ "Fig. 14-5")). If the unload station does not easily slide past the shielding cover, slightly lift the front end of the device.
7. Close lid (→ "Fig. 14-6"), make sure the unload station does not obstruct the lid.

4.5 Automated unload station (optional)

Optionally available for the printer is an automated multi-level cassette unload station, where the imprinted cassettes are collected on individually removable and stackable trays (→ "Fig. 15-6") in the order in which they were printed.

The multi-cassette unload station comes complete with 10 trays, all of which can be inserted simultaneously. Each tray holds up to 10 cassettes.

Installing the multi-cassette unload station:

1. Unpack the automated unload station and set it up at the designated location.



Warning

Important! Prior to installation, the printer must be switched off and unplugged from power supply. The manual removal system described in (→ p. 30 – 4.4 Installing the manual unload station) must not be mounted prior to setup. The collar screws (→ "Fig. 14-3") also have to be removed.

2. Place the instrument onto the unload station.



Warning

2 persons are required to do this!

3. Hold the printer on both sides (right and left) and place it so that the two rear bolts (→ "Fig. 15-1") fit into the baseplate first, as shown in (→ "Fig. 15").

4 Instrument Setup

4. Then carefully lower the front part of the printer onto the third bolt (→ "Fig. 15-2") so that the plug connection (→ "Fig. 15-3") locks into place in the printer base plate and the printer remains securely fastened on the unload station.
5. Place the stack of trays (→ "Fig. 15-5") onto the lifting table (→ "Fig. 15-4") of the automated unload station. For details on the lifting table controls, see (→ p. 55 – 5.2 Display indications).



Fig. 15

4.6 Installing/exchanging the flash bulb

Removing the old flash bulb



Warning

Switch the instrument off and unplug it from power supply. Allow the flash bulb to cool off before removing it. Do not handle the flash bulb with bare hands. Use a glove or tissue.

1. Open the lid (→ "Fig. 14-6") to gain access to the reflector (→ "Fig. 16-1").
2. Remove screw (→ "Fig. 16-3") (use screwdriver supplied as part of tool set). Mind the washer (→ "Fig. 16-2").
3. Swing the reflector (→ "Fig. 16-1") upwards.

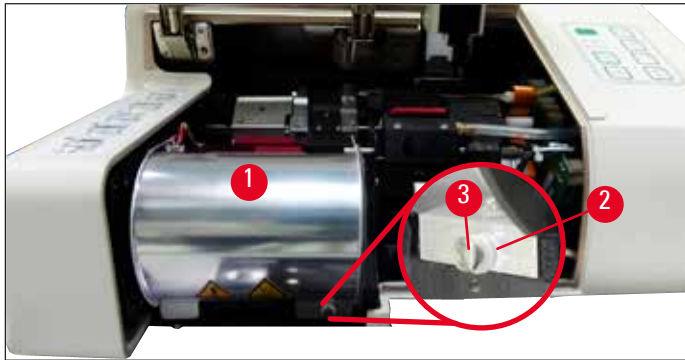

Fig. 16

**Warning**

To insert/remove, hold the flash bulb as shown in (→ "Fig. 17") (left). Do not touch it as shown in (→ "Fig. 18").

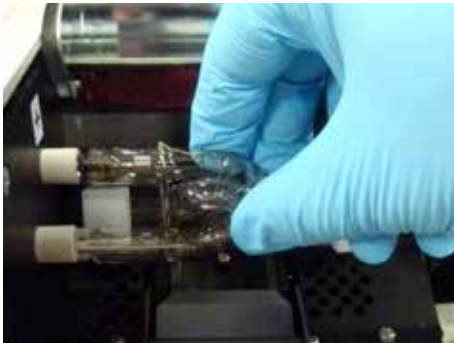

Fig. 17



Fig. 18

4. Carefully pull out the old flash bulb (→ "Fig. 19-1") straight to the right, do not twist it. If the flash bulb cannot be pulled out easily, gently rock it back and forth to get it unseated from the socket.
5. Make sure the contact spring (→ "Fig. 19-2")/(→ "Fig. 20-4") is removed from the ignition wire of the bulb (→ "Fig. 21-1") (See also (→ "Fig. 20").

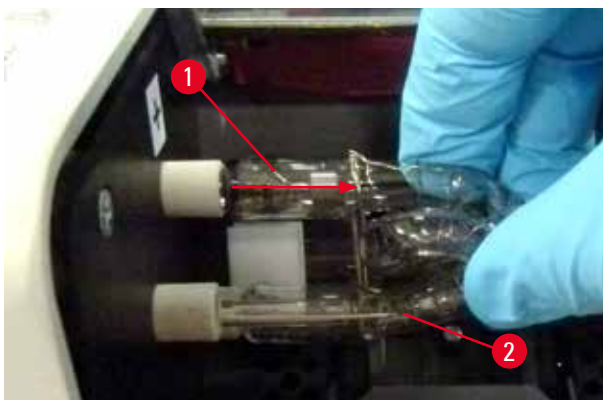

Fig. 19

Inserting the new flash bulb

1. First insert a shielding glass (→ "Fig. 20-1") into the two holders (→ "Fig. 20-2").

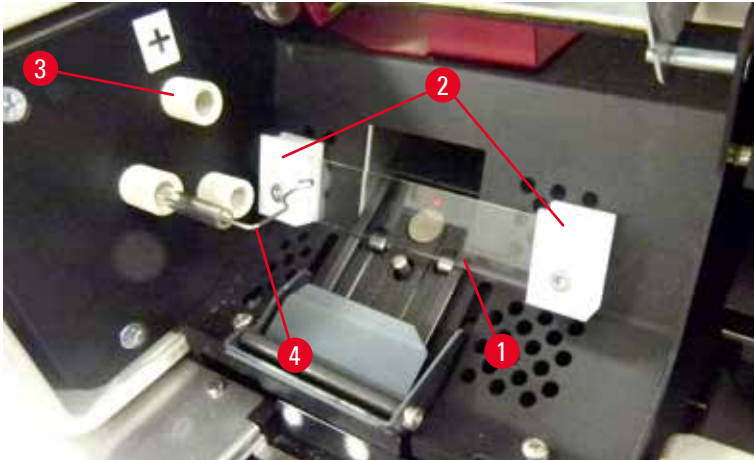

Fig. 20

2. Insert the new flash bulb (→ "Fig. 21") into socket (→ "Fig. 20-3"); then push it carefully inwards as far as it will go (→ "Fig. 23") (the polarity marker (+) must not be visible any longer). If necessary, move flash bulb gently up and down.

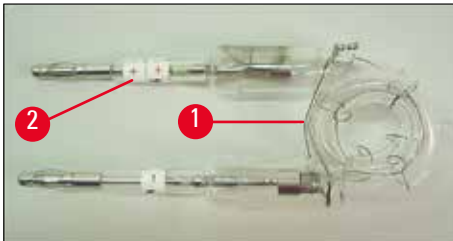

Fig. 21

3. Make sure that the bulb is inserted correctly. The electrode marked with + (→ "Fig. 22-1") has to be inserted into the socket (→ "Fig. 20-3") with the same mark (→ "Fig. 22-2").



Caution

If the bulb electrodes are inserted the wrong way, the flash bulb will still function, but the bulb's life will be considerably reduced.

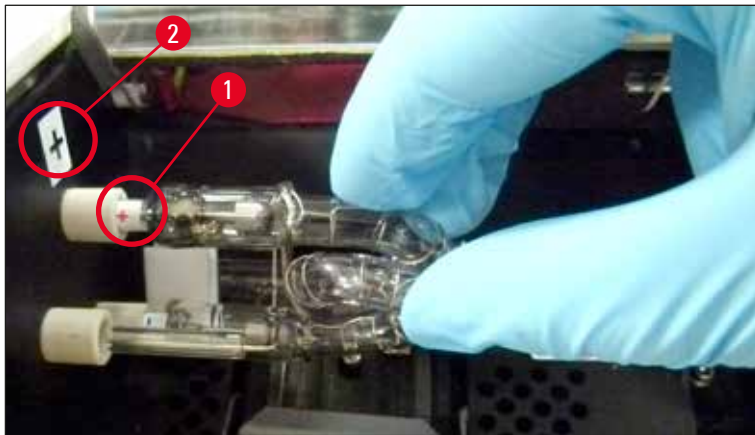

Fig. 22

4. The contact spring (→ "Fig. 23-1") has to touch the ignition wire (→ "Fig. 23-2") of the bulb after being inserted.

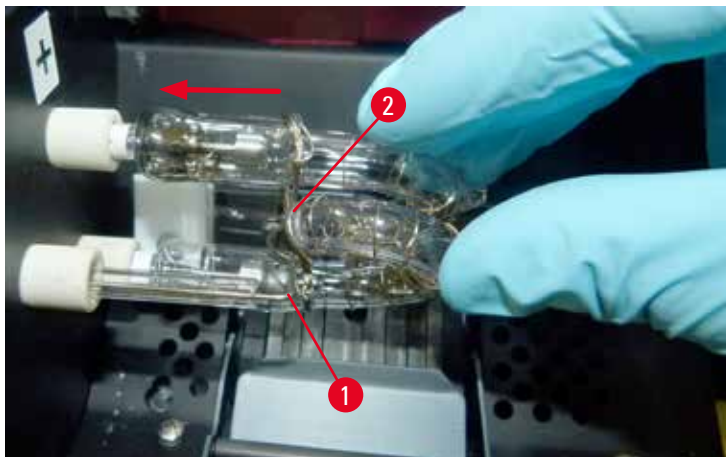

Fig. 23

5. Swing the reflector downwards. Reinsert and retighten screw (→ "Fig. 16-3").
6. Close lid (→ "Fig. 14-6") of the instrument again.

4.7 Filling and inserting the magazines

Inserting the strips

Depending on the type of cassette used, additional inserts must be placed into the magazine (→ "Fig. 24-3") to guide the cassettes properly:

This includes:

Metal insert (→ "Fig. 24-2")

Adhesive strip (2 mm thick) (→ "Fig. 24-1")

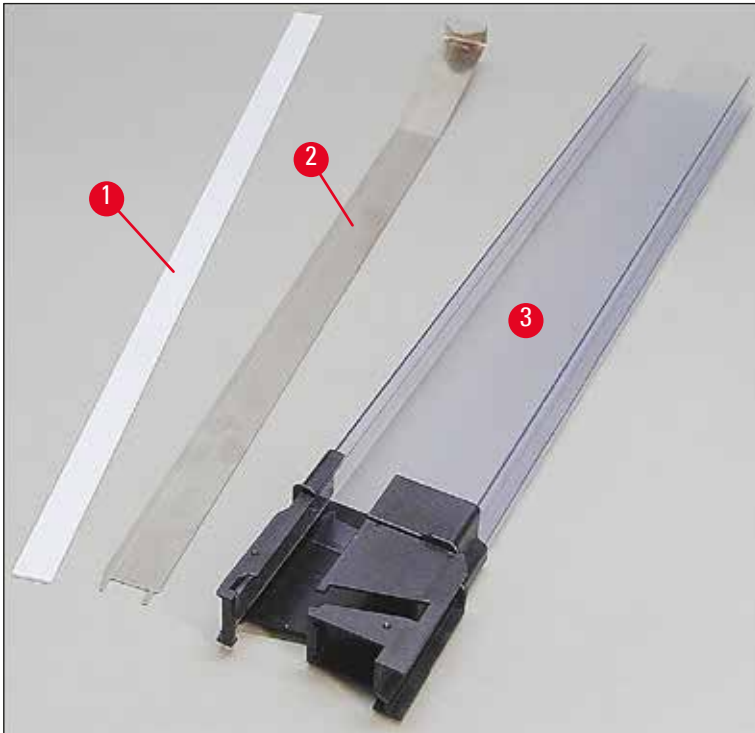

Fig. 24

Adhesive strip 2 mm (→ "Fig. 24-1")

1. Remove protective foil and attach adhesive strip (→ "Fig. 24-1") in magazine so that it is centered in the front part of the magazine (→ "Fig. 25-1") and fits flush against the bottom of the magazine foot (→ "Fig. 25-2").

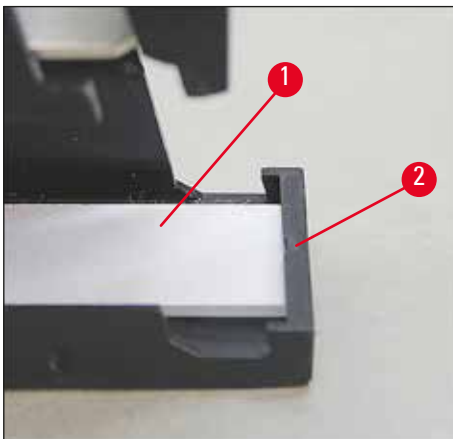

Fig. 25

Metal strip

1. Insert the metal strip (→ "Fig. 24-2") so that the angled part (→ "Fig. 26-3") touches the back panel (→ "Fig. 26-2") of the magazine (→ "Fig. 26-1").

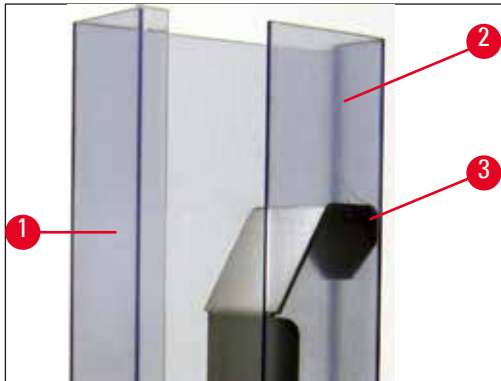

Fig. 26

2. Then push the metal insert downwards until the two plugs (→ "Fig. 27-1") snap into the two grooves (→ "Fig. 27-2") in the magazine foot (→ "Fig. 27-3").

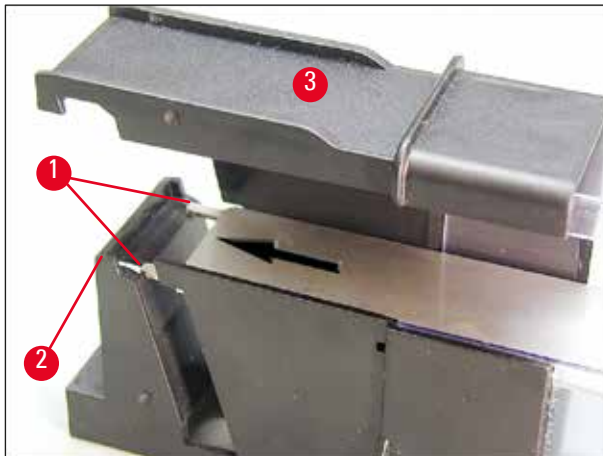

Fig. 27

Filling and inserting the magazines

The following table shows which cassette size should be used with which inserts.

Cassette size (length)		Insert
without lid or with closed lid:	≥ 41.3 mm	Metal insert
without lid or with closed lid:	≤ 39.3 mm	Metal strip and adhesive strip at front
with open lid:	≤ 80.0 mm	Without any insert
with open lid:	≤ 77.3 mm	Adhesive strip at front

Filling the magazines

- First fill Leica IP C magazines 4 to 6 with cassettes and insert them.
- Then fill Leica IP C magazines 1 to 3 with cassettes and insert them (see 1-6 in (→ "Fig. 28-1")).

4 Instrument Setup

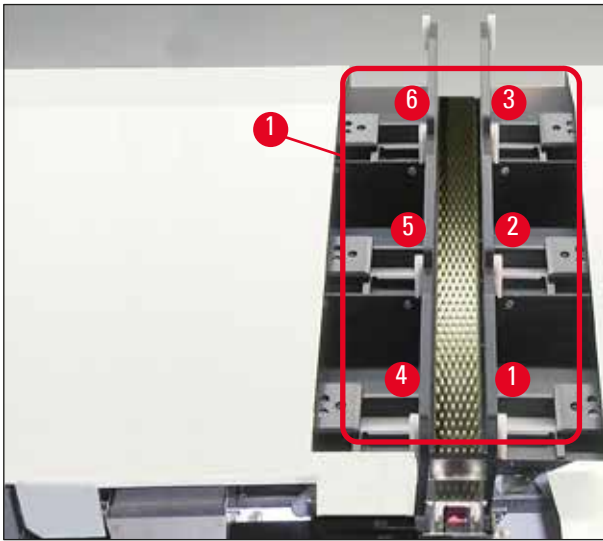

Fig. 28

- When filling a magazine with cassettes, ensure that the cassette side to be imprinted is to the left after insertion.
 - If cassettes are individually loaded, be certain that they are aligned properly and that there are no gaps between the cassettes.
 - To achieve this, use your finger to carefully lift the cassettes slightly from below, then release them.
- ✓ The cassettes should then lie in the magazine properly (→ "Fig. 29").

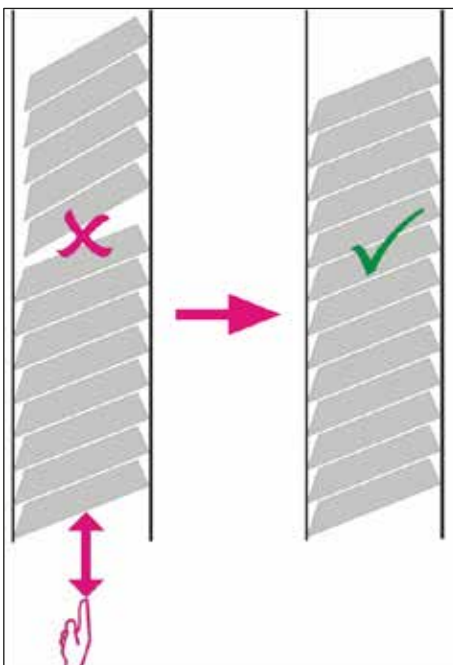

Fig. 29

**Note**

When filling the magazines ensure no gaps are present between the cassettes.

- If taped cassettes are used, make sure the newly inserted stack aligns perfectly with the previously loaded cassettes (→ "Fig. 29").

**Note**

IMPORTANT! Always pull off the adhesive strip (→ "Fig. 30-1") from top to bottom, so that no gaps can arise between the cassettes.

Depending on the type of cassettes, each magazine holds up to 80 cassettes. If cassette sizes other than those specified in the table on (→ p. 37 – Filling and inserting the magazines) are to be used, use trial and error to find out which insert is required in the magazine.

**Caution**

Important!

Only the cassette sizes listed in the table on (→ p. 37 – Filling and inserting the magazines) have been tested with the Leica IP C.

Leica does not guarantee that cassette types other than those tested can be processed in the instrument.

1. Insert a filled magazine (→ "Fig. 30-2") into the printer as shown and insert it into the holder at the slot.
2. Tilt the magazine backwards as far as it will go, then firmly push the magazine downwards. Guide rail (→ "Fig. 30-3") must lock into holder (→ "Fig. 30-4").
3. Keep following this procedure until the printer is completely filled with magazines; observe the correct sequence while doing so.

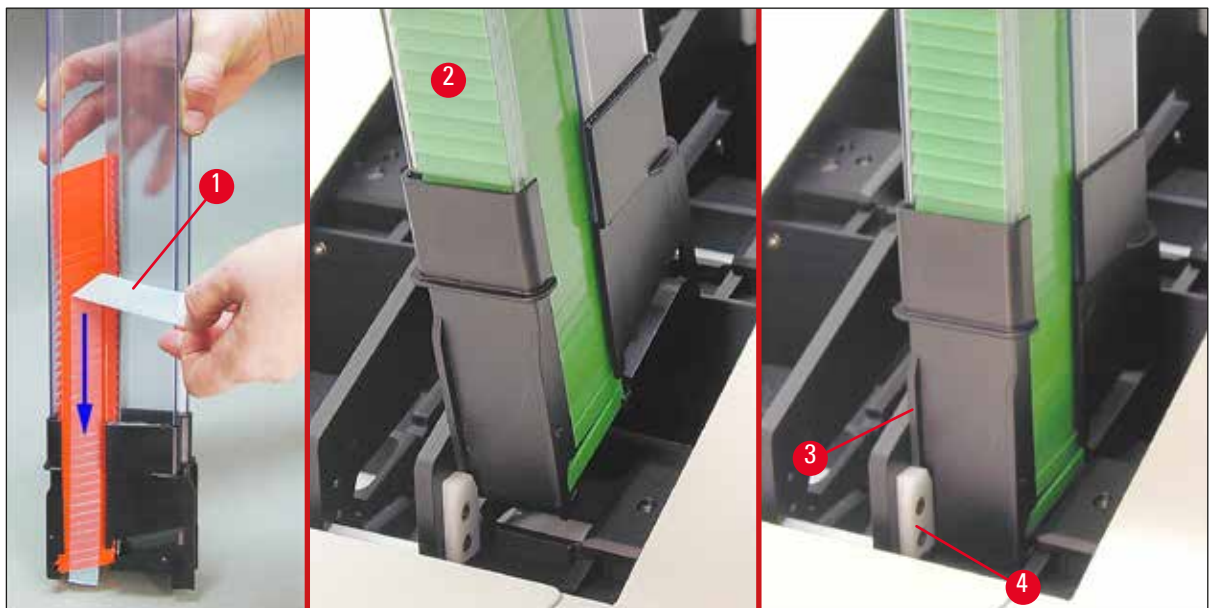

Fig. 30

4.8 Electrical connection

**Warning**

The instrument must be connected to a grounded mains socket.

Of the set of power cords supplied, be sure to use only the one that is appropriate for the local power supply (plug must fit on-site wall outlet).

Connecting to mains

① The electrical connections are located at the back panel of the instrument (→ "Fig. 31").

1. Make sure the printer is switched **OFF**, mains switch (→ "Fig. 31-3") in position "**0**" = **OFF**.
2. Insert the correct power cord into the mains input socket (→ "Fig. 31-4").
3. Switch on mains switch (switch to position "**I**" = **ON**).



Fig. 31

**Note**

Once switched on for the first time, the mains switch (→ "Fig. 31-3") should always remain in position "**I**" = **ON**.

Setting up the data connection

① To use the printer, a serial data cable (→ "Fig. 32") is required (→ p. 29 – 4.3 Standard delivery).

1. Connect the cable to printer port (→ "Fig. 31-1").
2. Connect the cable to one of the serial ports (**COM 1**, **COM 2**) of the computer containing the control software.



Fig. 32

Connecting a remote alarm device

- ① If required, connect the external alarm system (optional) to jack (→ "Fig. 32-2").
 1. The remote alarm device is connected to the printer via a 3.5 mm-diameter jack connector.
 2. For details about the remote alarm see (→ p. 57 – 5.3 Alarm functions).



Warning

Any device that is connected to any one of the instrument interfaces must satisfy the requirements for SELV circuits.

4.9 Exchanging the transport cartridge for an ink cartridge

In the factory condition, the printer is supplied with a transport cartridge (→ "Fig. 33-3") inserted. To be able to print, the transport cartridge must be exchanged for an ink cartridge (→ p. 29 – 4.3 Standard delivery). To do so, proceed as follows:

1. Open the cover plate (→ "Fig. 33-2") on the left side of the instrument (pressing its top left corner).
2. Loosen the red cap (→ "Fig. 33-4") of the transport cartridge (→ "Fig. 33-3") by one turn, then switch on the printer using the main switch on the rear side (→ "Fig. 31-3") and wait for it to initialize.

4 Instrument Setup

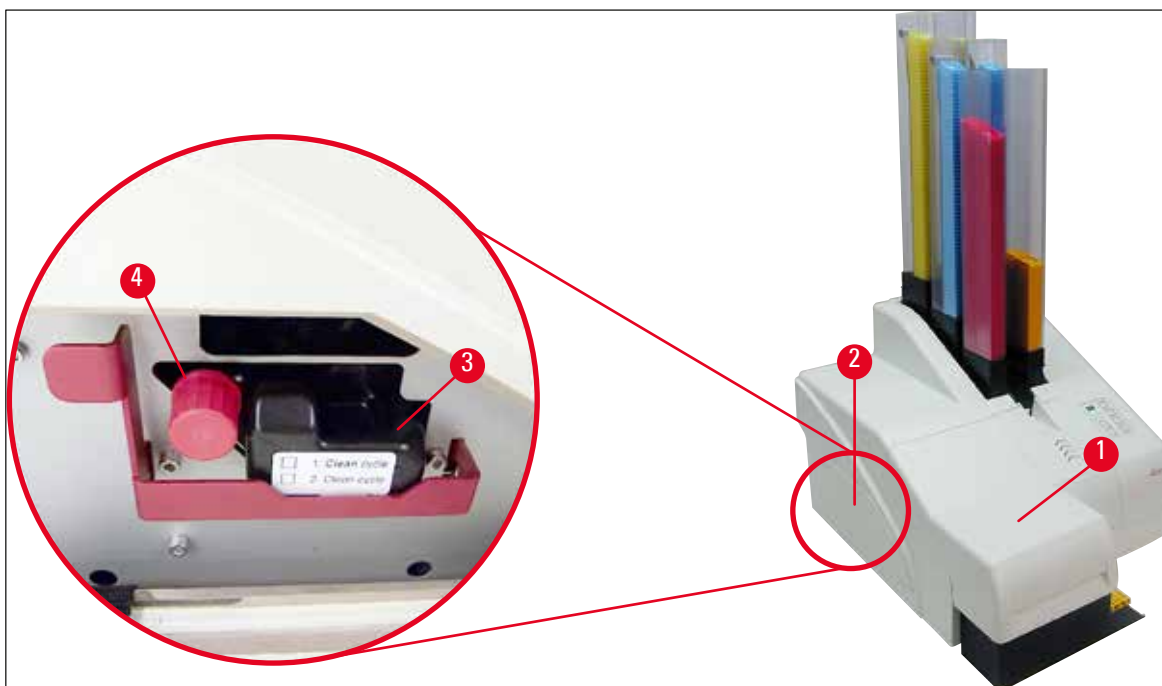

Fig. 33



3. Open the hood (→ "Fig. 33-1"), then press the **CLEAN** and **LOADED** keys control panel (→ "Fig. 37-1") simultaneously.

4. The print head (→ "Fig. 34-2") moves upward to a position approx. 1 cm away from the sealing lip (→ "Fig. 34").
5. Raise the lever (→ "Fig. 34-1"), then remove the black transport plate (→ "Fig. 34-3") and insert the replacement plate (→ "Fig. 35-1") required for printing. Make sure that the engraved arrow (→ "Fig. 35-3") is upward and pointing in the direction of the print head.

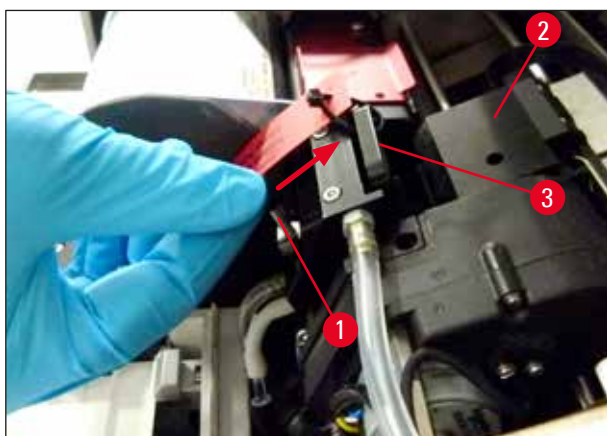

Fig. 34

**Warning**

Do not reinstall a used transport plate (→ "Fig. 35-2"), as it will no longer completely seal the print head.
To prevent damage to the print head, always use the red replacement plate (→ "Fig. 35-1") when printing.

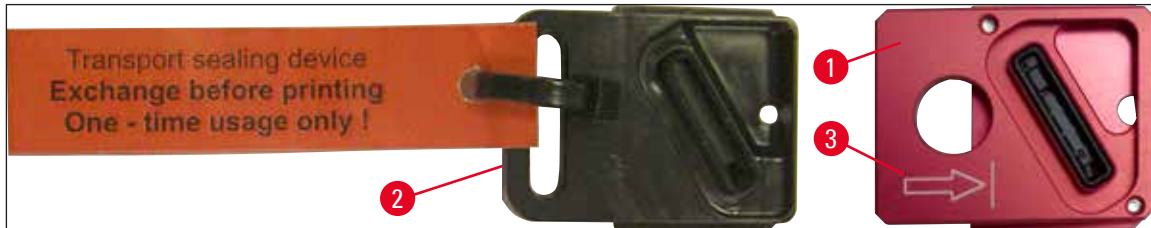

Fig. 35

6. Push the small lever (→ "Fig. 36-1") back down into its original position.

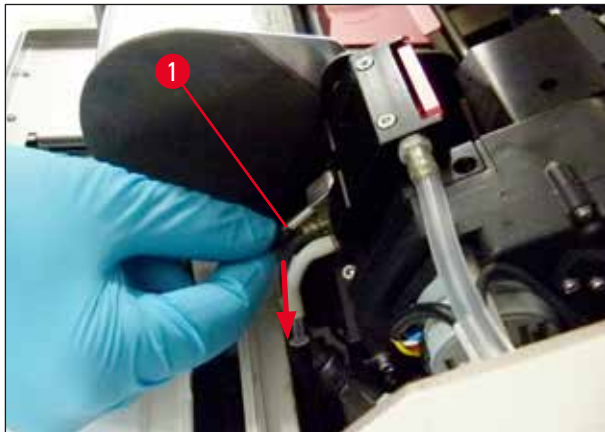

Fig. 36

7. Press any key of the control panel (→ "Fig. 37-1") to reposition the print head and make the printer ready to operate.

**Caution**

If no key is pressed, the print head will close automatically 150 seconds after opening to prevent it from drying out. An acoustic signal (5 beeps) will sound after 120 seconds, after which the final 30 seconds will be counted down on the display (→ "Fig. 37-2").

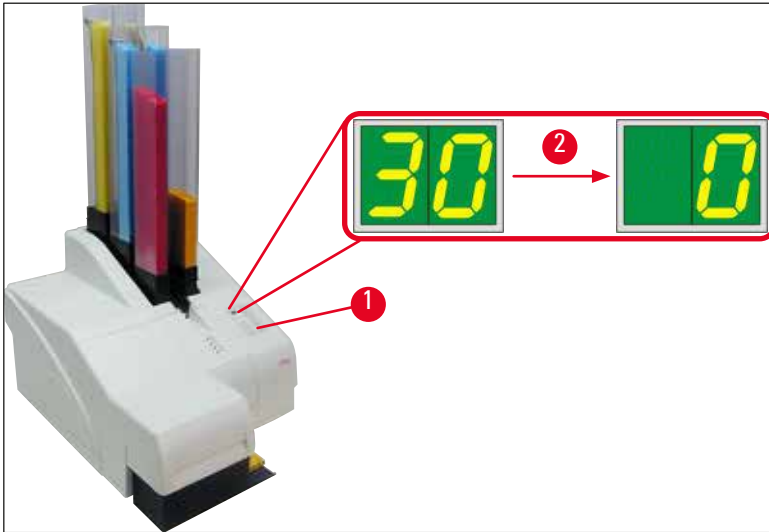

Fig. 37

8. Press the red retaining bracket (→ "Fig. 38-1") down and hold it in this position, so that the transport cartridge can be removed.
9. Pull the transport cartridge (→ "Fig. 38-4") approx. 30 mm out of the instrument until the **INK EMPTY LED** lights up (→ "Fig. 38-2").
10. Retighten the red cap (→ "Fig. 38-3") and then remove the cartridge completely (→ "Fig. 38-5").
11. Release the red retaining bracket.

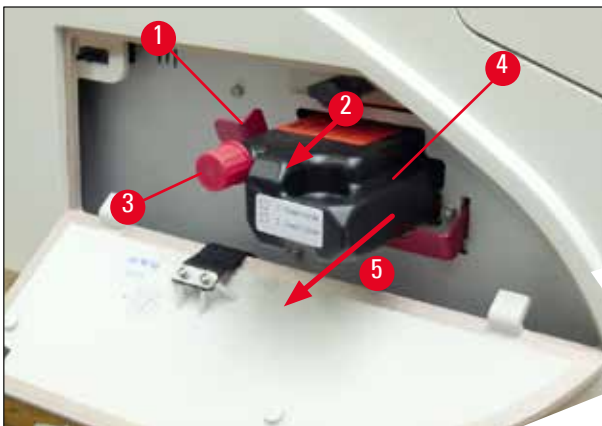
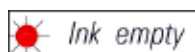

Fig. 38

- ① The activation of a sensor in the cartridge slot blocks all functions so that no air is sucked into the ink system.



12. The **INK EMPTY** indicator **LED** lights up and remains on.

- ✓ Store the removed transport cartridge in a sealed container. The cartridge is full and can be used twice more to clean the print head. The expiration date can be found on the red label.

Inserting the ink cartridge



Note

- In this instruction, an example of how to insert the ink cartridge is shown using the Leica IP S printer. This also applies to the Leica IP C printer.
- Follow the information on the flag attached to the ink cartridge.



Warning

The ink cartridge has to be replaced after 3.5 months at the latest or after 60,000 prints. Any use beyond this will result in a deterioration of the ink and print quality. Prolonged use of the ink cartridge is contrary to the intended use of the device. Damage to the device or any loss of samples is not covered by the Leica warranty. On the white surface on the front side of the ink cartridge, note the date when the ink cartridge was installed.

1. Take a new ink cartridge from the carton and remove the plastic packaging.
2. Carefully shake the ink cartridge 2 to 3 times.
3. Pull the red retaining bracket (→ "Fig. 39-1") forward and insert the new ink cartridge about halfway into the slot (→ "Fig. 39-2").
4. Open the red protective cap (→ "Fig. 39-3") one turn counterclockwise.



Fig. 39

- ✓ Then fully insert the ink cartridge into the slot.



Note

Puncturing the cartridge seal requires that some force be applied (→ "Fig. 40-1").



Fig. 40

Removing the red protective cap

1. Unscrew the red protective cap (→ "Fig. 39-3") all the way.
2. Remove the information flag and place the red protective cap in the recess provided on the ink cartridge (→ "Fig. 41-1").
3. Upon completion, make sure that the red retaining bracket is in the correct position (→ "Fig. 41-2") and close the cover plate (→ "Fig. 41-3") of the printer.

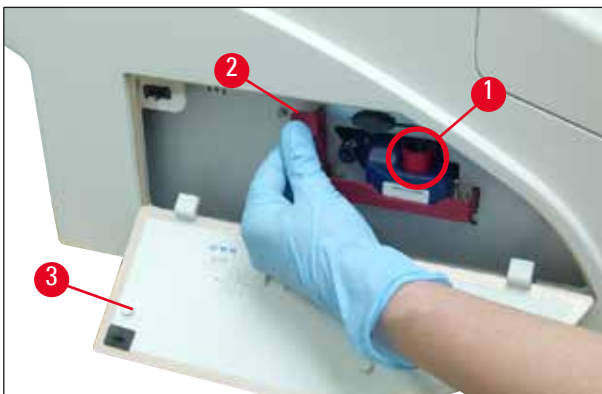

Fig. 41



Warning

Never press the **CLEAN** button while a new or used ink cartridge is in the instrument!
 Very important! Prior to each transport, the cap (→ "Fig. 39-3") must be screwed onto the nozzle to prevent the ink from spilling.

4. The sensor in the cartridge slot recognizes the presence of a new cartridge.
5. The **INK EMPTY** indicator **LED** goes out and **88** appears on the display.



At this point, the instrument has to be "told" which type of cartridge has been inserted.

There are three options:

1. New ink cartridge:

- » Press **LOADED**; the printer sets the ink level to "full".



2. Used ink cartridge:

- » Press **ERROR**; the printer resumes measuring at the ink level where it previously left off.



3. Used or new transport cartridge:



Caution

NEVER press **CLEAN** while an ink cartridge is in the instrument! The entire contents of the ink cartridge will spill into the printer.

- » Press the key **CLEAN**; the current ink level is stored.



Note

The fill level of the transport cartridge is not monitored. Each use should be noted on the cartridge. The cartridge can be used twice. The cycle time when inserting a transport cartridge is 3.5 minutes and is thus considerably longer than that of an ink cartridge.

- After one of the three buttons has been pressed, the ink exchange software routine starts; air is evacuated from the hoses and the system is refilled with liquid.
 - ✓ When the procedure has been completed, **88** disappears from the display.

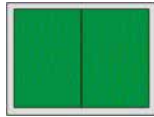

Running a test print

- ① Run a test print to verify whether the print head works correctly.
- 1. For that purpose, fill some cassettes into a magazine and insert the magazine into magazine position 1.
- 2. Press and hold the **CLEAN** button until "00" is displayed, then release the button. A cassette is imprinted with a stored test image.



- ✓ If the print result is not satisfactory, this step can be repeated several times.

4.10 Installing the printer driver



Note

For information about installing the printer driver, please refer to the software Installation Instructions supplied together with this Instructions for Use. If you have problems installing the new printer driver, please contact your local Leica service department.

5. Operation

5.1 Control panel functions

The control panel

- consists of a membrane keyboard with six pressure-sensitive keys (four of them with an **LED**, two **LED** displays and a two-figure sevensegment display (→ "Fig. 42-1")),
- controls the printer functions and the print jobs that are defined via the control software,
- indicates current printer status and processes in progress,
- indicates errors and/or error messages,
- controls the (optional) automated unload station.

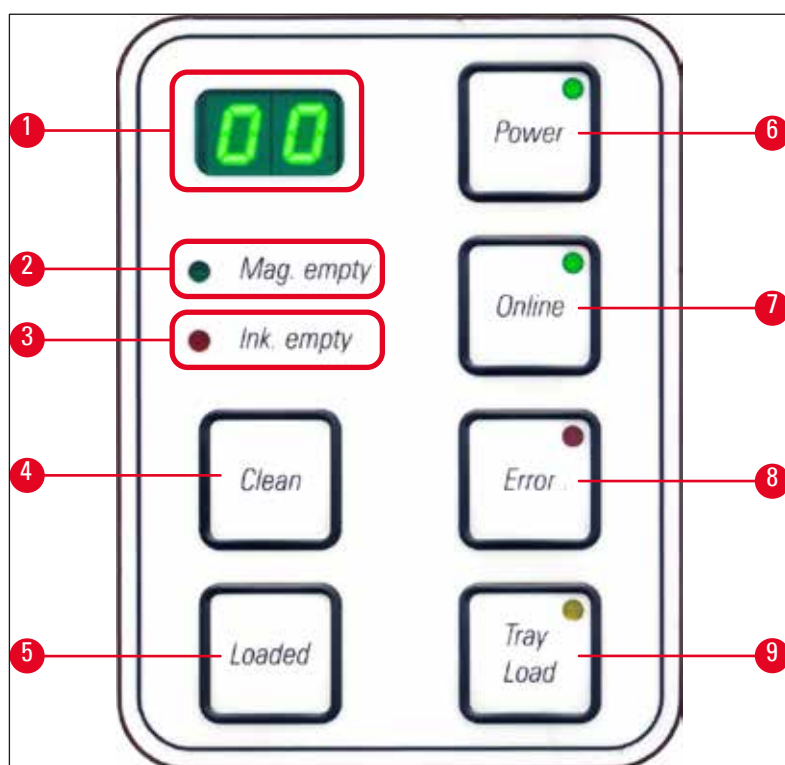

Fig. 42

MAG. EMPTY LED (→ "Fig. 42-2")

LED off:

- Magazines are full or up to that point no further cassette has been requested from a magazine that has just been emptied.

LED flashing:

- Flashing **LED** and number on display indicate which magazine is empty.

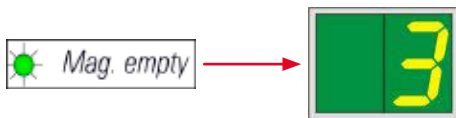

- If several magazines are emptied at the same time, the corresponding magazine numbers are indicated in a recurring sequence.
- After refilling the magazine, **LOADED** (→ "Fig. 42-5") must be pressed to inform the printer that the magazine has been refilled.
- The printer will resume the interrupted print job where previously left off.

INK EMPTY LED (→ "Fig. 42-3")

LED off:

Sufficient quantity of ink remaining – printing is possible without any restrictions.

LED flashing:

Ink cartridge will be empty shortly – keep replacement ink cartridge handy.



LED on:

Ink cartridge empty, no further printing possible.

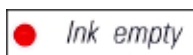

POWER (→ "Fig. 42-6")

Switching from POWER ON to STANDBY mode and back

LED illuminated – POWER ON mode

- Power is supplied to all printer systems.
- The flash power supply is continuously being recharged.
- The printer is ready to print immediately.

LED flashes – STANDBY mode

- All power consumers of the printer are switched off, with the exception of those related directly to the processor (power saving mode).
- The printer cleans a print head at regular intervals (e.g. 4 times a day). For that purpose it switches into **POWER ON** mode for a short period of time.

LED off:

- Printer disconnected from power supply.



Note

Printing is possible in **POWER ON** mode only.

To activate **POWER ON** with the printer being in **STANDBY** mode, press **POWER**. **POWER ON** will be activated via the PC interface.

If no print job is received within a certain period of time, the printer automatically switches over to **STANDBY** mode. After switching from **STANDBY** mode to **POWER ON** mode, there will be a reduced print throughput until all systems have reached their proper operating temperature.

LOADED (→ "Fig. 42-5")

To confirm a magazine exchange

Pressing **LOADED** briefly:

- Informs the printer that an empty magazine has been refilled and put back into place. (Or that a magazine has been removed and replaced by another one containing cassettes of a different color).

Pressing and holding **LOADED** for approx. 10 sec. in offline mode:

- Informs the printer that a cartridge has been exchanged (→ p. 41 – 4.9 Exchanging the transport cartridge for an ink cartridge).

ONLINE (→ "Fig. 42-7")

Interrupting a print job in progress.

LED on:

Printer is ready and waiting for a new print job.

LED flashing:

- A data transmission is in progress or a print job is being carried out.
- Pressing **ONLINE** while a print job is in progress interrupts printing. The current print job, however, is completed. The **ONLINE LED** goes out. At that point the printer can be accessed (e.g. to remove a half-empty magazine and refill)
- To resume the previously interrupted print job, press **ONLINE** again. The **ONLINE LED** goes back on or – if there are still print jobs that have not been completed – the **LED** starts flashing.

LED off:

- Printer is offline. No print jobs will be carried out until the printer is made ready (**LED on**).

ERROR (→ "Fig. 42-8")

Acknowledging an error code being displayed.

LED flashing:

- An error has occurred. The corresponding error message is being displayed.



- If **ERROR** is pressed after having eliminated the source of an error and after all obstacles in the processing areas have been removed, the printer resumes normal operation and the error indication disappears.
- If several errors occur simultaneously, the highest priority error code is displayed first. After that error has been acknowledged by pressing **ERROR**, the second highest priority error code is displayed and so on.

CLEAN (→ "Fig. 42-4")

Cleaning the print head and carrying out a print test

Pressing CLEAN briefly

While a print job is in progress:

- The print job is interrupted. **00** will appear on the display for about 2 s.
- A print head clean is carried out and subsequently the print job is resumed.

If no print job is in progress:

- The print head is cleaned immediately after **00** has been displayed.



Note

Pressing the **CLEAN** button briefly and then releasing it starts a print head clean (indicated by **00** being displayed). The total duration of the cleaning procedure can be extended to 10 seconds, if **CLEAN** is pressed once more as soon as **00** is displayed. Hold **CLEAN** for as long you wish to continue cleaning (max. duration = 10 sec).

Pressing CLEAN for a longer period of time (minimum 3 seconds)

While a print job is in progress:

- The print job is interrupted. Printer switches to offline mode. **00** will appear in the display for about 2 s.
- A print head clean is performed and subsequently a test print is carried out on the cassette currently being processed. The printer then remains in offline mode to enable the user to verify the print quality before resuming the current print job.
- If necessary, an additional clean can be performed.
- To resume printing, press **ONLINE** to return to online mode.
- The print job is resumed where previously left off.



If no print job is in progress:

- The printer switches to offline mode.
- All steps are performed as described above.



Note

When operating continuously, the printer pauses regularly for intermediate print head cleans. Printing is interrupted for approximately 10 seconds, after which time the instrument automatically resumes operation.

TRAY LOAD (→ "Fig. 42-9")



Note

If your printer is not equipped with an automated unload station, no function is assigned to this button!

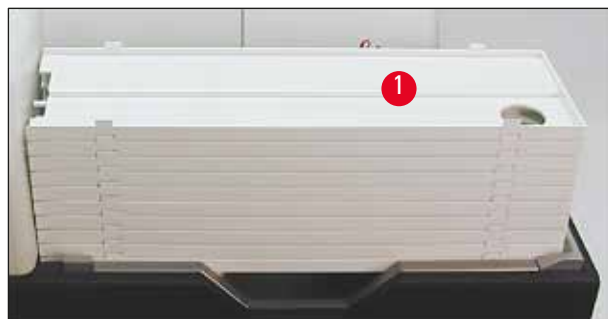

Fig. 43

5 Operation

Function:

- The imprinted cassettes are pushed out of the printer and onto the uppermost tray.
- At the right end of the tray there is a sensor (→ "Fig. 44-1"), which triggers a signal when covered. The tray stack is then moved upwards by one tray.
- Once all trays are full the instrument emits an acoustic signal (beep), the **LED** in the **TRAY LOAD** button starts blinking, the stack of trays can be removed.

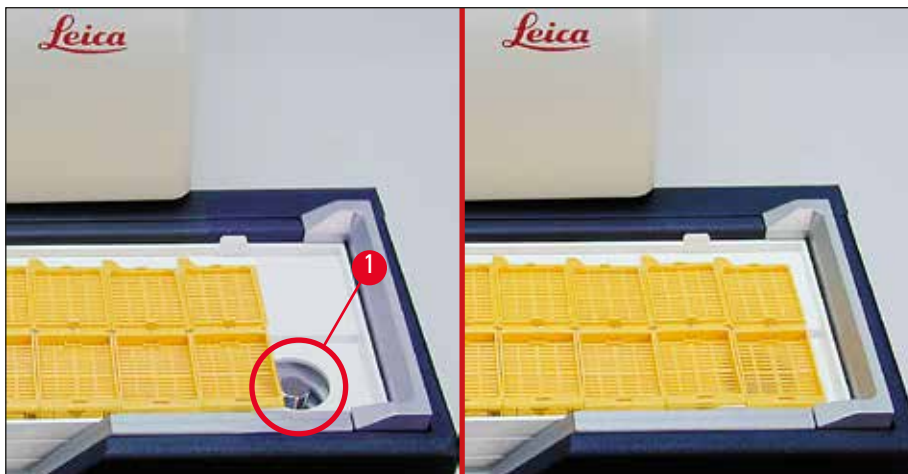

Fig. 44

Controls the movement of the lifting table of the automated unload station (optional)

1. Place a stack of trays (→ "Fig. 43-1") onto the lifting table of the unload station (→ "Fig. 43").
2. Any number of trays between 1 and 10 can be inserted, as the printer counts the trays when they are inserted.
3. Once the lifting table has reached its upper limit position, the **LED** (→ "Fig. 42-9") in the button starts blinking.
4. Press and hold **TRAY LOAD** longer than 1 sec.
5. The tray stack moves completely into the unload station, the **LED** in the button goes off, the printer switches to **ONLINE** mode.
6. Pending print jobs will be carried out.
7. When the stack of trays has moved completely or partly into the unload station:
8. Press **TRAY LOAD** briefly:
9. The stack of trays moves up by one tray.

If **TRAY LOAD** is pressed and held longer than one second:

- » The stack of trays moves completely out of the unload station, the **LED** in the button starts flashing. Any print job in progress is interrupted.



Note

Every time the printer is switched on, the stack of trays automatically moves one tray up, to ensure that the new print job is started with an empty tray.



Warning

Be careful about getting near the sensor (→ "Fig. 44-1"). Any object getting closer than 2 mm to the sensor will trigger a lifting movement.

5.2 Display indications

Display indication



Display

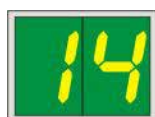
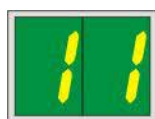

Magazine empty (in combination with MAG. EMPTY LED)

- | | |
|--------------------------|--------------------------|
| 1 - Magazine No. 1 empty | 4 - Magazine No. 4 empty |
| 2 - Magazine No. 2 empty | 5 - Magazine No. 5 empty |
| 3 - Magazine No. 3 empty | 6 - Magazine No. 6 empty |

If **MANUAL FEED** has been selected in the printer driver settings, **0** will appear in the display after the print job has been sent. The printer is waiting for an individual specimen slide to be placed in the feeding chute for printing.

Status messages

00 Ink print head cleaning in progress.

11 Temperature in the flash power supply is too high.

Printer is too hot and initiates a short cool-down period.

The print job will be resumed automatically after a short period of time. To prevent frequent job interruptions due to heat build-up, make sure the ventilation grids of the printer are unobstructed and keep the printer away from other heat sources.

Consider operating the printer in an air-conditioned room. If the temperature does not drop to a value within the allowed range within 10 minutes, **55** is displayed. Switch the instrument off and let it cool; check ambient temperature.

13 Flash bulb has reached its maximum life.

The flash bulb has reached the end of its specified service life and must be replaced.

If this message is ignored, the resistance of subsequent printouts can be affected.

14 Prompt requesting maintenance.

If this message is displayed, the instrument will be due for maintenance within the next few weeks. Confirm the prompt by pressing **ERROR**.

After about 8 weeks the message will be displayed again and will not disappear from the screen when pressing **ERROR**.

Display



Status messages

15 **Mandatory cleaning of the print head.**

This screen prompt appears every 7 days, requesting the user to manually clean the print head.

- Warning threshold 1: Print jobs are not sent to the printer while error 15 is not acknowledged. This error can be acknowledged without cleaning the print head, to continue printing. But it is highly recommend to perform the print head cleaning immediately.
- Warning threshold 2: After the user has acknowledged error 15 without cleaning the print head the day before to continue printing, the error reappears on day 8 and can not be acknowledged until the user has manually cleaned the print head. Printing will only be possible again after the print head has been cleaned.

87 **After the last cartridge change, CLEAN**

has been pressed to indicate to the printer that a transport cartridge has been inserted. The printer has received a print job but is unable to print because the cartridge contains cleaning fluid instead of ink.

Remedy:

Cancel the print job. Switch the printer off and back on and change the cartridge. Then press **LOADED** or **ERROR** and wait for 2 minutes.

**Caution**

Never press **LOADED** after reinserting an ink cartridge which has already been used. This could cause permanent damage to the printer.

81-86 **Warning: Problem with cassette ejection from a magazine!**

The display consists of two parts: The **8** is a warning that a magazine ejector is mechanically blocked. The second digit of the message (**1-6**) specifies the number of the affected magazine.

Error messages

All displayed numbers from **20** to **78** and **89** to **93**.

5.3 Alarm functions

The Leica IP C is equipped with two different alarm functions:

Instrument alarm

The printer has a beeper that emits acoustic signals indicating important instrument states and functions.

- Upon pressing a button: 1 short beeping sound
- Magazine empty/tray stack full: 2 short beeping sounds
- In case of error: 5 short beeping sounds
- When ending the head cleaning: 5 short beeping sounds

The beeper can be deactivated by means of the DIL switches at the back panel of the printer.

- » To deactivate the beeper, push the switch at the very bottom (→ "Fig. 45-1") to the right (→ "Fig. 45").



Fig. 45

Remote alarm

Additionally, an alarm can be installed outside the room in which the printer works.

- The remote alarm device is connected to the printer via a 3.5 mm-diameter jack connector that is inserted into socket (→ "Fig. 45-2").
- The remote alarm is triggered if no power is supplied to the printer or if the power switch at the back panel of the printer is switched off.



Warning

The remote alarm device connected to the instrument must be rated at less than 100 mA. A maximum voltage of 24 V DC must not be exceeded.

For details on how to connect a remote alarm device to the Leica IP C, please contact your local Leica sales office or the manufacturer directly.

5.4 Printer driver settings



Note

With the Leica IP C cassette printer you can print cassettes from any Windows application allowing the user to individually configure the printing parameters. The description below refers to Microsoft Wordpad, a program that is part of any Windows installation and therefore available on all PCs supported by the printer driver. The dialog boxes to be accessed in other programs may be named differently, but the driver parameters that need to be selected are named identically in all programs.

Configure the printer in the application that will be used for imprinting the cassettes.

1. Click on **File > Print** to open the **Print** dialog box.
2. From the list of available printers, select Leica IP C (the name of that printer was added when installing the printer driver (→ p. 48 – 4.10 [Installing the printer driver](#))) and confirm by pressing the corresponding button.
3. First, the page settings must be selected: Click on **File > Page Setup** to open the **Page Setup** dialog box (→ "Fig. 46").
4. In **Margins** (→ "Fig. 46-1"), set all margins to **0**; the print range will change as shown (→ "Fig. 46-5").
5. In **Orientation**, select **Portrait** (→ "Fig. 46-2").
6. Once the printer has been set up as described above, a cassette format will automatically be shown in the **Size** (→ "Fig. 46-3") input field in the **Paper** dialog box. You can choose between two cassette formats "**cassette 35 °**" and "**cassette 45 °**".
7. In the **Source** (→ "Fig. 46-4") input field you can select the magazine(s) which will supply the cassettes to be imprinted.
8. Deactivate **Print Page Numbers** (→ "Fig. 46-6").

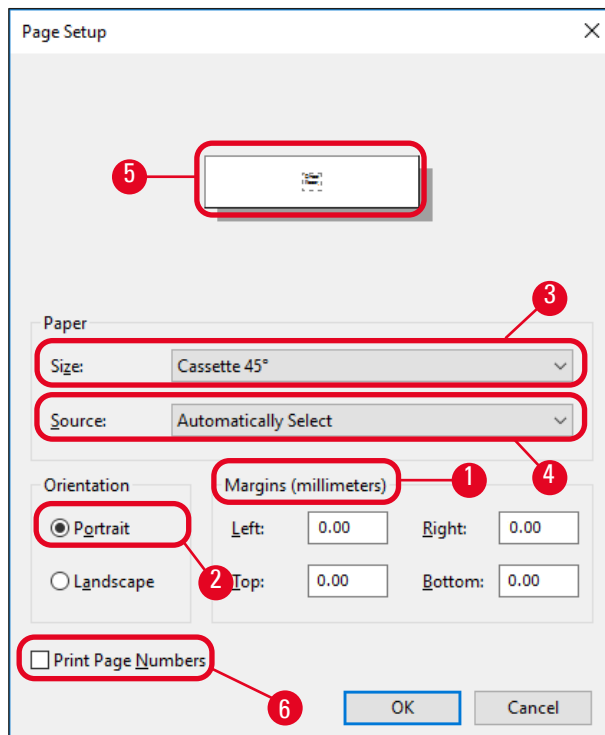

Fig. 46

**Warning**

The cassette type (angle 35 ° or 45 °) selected in **PAPER > SIZE** and the cassette type actually used must match. Otherwise, the print head can be damaged.

Selectable options in the Paper > Source dialog box

When clicking on the **Source** input field, an alphabetical list of all cassette supply options from all 6 magazines opens up.

- **Manual feed** (→ "Fig. 47-1") means that individual cassettes will be placed onto the chute (→ "Fig. 2-6") and imprinted. The printer will not start printing until the sensor (→ "Fig. 2-7") reacts (→ p. 55 – 5.2 Display indications).
- Further options are magazines 1 through 6. If a particular magazine has been selected as supply source, printing will stop once that magazine is empty.
- If a group of magazines is selected (such as **C (1|2|4|5|6)**), printing will continue until the last magazine of the group selected is empty, i.e. printing will not stop when just one magazine is empty.

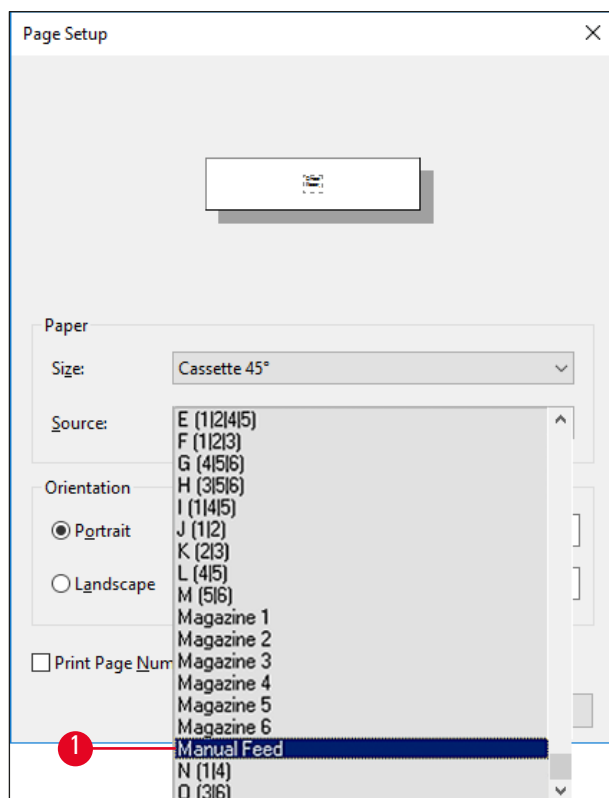

Fig. 47

**Note**

Working with magazine groups is useful for printing large jobs requiring more cassettes than fit into one magazine or when several magazines have been filled with cassettes of the same type (e.g. same color). The magazines will be processed in the indicated order.

Accessing the Advanced Options dialog box

1. To select advanced parameters, click **File > Print...** to access the **Print** dialog box.
2. Click on **Preferences...** to enter the **Printing Preferences** dialog box.
3. Click **Advanced...** to access the **Advanced Options** dialog box.

The Advanced Options dialog box (→ "Fig. 48")

Clicking onto the individual menu items opens up a pull-down menu to their right, where you can select the desired parameters.

Any menu items not described here are of no importance for the printer. Therefore, the standard settings of all menu items not described here should remain unchanged.

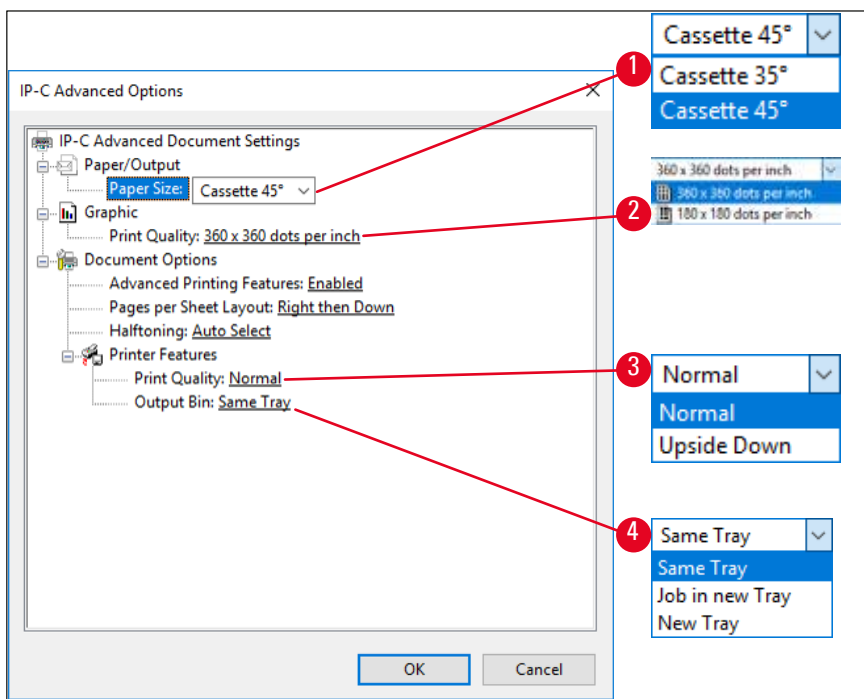

Fig. 48

Paper/Output > Paper Size menu (→ "Fig. 48-1")

- In the **Paper Size** menu you select the type of cassette, i.e. the size of the imprintable zone of the cassette. The cassette type selected in this menu should be identical to the one selected in **Page Setup** (→ "Fig. 46-3").

Graphic > Print Quality (→ "Fig. 48-2")

- The print head resolution can be switched between 360 and 180 dpi (→ "Fig. 48-2"). With cassette surfaces not appropriate for 360 dpi resolution, printing results will be poor when it is selected. For such cassettes, 180 dpi should be selected.

Printer Features > Print Quality menu (→ "Fig. 48-3")

You can select whether an imprint is to be applied onto a cassette normally (**NORMAL**) or are rotated 180 ° (**UPSIDE DOWN**).

Printer Features > Output Bin menu (→ "Fig. 48-4"): The **Output Bin** menu item is important above all for the multi-cassette unload station.

- **Same Tray:** cassettes are deposited onto a tray until the tray is full.
- **Job in new Tray:** each print job starts with a new tray.
- **New Tray:** Only for special applications – do not select this option under standard Windows programs.

**Note**

When using the manual unloading system, the values configured in the **Output Bin** menu item are not considered by the device.

6. Cleaning and Maintenance

6.1 Cleaning the instrument



Warning

- Prior to cleaning the instrument, always switch off power supply and unplug the power cord! When handling cleaning detergents, follow the instructions of the manufacturer and make sure all laboratory regulations in force in your country are complied with.
- To clean the exterior surfaces, use a mild and ph-neutral commercial household cleaner. You may not use: Alcohol, cleaning materials containing alcohol (glass cleaner!), abrasives or solvents containing acetone or xylene!
- No liquid may come into contact with the electrical connections or spill into the interior of the instrument!
- The Leica IP C needs to be thoroughly vacuum cleaned once a week.

Cassette guiding mechanisms

Cleaning of the following IP modules marked by an arrow is of particular importance:

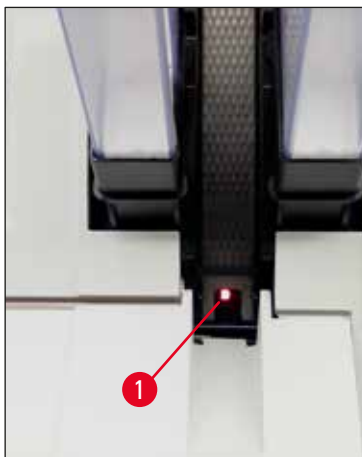

Fig. 49

- Loading station (→ "Fig. 49")
The ejection unit of the magazines, magazine holders and chute. Always ensure that the sensor (→ "Fig. 49-1") at the end of the chute is clean.

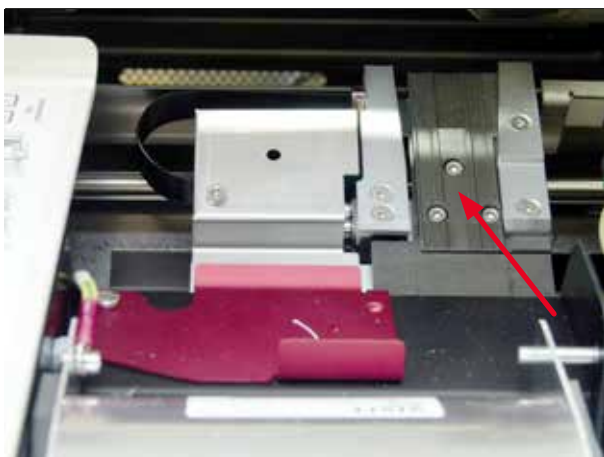

Fig. 50

- Transport station (→ "Fig. 50")
Remove dust and debris from the cassette clamp.



Fig. 51

- Drying station chute (→ "Fig. 52")
The swivelling flap must be open (→ "Fig. 51-1").
The chute must be clean (→ "Fig. 52").



Caution

Sensitive electronics components are located in this area.
Use no liquid in this area!

- Close the flap after cleaning and before using the instrument (→ "Fig. 50").



Fig. 52

Outer surfaces

- Clean the outer surfaces (including those of the automated cassette unload station) with a mild detergent and subsequently dry with a slightly moistened cloth.
- Do not use any solvents for cleaning the outer surfaces and the lid!

Automated unload station

- Remove the unload trays; with a brush, remove dust and debris from guides and ejector.
- Clean the sensor (→ "Fig. 53-1") using a vacuum cleaner.



Fig. 53

- The trays themselves can be cleaned with a household cleaner.
- Do not use any solvents to clean the trays!
- Prior to reinserting them into the instrument, the trays must be completely dry.

6.2 Cleaning the print head

Preparing the printer:

The print head must be cleaned manually once a week or if the message 15 is displayed.



1. Open the printer hood (→ "Fig. 33-1") and then press the **CLEAN** and **LOADED** keys simultaneously.



2. The print head (→ "Fig. 54-1") moves upward to a position approx. 1 cm away from the sealing lip (→ "Fig. 54").

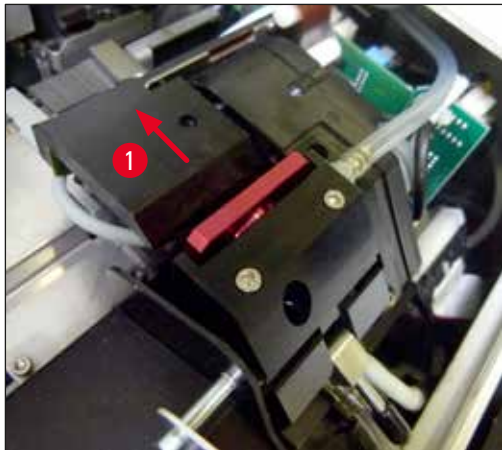

Fig. 54

3. Push the lever (→ "Fig. 55-1") upwards, then remove the red replacement plate (→ "Fig. 55-2") with the sealing lip.

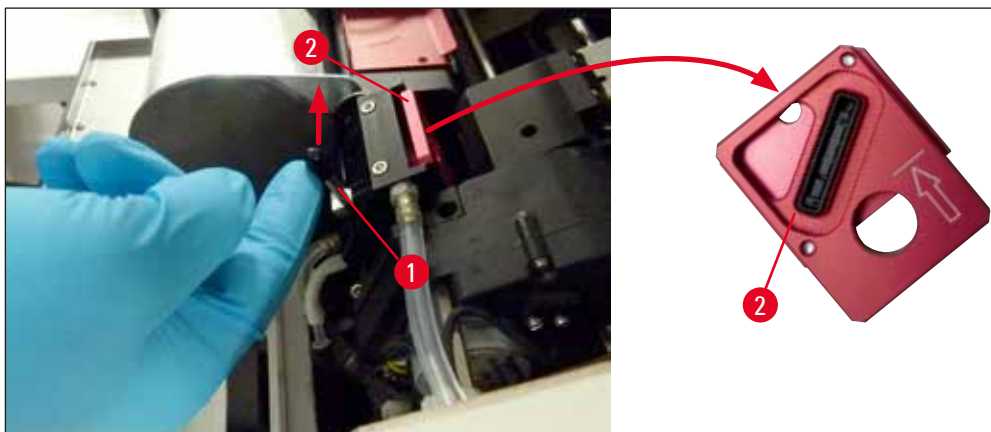

Fig. 55

4. Moisten one of the foam swabs supplied with the instrument (→ "Fig. 56-1") with some alcohol. Be sure not to use too much alcohol – no alcohol may drip into the instrument.



Warning

Never use acetone or xylene! Only use 95 % or 100 % (recommended) alcohol for cleaning purposes.

5. Carefully insert the swab into the gap under the print head raising it with slight pressure (onto the print head) (→ "Fig. 56"). Move the swab from the top left to the bottom right (along the sealing lip). Turn the swab slightly after each movement to ensure that in each case, a clean area of the swab is used for the next movement. Repeat this procedure until all dried ink residues have been removed.

6 Cleaning and Maintenance



Warning

Never rotate the swab or apply too much pressure – this can damage the nozzle plate of the print head.



Fig. 56

6. Also clean the replacement plate (→ "Fig. 57-1") and sealing lip with (clean) alcohol. The sealing lip (→ "Fig. 57-2") must be completely free of ink residue.
7. Check the sealing lip for damage. Replace the replacement plate if the sealing lip is damaged.

Replacement plate

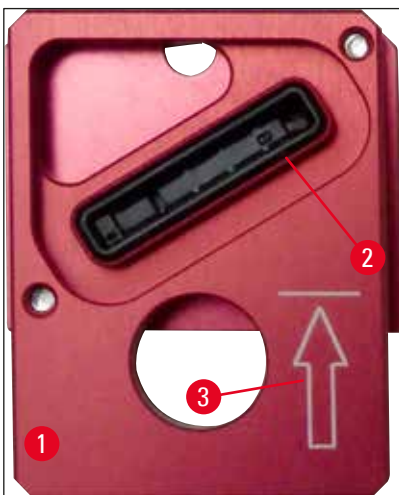

Fig. 57

8. Reinsert the replacement plate (→ "Fig. 57-1").



Note

When inserting the replacement plate, make sure that the engraved arrow (→ "Fig. 57-3") is upwards and pointing in the direction of the print head.

9. Push the small lever (→ "Fig. 58-1") back down to secure the replacement plate.



Fig. 58

**Caution**

The replacement plate must be completely dry.

10. When the cleaning process is finished, press any key of the control panel to confirm.

11. The print head moves back to the rest position; the message **15** disappears from the display.



✓ The printer is once again ready for printing.

**Warning**

- If no button is pressed to acknowledge the end of the cleaning procedure, the printer automatically closes the print head after 2.5 min to prevent it from drying out. A signal sounds 30 s before it automatically closes and a countdown appears on the display. In order to avoid damage to the print head, avoid inserting the replacement plate at this time; instead wait until the print head closes.
- However, the message **15** remains on the display, as the instrument assumes that the cleaning has not been carried out.
- Open the print head again as described, insert the replacement plate correctly and press any button on the control panel to finish the cleaning process.

6.3 Exchanging the cartridge



Warning

The ink cartridge has to be replaced after 3.5 months at the latest or after 60,000 prints. Any use beyond this will result in a deterioration of the ink and print quality. Prolonged use of the ink cartridge is contrary to the intended use of the device. Damage to the device or any loss of samples is not covered by the Leica warranty. On the white surface on the front side of the ink cartridge, note the date when the ink cartridge was installed.

6.3.1 Removing the used ink cartridge

1. Open the cover plate (→ "Fig. 33-2") on the left side of the instrument by pressing its top left corner (→ "Fig. 33").
2. Close the red cap (→ "Fig. 39-3") and loosen it again with one full turn.
3. Press the red retaining bracket (→ "Fig. 59-1") down and pull the ink cartridge out (→ "Fig. 59-2") approx. 30 mm until the **INK EMPTY LED** (→ "Fig. 59-3") lights up.
4. Retighten the red cap and completely remove the cartridge from the printer.
5. Then remove the ink cartridge and store the ink cartridge in a horizontal position in a sealed container.
6. Dispose the used ink cartridge in accordance with the regulations of your laboratory and your legislative.

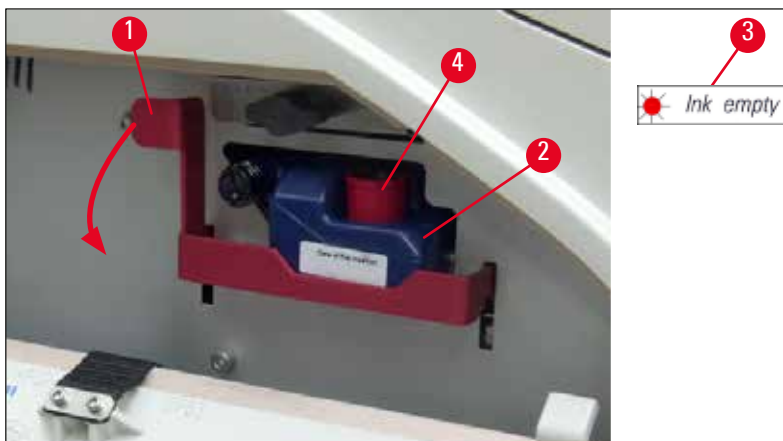

Fig. 59

6.3.2 Inserting the new ink cartridge

1. Take a new ink cartridge from the carton and remove the plastic packaging.
2. Carefully shake the ink cartridge 2 to 3 times.
3. Pull the red retaining bracket forward and insert a new ink cartridge about halfway into the slot.
4. Follow the information on the flag attached to the ink cartridge.
5. Open the red protective cap (→ "Fig. 39-3") one turn counterclockwise.
6. Fully insert the ink cartridge into the slot.

6.3.3 Removing the protective cap

1. Unscrew the red protective cap all the way, remove the information flag and place the red protective cap in the recess provided on the ink cartridge (→ "Fig. 59-4").
2. Upon completion, make sure that the red retaining bracket is in the correct position (→ "Fig. 41-1") and close the cover plate. **88** is displayed on the control panel.



Note

Never press the **CLEAN** button while a new or used ink cartridge is in the instrument!

3. On the control panel press **LOADED** (→ "Fig. 42-5").
4. Insert the new replacement plate (part of the ink cartridge kit).

Information on how to remove or insert the replacement plate and how to manually clean the print head: (→ p. 69 – 6.5 Storing the instrument) and (→ p. 64 – 6.2 Cleaning the print head).

6.4 General maintenance



Warning

Only authorized and qualified Leica service personnel may repair the instrument and access the instrument's internal components.

To ensure smooth operation of the instrument over many years we do recommend the following:

- Clean the instrument thoroughly on a daily basis.
- Regularly remove dust from the ventilation slots on the back of the instrument using a brush or a small vacuum cleaner.
- Have the instrument inspected once per year by a qualified service engineer authorized by Leica.
- At the end of the warranty period, enter into a service contract. For more information, please contact your local Leica technical service center.

6.5 Storing the instrument

General rules for storing the instrument:

Period of storage	Storing method and required measures
Up to 24 h	Instrument can be disconnected from mains, ink cartridge needs to be closed with red cap (→ "Fig. 60-2") in case of transport but cartridge can remain inside the printer. No additional measures are required.
24 h to 3.5 months	The instrument must remain connected to the power supply with the power on and the ink cartridge inserted. The ink cartridge can remain in the printer up to its expiration date. Weekly cleaning is required. The printer will regularly circulate the ink around the print head to stop the print head drying out.
3.5 to 6 months	Ink cartridge needs to be replaced with transport cartridge. Instrument needs to be disconnected from mains.

**Note**

- You must ensure that the ink cartridge is replaced according to its expiration date.

**Warning**

A printer may be stored for a maximum of six months after following the procedure described below. Storing the printer for longer periods may result in damage to the print head.

For transport or when the printer is to be disconnected from the power for long periods (from more than 24 h up to six months), a transport cartridge has to be inserted. To do so, proceed as follows:

- (→ p. 68 – 6.3.1 Removing the used ink cartridge): Follow steps 1 to 5.

**Note**

The ink cartridge cannot be used in another printer, because the ink level information is stored in the printer itself.

- Take the (new) transport cartridge (→ "Fig. 60-1") out of the delivery carton.
- Remove the protective foil and insert the cartridge until it is about half way into the cartridge slot (→ "Fig. 60").
- Loosen the red protective cap (→ "Fig. 60-2") by one turn.
- Push in the transport cartridge all the way and check that the red retaining bracket (→ "Fig. 59-1") is positioned correctly.
- Unscrew the red protective cap (→ "Fig. 60-2") and place it in the recess provided for the cap in the cartridge (→ "Fig. 60-3").
- Mark one of the two boxes on the front of the cartridge to ensure that the transport cartridge is used only twice.
- Close the cover plate on the left side of the printer.

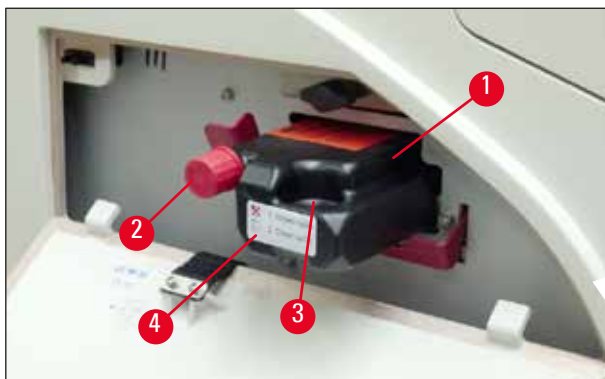

Fig. 60

9. The **INK EMPTY LED** goes out, and **88** appears in the display.



10. Press **CLEAN** to clean the print head (duration: approx. 3.5 min) - **00** appears in the display. The display will go out when the cleaning process is complete.



Note

The cleaning process with solvent takes approx. 3.5 minutes.

11. Open the hood of the printer (→ "Fig. 33-1"), then press the **CLEAN** and **LOADED** buttons at the same time.



12. Pressing those buttons moves the print head (→ "Fig. 61-1") up and away from the replacement plate.

13. Push the lever (→ "Fig. 61-2") up to allow removal of the replacement plate.

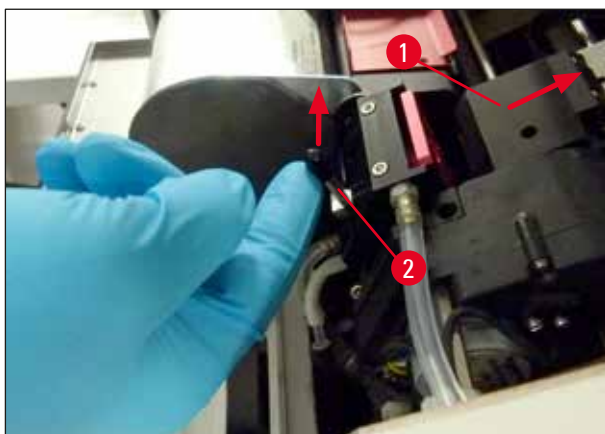

Fig. 61

6 Cleaning and Maintenance

14. Remove the red replacement plate (→ "Fig. 62-1").
15. Clean it using alcohol (95 %-100 %).

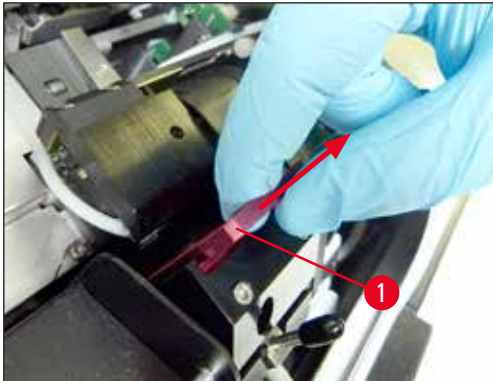

Fig. 62

16. Clean the print head with alcohol (95 %-100 % recommended) and the provided cleaning swabs (→ "Fig. 63-1"). This involves pushing the swab underneath the print head, raising it with slight pressure (onto the print head) and moving from the top left to the bottom right (along the sealing lip). Turn the swab slightly after each upward movement.



Fig. 63



Note

Always use the cleaning swab for the print head once only. Never rotate the swab – as this can damage the nozzle plate of the print head.

17. Then push in the new black transport plate (→ "Fig. 64-1") as far as it will go.



Fig. 64

18. Push the small lever (→ "Fig. 65-1") back down to secure the transport plate.

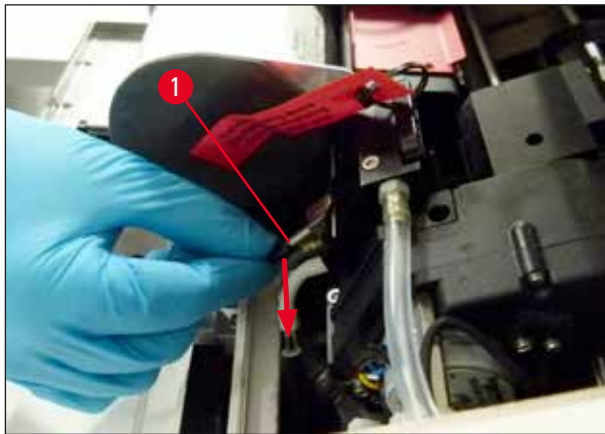

Fig. 65

19. Press any button to close the print head.

**Warning**

If pressing a button does not end the replacement of the exchange plate, the printer automatically closes the print head after 2.5 min. A signal sounds 30 s before it automatically closes and a countdown appears on the display. In order to avoid damage to the print head, avoid inserting the transport plate at this time; instead wait until the print head closes and repeat the operation to insert the transport plate.

20. Close the printer hood.

21. Retighten the red cap (→ "Fig. 60-2") on the transport cartridge and close the cover plate on the side of the printer.

**Warning**

- Switch off the printer and disconnect the power to prevent damage to the print head!
- Never use a transport cartridge together with a replacement plate!
- In order to use the printer again, the transport plate has to be removed and a new exchange plate has to be inserted.
- Do not reinstall a used transport plate, as it will no longer completely seal the print head.

22. Likewise, clean the removed replacement plate (→ "Fig. 66-1") with the sealing lip (→ "Fig. 66-2") with (clean) alcohol and a cleaning swab (→ "Fig. 66-3").

23. The sealing lip (→ "Fig. 66-2") must be completely free of ink residue. Check the sealing lip for damage.

**Warning**

Do not reuse a replacement plate with a damaged sealing lip!



Fig. 66

24. Clean the instrument completely, as described in this chapter.

6.6 Transporting the instrument

If the printer is to be shipped, the storage instructions described above are to be carried out completely.

Then, additionally make the following preparations:

1. Open the hood (→ "Fig. 33-1") of the printer and loosen the screw of the flash cover.
2. Then take out the flash bulb. For more information, refer to (→ p. 32 – 4.6 *Installing/exchanging the flash bulb*).
3. Close the flash cover and the hood.
4. Use original packaging and securely screw the printer to the baseplate (see unpacking instructions).
5. Reinsert the transport anchor (→ "Fig. 13-1") and secure the hood with adhesive tape.
6. Make sure that the instrument is only transported upright.

7. Troubleshooting

7.1 Malfunctions



Note

If the printer malfunctions during printing, a corresponding error code is displayed and simultaneously the **LED** in the **ERROR** button starts flashing.



How to eliminate the problem:

1. Determine the cause of the error using the error list (→ p. 77 – 7.3 Error messages).
2. Remove obstruction(s); open lid if required.



Warning

Important!

Remove all cassettes which are still in the chute, in or next to the cassette carrier or in the drying module. These cassettes should not be reused.

Confirm elimination of error:

1. Close the lid and press **ERROR** to confirm to the printer that the source of the error has been eliminated.



2. The printer then verifies whether all processing paths are unobstructed and whether the source of the error has been eliminated.
3. If there are still some obstructions left, or if the source of error has not been completely eliminated, the printer displays another error message.
4. Interrupted print jobs are resumed where previously left off.
5. If an error message is displayed several times although all possible causes have been eliminated, a Reset should be carried out.

Reset:

1. Press and release **LOADED** and **ERROR** simultaneously.







2. A Reset restores the printer to the same state as directly after switching on. All print jobs in the print queue are deleted.
3. If the same error continues to be displayed even after a reset, switch the printer off via the power switch (back panel) and, after a short waiting period of approx. 30 sec., switch it back on. If this does not eliminate the problem either, call Leica Technical Service.









7.2 Status messages











(for additional information, refer also to ([→ p. 55 – 5.2 Display indications](#)))













Display code	LED	Meaning
	MAG. EMPTY flashing	The printer is waiting for an individual cassette to be placed in the feeding chute for printing.
	MAG. EMPTY flashing	Magazine no. 1 empty
	MAG. EMPTY flashing	Magazine no. 2 empty
	MAG. EMPTY flashing	Magazine no. 3 empty
	MAG. EMPTY flashing	Magazine no. 4 empty
	MAG. EMPTY flashing	Magazine no. 5 empty
	MAG. EMPTY flashing	Magazine no. 6 empty
	–	Ink print head cleaning is in progress.
	–	Temperature in the flash power supply is too high.



Display code	LED	Meaning
	–	Flash bulb has reached its maximum life.
	–	Prompt requesting maintenance.
	–	Prompt to clean the print head.
	INK EMPTY flashing	Ink cartridge has been changed; instrument waiting for confirmation via ERROR , CLEAN , or LOADED button.

7.3 Error messages

Display code	Source of error	Troubleshooting solution
	Magazine output mechanically blocked.	Remove the cause of the blockage.
	Faulty ejection of a cassette. Magazine output blocked.	Remove cassette.
	Transfer of a cassette from the chute to the cassette carrier failed. Horizontal motor either incorrectly positioned or mechanically blocked.	Remove cassette.
	Cassette is stuck in the feeding chute.	Remove cassette.
	Horizontal drive is mechanically blocked.	Close the swivelling flap of the flash module (→ "Fig. 51-1"). Remove cassette. If error persists, call Leica Technical Service.
	Vertical drive is mechanically blocked.	Remove cassette. If error persists, call Leica Technical Service.
	Rotational motion is mechanically blocked.	Remove cassette. If error persists, call Leica Technical Service.
	Cassette not correctly clamped in cassette carrier. Cassette did leave the feeding chute but did not reach the cassette carrier.	Remove the cassette from the cassette carrier.

Display code	Source of error	Troubleshooting solution
	Cassette did not leave the cassette carrier or was still located in the cassette carrier during initialization.	Remove the cassette from the cassette carrier.
	The ink print head is getting too hot. Ambient temperature too high or electronics defective.	Switch instrument off and let it cool off. The instrument remains disabled until the print head has cooled down to a temperature value within the permissible range. Check ambient temperature.
	No or incorrect voltage at ink print head.	Call Leica Technical Service.
	<ul style="list-style-type: none"> Cover (→ "Fig. 1-5") not closed properly. Safety switch triggered. Flash standby state not reached within the prescribed time. Charging electronics defective. 	<ul style="list-style-type: none"> Ensure that the cover is not blocked, e.g. by the manual unload station. Close cover completely. Call Leica Technical Service.
	No flash or flash duration too short. Flash bulb dirty or defective.	Check whether flash bulb works – to do so, observe the stray light on the cover. Never open the cover to check whether a flash is triggered! No flash --> install a new flash bulb (→ p. 32 – 4.6 Installing/exchanging the flash bulb).
	Unload station mechanically blocked.	Remove the cause of the blockage.
	Heater fan not running or running too slowly.	Call Leica Technical Service.
	No cassette is in the drying module for flashing. Cassette left the cassette carrier, but did not reach the drying module.	Remove cassette.
	Cassette not successfully ejected from drying module.	Remove cassette.
	Cassette in the drying module during initialization or prior to a print job being carried out.	Remove the cause of the blockage.
	The flap of the drying module either does not close or does not open. The flap is blocked (e.g. by a cassette).	Remove the cause of the blockage.

Display code	Source of error	Troubleshooting solution
	Lifting table end sensor does not switch.	Call Leica Technical Service.
	Lifting table position sensor does not switch during positioning.	Call Leica Technical Service.
	Flash power supply: Overtemperature for more than 10 minutes.	Call Leica Technical Service.
	Faulty control data received (program bug). Settings for the serial interface incorrect or the instrument configuration conflicts with the PC configuration.	Carry out a RESET on the printer. Check cable connection to the PC. Check configuration of serial port of the PC and reboot the PC.
	Transmitted data do not contain confirmation of receipt or data transmission was not confirmed by the PC.	Follow the same procedure as for ERROR 60 . Try another printer cable.
	Print image exceeding the vertical limit.	Error caused by application software.
	Print image exceeding the horizontal limit.	Error caused by application software.
	The CRC test of the EEPROM returned an error when the instrument was switched on.	Call Leica Technical Service.
	Internal firmware error or defective controller.	Call Leica Technical Service.
		
	Mechanical problem makes ejection of cassettes from magazine difficult.	Check ejection mechanism. Remove foreign bodies, then clean with brush.
		
	A print job was attempted with a storage fluid cartridge inserted.	Remove storage cartridge. Insert ink cartridge and press LOADED to confirm (→ p. 41 – 4.9 Exchanging the transport cartridge for an ink cartridge).

Display code	Source of error	Troubleshooting solution
	Power supply unit does not achieve standard operating voltage.	Call Leica Technical Service.
	Firmware only partially loaded or not loaded at all. Flash memory defective.	Call Leica Technical Service.
	Wrong firmware.	Call Leica Technical Service.

7.4 Changing the flash bulb

Code **13** appears on the printer display when the flash bulb has reached its maximum service life.



When code **13** is issued, the bulb has to be changed.

For details on how to insert/replace the flash bulb, please refer to ([→ p. 32 – 4.6 Installing/exchanging the flash bulb](#)).



Warning

Before replacing the flash bulb, switch off the printer and unplug the instrument from power supply.

10 s

1. After changing the bulb, switch the printer back on.
2. Then go to offline mode and hold down the **ERROR** key for 10 seconds; code "**13**" disappears from the display.

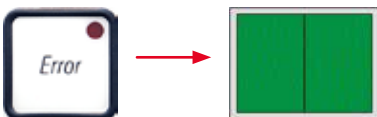

Warning

If a defective flash bulb has been replaced without the message "**13**" appearing on the display, likewise confirm this using the above procedure (hold down the **ERROR** key for at least 10 sec.).

7.5 Power failure

- Check whether there is a general power failure (no power).
- Check whether the power plug is inserted correctly into the wall outlet and whether the wall outlet is switched on, if applicable.
- Check whether the power switch is switched on correctly. The primary fuse may have tripped. If so, the main switch will be in "0" = **OFF** position (→ "Fig. 67-1").



Fig. 67

- Check whether one of the two secondary fuses (→ "Fig. 68") is defective (**F1**, **F2** on the back panel of instrument (→ "Fig. 69")).
- Some instrument malfunctions/failures are caused by defective fuses.



Fig. 68

Malfunction/failure

- Instrument not functioning.
- No display indication.
- Instrument not working at normal speed.
Printing a cassette takes approx. 8 sec., even after the warm-up phase has been completed.

Fuse to be checked

- Fuse **F2**
- Fuse **F2**
- Fuse **F1**

7.6 Replacing the secondary fuses



Warning

Before replacing a fuse, always switch the instrument off and unplug from power supply. Defective fuses may be replaced only with the replacement fuses supplied together with the instrument.

Replacing the fuses

1. Insert a screwdriver (→ "Fig. 69-2") into the slot in fuse holder (→ "Fig. 69-1"); push slightly inwards and at the same time rotate the screwdriver a 1/4 turn to the left.



Fig. 69

2. The fuse holder is released and can be removed.
3. Remove the defective fuse (→ "Fig. 70-2") from the fuse holder (→ "Fig. 70-1") and insert the correct type replacement fuse.



Fig. 70

4. Insert the fuse holder with the replacement fuse. Push the holder in with the screwdriver and secure it with a 1/4 turn to the right.

8. Warranty and Service

Warranty

Leica Biosystems Nussloch GmbH guarantees that the contractual product delivered has been subjected to a comprehensive quality control procedure based on the Leica in-house testing standards, and that the product is faultless and complies with all technical specifications and/or agreed characteristics warranted.

The scope of the warranty is based on the content of the concluded agreement. The warranty terms of your Leica sales organization or the organization from which you have purchased the contractual product shall apply exclusively.

Yearly Preventive Maintenance

Leica recommends conducting a yearly preventive maintenance. This has to be performed by a qualified Leica Service Representative.

Technical service information

If you require technical service or replacement parts, please contact your Leica sales representative or dealer who sold the product.

Please provide the following information:

- Model name and serial number of the instrument.
- Location of the instrument and name of the person to contact.
- Reason for the service call.
- Date of delivery.

Shutdown and disposal of the instrument

The instrument or parts of the instrument must be disposed of in compliance with the local laws.

For information about correct disposal of the ink cartridge, follow the instructions of the Material Safety Data Sheet (see <https://www.msdsonline.com>).

9. Decontamination Certificate

Every product that is returned to Leica Biosystems or that requires on-site maintenance must be properly cleaned and decontaminated. You can find the dedicated template of the decontamination confirmation on our website www.LeicaBiosystems.com within the product menu. This template has to be used for gathering all required data.

When returning a product, a copy of the filled and signed confirmation has to be enclosed or passed on to the service technician. The responsibility for products that are sent back without this confirmation or with an incomplete confirmation lies with the sender. Returned goods that are considered to be a potential source of danger by the company will be sent back at the expense and risk of the sender.

www.LeicaBiosystems.com



Leica Biosystems Nussloch GmbH
Heidelberger Strasse 17 - 19
69226 Nussloch
Germany

Phone: +49 - (0) 6224 - 143 0
Fax: +49 - (0) 6224 - 143 268
Web: www.LeicaBiosystems.com