

HistoCore SPECTRA ST

Stainer



Instructions for Use
English

Order No.: 14 0512 80101 - Revision Z

Always keep this manual with the instrument.
Read carefully before working with the instrument.

CE

The information, numerical data, notes and value judgments contained in this Instructions for Use represent the current state of scientific knowledge and state-of-the-art technology as we understand it following thorough investigation in this field.

We are under no obligation to update the present Instructions for Use periodically and on an ongoing basis according to the latest technical developments, nor to provide our customers with additional copies, updates etc. of this Instructions for Use.

To the extent permitted in accordance with the national legal system as applicable in each individual case, we shall not be held liable for erroneous statements, drawings, technical illustrations etc. contained in this Instructions for Use. In particular, no liability whatsoever is accepted for any financial loss or consequential damage caused by or related to compliance with statements or other information in this Instructions for Use.

Statements, drawings, illustrations and other information regarding the contents or technical details of the present Instructions for Use are not to be considered warranted characteristics of our products.

These are determined only by the contract provisions agreed between ourselves and our customers.

Leica reserves the right to change technical specifications as well as manufacturing processes without prior notice. Only in this way is it possible to continuously improve the technology and manufacturing techniques used in our products.

This document is protected under copyright laws. All copyrights to this documentation are held by Leica Biosystems Nussloch GmbH.

Any reproduction of text and illustrations (or of any parts thereof) by means of print, photocopy, microfiche, web cam or other methods – including any electronic systems and media – requires express prior permission in writing by Leica Biosystems Nussloch GmbH.

For the instrument serial number and year of manufacture, please refer to the nameplate on the back of the instrument.



Leica Biosystems Nussloch GmbH
Heidelberger Strasse 17 - 19
69226 Nussloch
Germany
Tel.: +49 - (0) 6224 - 143 0
Fax: +49 - (0) 6224 - 143 268
Web: www.LeicaBiosystems.com

Table of contents

1. Important Information	7
1.1 Symbols and their meanings	7
1.2 Instrument type	12
1.3 User Group	12
1.4 Intended purpose	12
1.5 Copyright - Instrument software	13
2. Security	14
2.1 Safety Notes	14
2.2 Warnings	15
2.3 Safety features on the instrument	19
3. Instrument Components and Specifications	20
3.1 Standard delivery	20
3.2 Specifications	21
3.3 General overview - front view	24
3.4 General overview - rear view	25
3.5 General overview - inside view	26
4. Installation and Starting Up	27
4.1 Installation site requirements	27
4.2 Rinsing water connection	28
4.2.1 Joint connection of all 6 rinsing water stations	29
4.2.2 Combined connection 4+2 rinsing water stations	30
4.2.3 Wastewater connection	31
4.3 Electrical connection	31
4.3.1 Using an external uninterruptible power supply (UPS)	32
4.4 Exhaust air connection	33
4.5 Switching the instrument on and off	33
5. Operation	35
5.1 User interface - overview	35
5.2 Elements of the status display	36
5.3 Process status display	37
5.4 Displaying the drawers	39
5.5 Main menu - overview	40
5.5.1 The keyboard	41
5.6 User settings	43
5.7 Basic settings	45
5.7.1 Language settings	45
5.7.2 Regional settings	46
5.7.3 Date and time	47
5.7.4 Menu for alarm tones – Error and signal tones	47
5.7.5 Oven settings	49
5.7.6 Movement speed - up/down movement (agitation)	50
5.7.7 Data management	51
5.7.8 Service access	55
5.7.9 Event viewer	56

5.8	Reagent list	58
5.8.1	Copying a reagent	61
5.8.2	Changing the RMS data for a reagent	61
5.8.3	Process classes	62
5.9	Staining programs	64
5.9.1	Assigning a rack handle color to a staining program	65
5.9.2	Leica staining programs (preinstalled)	67
5.9.3	Adapting the Leica H&E staining program	68
5.9.4	User-defined staining programs	70
5.9.5	Creating or copying a new staining program	70
5.9.6	Inserting or copying a new program step	73
5.9.7	Re-sorting program steps	75
5.9.8	Prioritizing programs for executing the bathlayout	76
5.9.9	Executing the bathlayout	77
5.9.10	Filling reagents after bathlayout execution	78
5.9.11	Adapting a bathlayout	85
6.	Daily Instrument Setup	89
6.1	Preparing the instrument for daily setup	89
6.2	Daily instrument setup	90
6.2.1	Preparation and handling of reagent vessels	90
6.2.2	Automatic fill level scan	92
6.3	Reagent management system (RMS)	93
6.4	Station details	94
6.5	Preparing the rack	101
6.6	The staining process	105
6.6.1	Starting the staining process	105
6.6.2	Monitoring the staining process	107
6.6.3	Staining process finished	108
6.6.4	Canceling the staining program	109
6.6.5	Operation as a workstation	111
6.6.6	Finishing the daily operation	113
7.	Cleaning and Maintenance	114
7.1	Important notes about cleaning this instrument	114
7.2	Exterior surfaces, varnished surfaces, instrument hood	114
7.3	TFT touchscreen	115
7.4	Interior and drain pan	115
7.5	Transport arms	115
7.6	Specimen slide counter station	115
7.7	Load and unload drawers	116
7.8	Dry transfer station	117
7.9	Transfer station (optional)	117
7.10	Reagent vessels and rinsing water vessels	117
7.11	Rack and handle	119
7.12	Water drainage	120
7.13	Water drain hose	121
7.14	Replacing the filter cartridge of the water intake filter	121
7.15	Changing the active carbon filter	122
7.16	Cleaning the ovens	123
7.17	Oven air filter	125

Table of contents

7.18	Maintenance and cleaning intervals	125
7.18.1	Daily cleaning and maintenance.....	126
7.18.2	Cleaning and maintenance as necessary	126
7.18.3	Weekly cleaning and maintenance	127
7.18.4	Monthly cleaning and maintenance.....	127
7.18.5	Cleaning and Maintenance Every Three Months	127
7.18.6	Annual cleaning and maintenance	127
8.	Malfunctions and Troubleshooting	128
8.1	Fault remedies for instrument malfunctions	128
8.2	Power failure scenario and instrument malfunction	131
8.2.1	Procedure after a power failure.....	133
8.2.2	Resuming the staining process after a power failure.....	136
8.2.3	Canceling all staining processes after a power failure.....	137
8.2.4	Detaching a rack from the gripper mechanism.....	139
8.2.5	Removal of a rack from the transfer station.....	141
8.3	Replacing main fuses	142
8.4	Water drain system blocked.....	143
8.5	Errors when attaching, detaching or transporting racks.....	148
9.	Instrument Components and Specifications	150
9.1	Optional instrument components	150
9.2	Optional accessories	150
10.	Warranty and Service	160
11.	Decommissioning and Disposal	161
12.	Decontamination Confirmation	162
A1.	Appendix 1 - Compatible reagents.....	163

1. Important Information

1.1 Symbols and their meanings



Warning

Leica Biosystems Nussloch GmbH assumes no liability for consequential loss or damage due to failure to observe the following instructions, particularly in relation to transportation and package handling, and failure to observe the instructions for handling the instrument carefully.

Symbol:



Title of the symbol:

Hazard warning

Description:

Warnings are displayed in a white field with an orange title bar. Warnings are identified by a warning triangle.

Symbol:



Title of the symbol:

Note

Description:

Notes, i.e. important information for the user, are displayed in a white field with a blue title bar. Notes are identified by a notification symbol.

Symbol:

→ "Fig. 7 - 1"

Title of the symbol:

Item number

Description:

Item numbers for numbering illustrations. Numbers in red refer to item numbers in illustrations.

Symbol:

Supervisor

Title of the symbol:

Function key

Description:

Software designations that have to be displayed on the input screen are displayed as bold, gray text.

Symbol:

Save

Title of the symbol:

Function key

Description:

Software symbols that have to be pressed on the input screen are displayed as bold, gray and underlined text.

Symbol:

Power switch

Title of the symbol:

Keys and switches on the instrument

Description:

Keys and switches on the instrument that are supposed to be pressed by the user in various situations are displayed as bold, gray text.

Symbol:



Title of the symbol:

Attention

Description:

Indicates the need for the user to consult the Instructions for Use for important cautionary information such as warnings and precautions that cannot, for a variety of reasons, be presented on the medical device itself.

Symbol:



Title of the symbol:

Warning, hot surface

Description:

Instrument surfaces which become hot during operation are marked with this symbol. Avoid direct contact to prevent risk of burning.

Symbol:























Title of the symbol:







Manufacturer

Description:

Indicates the manufacturer of the medical product.

Symbol: 	Title of the symbol: Description:	Manufacturing date Indicates the date when the medical device was manufactured.
Symbol: 	Title of the symbol: Description:	CE Label The CE marking is the manufacturer's declaration that the medical product meets the requirements of the applicable EC directives and regulations.
Symbol: 	Title of the symbol: Description:	UKCA Label The UKCA (UK Conformity Assessed) marking is a new UK product marking that is used for goods being placed on the market in Great Britain (England, Wales and Scotland). It covers most goods which previously required the CE marking.
Symbol: 	Title of the symbol: Description:	CSA Statement (Canada/USA) CSA mark shown with adjacent indicators 'C' and 'US' for Canada and US (indicating that products have been manufactured to the requirements of both Canadian and US Standards) or with adjacent indicator 'US' for US only or without either indicator for Canada only.
Symbol: 	Title of the symbol: Description:	In vitro diagnostic medical device Indicates a medical device that is intended to be used as an in vitro diagnostic medical device.
Symbol: 	Title of the symbol: Description:	China RoHS Environmental protection symbol of the China ROHS directive. The number in the symbol indicates the "Environment-friendly Use Period" of the product in years. The symbol is used if a substance restricted in China is used in excess of the maximum permitted limit.
Symbol: 	Title of the symbol: Description:	WEEE Symbol The WEEE symbol, indicating separate collection for WEEE - Waste of electrical and electronic equipment, consists of the crossed-out wheeled bin (§ 7 ElektroG).
Symbol: 	Title of the symbol:	Alternating current
Symbol: 	Title of the symbol: Description:	Article number Indicates the manufacturer's catalog number so that the medical device can be identified.
Symbol: 	Title of the symbol: Description:	Serial number Indicates the manufacturer's serial number so that a specific medical device can be identified.

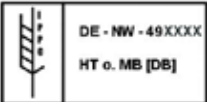
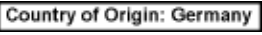
Symbol:	Title of the symbol:	Consult Instructions for Use
	Description:	Indicates the need for the user to consult the Instructions for Use.
Symbol:	Title of the symbol:	UDI
	Description:	Indicates a carrier that contains Unique Device Identifier information. The use of this symbol is optional, but may be used when multiple data carriers are present on the label. If used, this symbol shall be placed adjacent to the Unique Device Identifier carrier. NOTE Used to identify which information is associated with Unique Device Identifier.
 (01)04049188191953		
Symbol:	Title of the symbol:	UK Responsible Person
	Leica Microsystems (UK) Limited Larch House, Woodlands Business Park, Milton Keynes England, United Kingdom, MK14 6FG	
	Description:	The UK Responsible Person acts on behalf of the non-UK manufacturer to carry out specified tasks in relation to the manufacturer's obligations.
Symbol:	Title of the symbol:	ON (Power)
	Description:	The power supply is connected upon pushing the power switch .
Symbol:	Title of the symbol:	OFF (Power)
	Description:	The power supply is disconnected upon pushing the power switch .
Symbol:	Title of the symbol:	PE terminal
	Description:	
Symbol:	Title of the symbol:	Warning, risk of electric shock
	Description:	Instrument surfaces or areas which become energized during operation are marked with this symbol. Therefore, direct contact is to be avoided.
Symbol:	Title of the symbol:	Caution: danger of crushing
		
Symbol:	Title of the symbol:	Do not touch
	Description:	Do not touch parts of the device to which this symbol is attached.

Symbol:	Title of the symbol:	Flammable
	Description:	Flammable reagents, solvents and cleaning agents are labeled with this symbol.
Symbol:	Title of the symbol:	Warning, biological hazard
	Description:	Instrument parts close to this symbol may be contaminated with substances that pose a threat to health. Avoid direct contact or use appropriate protective clothing.
Symbol:	Title of the symbol:	Observe the laser beam warning and Instructions for Use
	Description:	The product uses a class 1 laser source. The safety notes for handling lasers and the Instructions for Use must be observed.
Symbol:	Title of the symbol:	Do not use any kind of alcohol for cleaning and observe the Instructions for Use
	Description:	Indicates that the use of alcohol or alcohol containing cleaning agents for cleaning the item/part this symbol is applied to is prohibited. Using alcohol or alcohol containing cleaning agents for cleaning will destroy the item/part.
Symbol:	Title of the symbol:	IPPC symbol
	Description:	The IPPC symbol includes: IPPC symbol <ul style="list-style-type: none"> • Country code to ISO 3166, e.g. DE for Germany • Regional identifier, e.g. NW for North Rhine-Westphalia • Registration number, unique number beginning with 49 • Treatment method, e.g. HT (heat treatment)
Symbol:	Title of the symbol:	Country of Origin
	Description:	The Country of Origin box defines the country where the final character transformation of the product has been performed.
Symbol:	Title of the symbol:	Fragile, handle with care
	Description:	Indicates a medical device that can be broken or damaged if not handled carefully.
Symbol:	Title of the symbol:	Store dry
	Description:	Indicates a medical device that needs to be protected from moisture.

Symbol:



Title of the symbol:

Stack limit

Description:

The largest number of identical packages allowed to be stacked; "2" stands for the number of permitted packages.

Symbol:



Title of the symbol:

This way up

Description:

Indicates correct upright position of the transport package.

Symbol:

Transport temperature range:

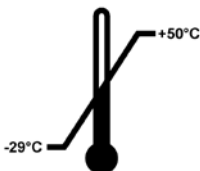

Title of the symbol:

Temperature limit for transport

Description:

Indicates the temperature limits for transport to which the medical device can be safely exposed.

Symbol:

Storage temperature range:

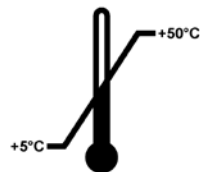

Title of the symbol:

Temperature limit for storage

Description:

Indicates the temperature limits for storage to which the medical device can be safely exposed.

Symbol:



Title of the symbol:

Humidity limitation for transport and storage

Description:

Indicates the range of humidity for transport and storage to which the medical device can be safely exposed.

Appearance:



Indication:

Tilt indicator

Description:

Indicator to monitor whether the shipment has been transported and stored in upright position according to your requirements. With a pitch of 60° or more, the blue quartz sand flows into the arrow-shaped indicator window and sticks there permanently. Improper handling of the shipment is immediately detectable and can be proven definitively.

**Note**

- Upon delivery of the instrument, the recipient must check that the tilt indicator is intact. The responsible Leica representative must be notified in the case that all indicators have been triggered.
- The Instructions for Use are accompanied by a bound "RFID Registration" brochure. The brochure contains country-specific information for the user about the meaning of the RFID symbols and registration numbers available on the packaging or the HistoCore SPECTRA ST nameplate.

1.2 Instrument type

All information provided in these Instructions for Use applies only to the instrument type indicated on the title page. A nameplate indicating the instrument serial number is attached to the rear side of the instrument. Furthermore, a plate with Chinese and Japanese registration information is located on the rear panel of the instrument.

1.3 User Group

- The HistoCore SPECTRA ST must only be operated by authorized personnel comprehensively trained in using lab reagents and their application in histology.
- All laboratory personnel designated to operate this instrument must read these Instructions for Use carefully and must be familiar with all technical features of the instrument before attempting to operate it. The instrument is intended for professional use only.

1.4 Intended purpose

The HistoCore SPECTRA ST is an automated stainer specifically designed for staining of human tissue specimens in order to contrast cell formations and their components used for histological medical diagnosis by a pathologist, e.g. for cancer diagnosis.

The HistoCore SPECTRA ST is designed for in vitro diagnostic applications.

**Warning**

Any use of the instrument that deviates from the intended purpose is considered improper. Failure to adhere to these instructions may result in an accident, personal injury, damage to the instrument or accessory equipment. Proper and intended purpose includes compliance with all inspection and maintenance instructions, along with the observance of all instructions in the Instructions for Use as well as the constant inspection of the reagents for storage life and quality. The HistoCore SPECTRA ST carries out the specified staining steps automatically. The manufacturer assumes no liability for the staining results in the case that the staining steps and programs are entered incorrectly. Thus, the end user is independently responsible for self-created reagents or program entries.

1.5 Copyright - Instrument software

The software installed and used on the HistoCore SPECTRA ST is subject to the following license agreements:

1. GNU General Public License Version 2.0, 3.0
2. GNU Lesser General Public License 2.1
3. additional software not licensed under the GPL/LGPL

The complete license agreements for the first and second items in the list can be found on the provided language CD (→ [P. 20 – 3.1 Standard delivery](#)) in the **Software Licenses** directory.

Leica Biosystems provides a complete machine-readable copy of the source code to every third party in compliance with the agreements of the GPL/LGPL applicable for the source code or of the other applicable licenses. To contact us, go to www.leicabiosystems.com and use the corresponding contact form.

2. Security

2.1 Safety Notes



Warning

- The safety and caution notes in this chapter must be observed at all times. Be sure to read these notes even if you are already familiar with the operation and use of other Leica instruments.
- The protective devices located on the instrument and the accessories must not be removed or modified.
- Only qualified service personnel authorized by Leica may repair the instrument and access its internal components.

Residual risks:

- The instrument has been designed and constructed with the latest state-of-the-art technology and according to recognized standards and regulations with regard to safety technology. Operating or handling the instrument incorrectly can place the user or other personnel at risk of injury or death or can cause damage to the instrument or property.
- The instrument may be used only as intended and only if all of its safety features are in proper working condition.
- If malfunctions occur that can impede safety, the instrument must be put out of operation immediately and the responsible Leica service technician must be notified.
- Only original spare parts and permitted original Leica accessories may be used.
- Electromagnetic compatibility, emitted interference and immunity to interference are applicable, as are the requirements in accordance with IEC 61326-2-6. The requirements in accordance with IEC 61010-1, IEC 61010-2-101, IEC 62366 and ISO 14971 with regard to safety information are applicable.

These Instructions for Use include important instructions and information related to the operating safety and maintenance of the instrument.

The Instructions for Use are an important part of the instrument, and must be read carefully prior to startup and use and must always be kept near the instrument.



Note

These Instructions for Use must be appropriately supplemented as required by the existing regulations on accident prevention and environmental safety in the operator's country.

The instrument's EC Declaration of Conformity and UKCA Declaration of Conformity can be found on the Internet at:

<http://www.LeicaBiosystems.com>

This instrument has been built and tested in accordance with the safety requirements for electrical equipment for measurement, control, and laboratory use. To maintain this condition and ensure safe operation, the user must observe all notes and warnings contained in these Instructions for Use.

**Warning**

- The presence of malware on the system can lead to uncontrolled system behavior. Ensuring that the behavior of the instrument conforms to specifications is no longer possible in this case! If the user suspects malware is on the system, the local IT department must be notified immediately.
- You must make sure that any data loaded onto the instrument is free of viruses. No anti-virus software is provided.
- The instrument is only suited for integration in a firewall-protected network. Leica shall not assume any liability for errors due to integration in an unprotected network.
- ONLY technicians trained and permitted by Leica can connect a USB input device (mouse/keyboard, etc.).

In the interest of specimen safety, the HistoCore SPECTRA ST indicates when it is necessary for the user to intervene using on-screen messages and audible signals. Therefore, the HistoCore SPECTRA ST stainer requires that the user is within hearing distance during operation.

**Warning**

The product uses a Class 1 laser source.

Attention, laser radiation! Do not look into the beam! This can cause injury to the retina of the eye.

**Warning**

LASER RADIATION - DO NOT
STARE INTO BEAM
IEC 60825-1: 2014
P<390 µW, λ = 630 to 670 nm
PWM frequency: 1 kHz
Duty cycle: 16.4 %
Class 1 laser product

2.2 Warnings

The safety devices installed in this instrument by the manufacturer only constitute the basis for accident prevention. Operating the instrument safely is, above all, the responsibility of the owner, as well as the designated personnel who operate, service or repair the instrument.

To ensure trouble-free operation of the instrument, make sure to comply with the following instructions and warnings.

Please note that electrostatic discharges can result due to direct or indirect contact with the HistoCore SPECTRA ST.

**Warning**

Markings on the instrument surface showing the warning triangle indicate that the correct operating instructions (as defined in these Instructions for Use) must be followed when operating or replacing the item marked. Failure to adhere to these instructions may lead to accidents causing personal injury and/or damage to the instrument or accessories or destroyed, unusable specimens.



Warning

Certain surfaces of the instrument are hot during operation under normal conditions. They are marked with this warning sign. Touching these surfaces without suitable safety measures can cause burns.

Warnings - Transport and installation



Warning

- The instrument must only be transported in an upright position.
- The empty weight of the instrument is 165 kg; therefore, four qualified persons are required to lift or carry the instrument.
- Use non-skid gloves to lift the instrument.
- Leica recommends commissioning a transport company to transport, install or (where applicable) relocate the instrument.
- Retain the instrument packaging.
- Place the instrument on a sturdy laboratory bench which has a sufficient load capacity and adjust it to a horizontal position.
- Prevent the instrument from being exposed to direct sunlight.
- Only connect the instrument to a grounded power socket. Do not interfere with the grounding function by using an extension cord without a ground wire.
- Exposure to extreme temperature changes between storage and installation locations and high air humidity may cause condensation inside the instrument. If this is the case, wait at least two hours before switching on the instrument.
- The instrument must only be installed at the area of use with and under direction of Leica-trained staff. This also applies to the potential transport to a new area of use. We recommend using personnel trained by Leica to recommission the instrument.
- To ensure proper function of the instrument, it must be set up with a minimum distance of 100 mm on all sides from walls and furniture.
- In accordance with national rules and regulations, the operator may be obligated to provide long-term protection of the public water supply from contamination due to backflowing water from the building installation. In Europe, the protection device of the potable water installation to be connected is selected in accordance with the specifications of DIN EN 1717:2011-08 (information status August 2013).

Warnings – Handling reagents**Warning**

- Exercise caution when handling solvents.
- Always wear protective clothing suitable for laboratory use, as well as rubber gloves and safety goggles when handling the chemicals used in this instrument.
- The installation site must be well-ventilated. In addition, we highly recommend connecting the instrument to an external exhaust air extraction system. The chemicals to be used in the HistoCore SPECTRA ST are flammable and hazardous to health.
- Do not operate the instrument in rooms with an explosion hazard.
- The user is responsible for monitoring the expiration date of other reagents used with the HistoCore SPECTRA ST (e. g. xylene in the reagent vessels). Expired reagents must be replaced immediately and disposed of. When disposing of consumed, expired or used-up reagents, the applicable local regulations and the waste disposal regulations of the company/institution in which the instrument is being operated have to be observed.
- When disposing of spent reagents, observe the applicable local regulations and the waste disposal regulations of the company/institution in which the instrument is being operated.
- Reagent vessels must always be filled outside of the instrument in compliance with the safety information.

Warnings – Operating the instrument**Warning**

- The instrument may be operated by trained laboratory personnel only. It must only be operated for the purpose of its designated use and according to the instructions contained in these Instructions for Use. Antistatic protective clothing made from natural fibers (e.g. cotton) should be worn when working with the instrument.
- When working with the instrument, wear suitable protective clothing (lab coat, safety goggles and gloves) for protection against reagents and potentially infectious micro-biological contamination.
- In the event of an emergency, shut down the **power switch** and unplug the instrument from the power supply (circuit breaker in accordance with EN ISO 61010-1).
- For severe instrument faults, the warning and error messages on the screen must be followed. Samples located in the process must be removed from the instrument immediately. The user is responsible for the safe further processing of the samples.
- There is a fire hazard if work with an exposed flame (e.g. Bunsen burner) is carried out in the direct vicinity of the instrument (solvent vapors). Therefore, keep all ignition sources at least 2 meters away from the instrument.
- Be absolutely certain to operate the instrument with the active carbon filter. In addition, we highly recommend connecting the instrument to an external exhaust air extraction system because use of the instrument may lead to the formation of solvent vapors that are both hazardous to health and flammable, even when the instrument is used according to its intended purpose.
- The use of Power over Ethernet (PoE) is not allowed using the RJ45 slot (→ "Fig. 2-1") located on the back of the instrument.
- The USB 2.0 slots (→ "Fig. 1-7") at the front of the instrument accepts only passive devices (without connection to the power supply, e. g. USB sticks).

**Note**

For instrument fume control, Leica recommends a delivery volume of 50 m³/h and an 8x air exchange rate (25 m³/m²/h) in the lab.



Warning

- In case the transport arm(s) must be lifted and moved, do not touch or move the transport arm(s) at the sensor/antenna area (→ "Fig. 115-6"). For this purpose lift the metallic part of the gripper (→ "Fig. 115-1") manually and move the transport arm(s) carefully to the necessary position.
- Personal protective clothing in the form of a respirator must be worn when working directly with reagent vessels that contain solvents.
- Opening the hood when one or more staining program(s) are active causes delays in the respective processing steps since no transport movements take place for this time frame. This can result in changes to the staining quality.
- Make sure to keep the hood closed if the staining programs are active. Leica assumes no liability for loss of quality for staining programs caused by opening the hood during the staining process.
- **CAUTION** when closing the hood: Crushing hazard! Do not reach into the swivel range of the hood.
- Liquid must not get behind covers or in gaps while operating or cleaning the instrument. This also applies to the transport arms.
- **CAUTION** for programs that start with an oven step! In this case, the load station from which the specimen slides are removed with the transport arm must **NOT** be filled with a flammable reagent (e.g. xylene, xylene substitute or alcohols). The oven temperature can be up to 70 °C. This can result in the reagent igniting and can cause damage to the instrument and specimens.
- The water supply has to be shut off during pauses in use of the instrument and when the instrument is shut down.

Warnings - Cleaning and Maintenance



Warning

- Before any maintenance, shut down the instrument and unplug it from its power supply.
- When cleaning the instrument, wear suitable protective clothing (lab coat and gloves) to protect from reagents and potentially infectious micro-biological contamination.
- When using cleaners, please comply with the safety instructions of the manufacturer and the laboratory safety regulations.
- Do not use any of the following for cleaning the outside surfaces of the instrument: alcohol, detergents containing alcohol (glass cleaners), abrasive cleaning powders, solvents containing acetone, ammonia, chlorine, or xylene.
- Do not use any alcohol or detergents containing alcohol for cleaning the water filter housing (→ "Fig. 5-5"). The consequence could be that water leaks in an uncontrolled manner and damages the laboratory and the laboratory environment.
- Clean the hoods and housing using mild commercial, pH-neutral household cleaners. The finished surfaces are not resistant to solvents and xylene substitutes!
- The plastic reagent vessels of the rinsing water and reagent stations can be cleaned in a dishwasher at a maximum temperature of +65 °C. Any standard cleaning agent for laboratory dishwashers may be used. Never clean the plastic reagent vessels at higher temperatures since higher temperatures can cause the reagent vessels to become deformed.

2.3 Safety features on the instrument

As soon as the hood of the instrument is opened, the movements of the transport arms are stopped in a horizontal plane (x and y-axis) for safety reasons to eliminate danger to the user and specimen damage due to collision with moving parts.



Warning

- Make sure to keep the hood closed if the staining programs are active. Leica assumes no liability for loss of quality for staining programs caused by opening the hood during the staining process.
- Opening the hood when one or more staining program(s) is/are active causes delays in the respective processing steps since no transport movements take place for this time frame. This can result in changes to the staining quality.
- To ensure smooth operation of the instrument software, the instrument must be restarted by the user at least every 3 days.

3. Instrument Components and Specifications

3.1 Standard delivery

Qty.	Designation	Order No.
1	HistoCore SPECTRA ST Basic instrument (local power cord included)	14 0512 54354
1	Reagent vessel set consisting of: 46 reagent vessels with covers 6 blue rinsing water vessels 6 O-rings 7x2	14 0512 47507
1	Set of label covers for the load and unload drawers consisting of: • 10 pc. blank • 5 pc. "H ₂ O"=Water • 5 pc. "A"=Alcohol • 5 pc. "S"=Solvent, e.g. xylene)	14 0512 55161
1	Active carbon filter set (2 pcs.)	14 0512 53772
1	Outlet hose, 2 m	14 0512 55279
1	Tubing band clamp 30 45/12 DIN 3017 RF	14 0422 31972
1	Water connection kit consisting of:	14 0512 49324
2	Water inlet hose, 10 mm, 2.5 m	14 0474 32325
1	Extension hose, 1.5 m	14 0512 49334
2	Velcro Tie 200x12.5 black	14 0512 59906
1	Y-junction G3/4	14 3000 00351
2	Double nipple G3/4 G1/2	14 3000 00359
1	Filter housing	14 0512 49331
1	Filter cartridge	14 0512 49332
1	Pipe coupling G3/4	14 3000 00360
1	Blind cap G3/4	14 3000 00434
1	Seal washer	14 0512 54772
1	Single-head wrench SW30 DIN894	14 0330 54755
1	Exhaust hose, 2 m	14 0512 54365
2	Tubing band clamp 50 70/12 DIN 3017 RF	14 0422 31973
1	5.5 x 150 screwdriver	14 0170 10702
2	T16 A fuse	14 6000 04696
1	Molykote 111 grease, 100 g	14 0336 35460
3	Rack for 30 specimen slides; 3 pcs. per package	14 0512 52473
1	Handle for rack for 30 specimen slides; yellow, 3 pcs. per package	14 0512 52476
1	Handle for rack for 30 specimen slides; darkblue, 3 pcs. per package	14 0512 52478
1	Handle for rack for 30 specimen slides; red, 3 pcs. per package	14 0512 52480
1	Handle for rack for 30 specimen slides; white, 3 pcs. per package	14 0512 52484

Qty.	Designation	Order No.
1	International bundle Instructions for Use (incl. English printout and additional languages on a data storage device 14 0512 80200)	14 0512 80001

If the supplied local power cord is defective or lost, please contact your local Leica representative.



Note

The delivered components must be carefully compared against the packing list, delivery note, and your order. Should you find any discrepancies, please contact your Leica sales office without delay.

3.2 Specifications

Nominal supply voltages:	100-240 V AC \pm 10 %
Nominal frequency:	50/60 Hz
Power draw:	1580 VA
Fuses:	2 x T16 A H 250 V AC
Means of protection, in accordance with IEC 61010-1	Class I (PE connected)
Pollution degree, in accordance with IEC 61010-1	2
Overvoltage category, in accordance with IEC 61010-1	II
Degree of protection, in accordance with IEC 60529	IP20
A-weighted noise level, measured at 1 m distance	< 70 dB (A)
Heat emission	1580 J/s
Laser class, in accordance with IEC 60825-1	1
Minimum distance to walls and furniture:	100 mm on all sides
Fresh water connection:	
Hose material:	PVC
Hose length:	2500 mm, 1500 mm (extension hose)
Connecting piece:	G3/4
Inner diameter:	10 mm
Outer diameter:	16 mm
Internal pressure:	minimum/maximum: 2 bar/6 bar
Required water flow rate:	Min. 1.7 L/minute
Required tap water quality:	Drinking water quality, in accordance with applicable official regulations
Required DI water quality (optional connection):	ISO 3696: 1995 Type 3/ASTM D1193-91 Type IV
Waste water connection:	
Hose material:	PVC
Hose length:	2000 mm/4000 mm
Inner diameter:	32 mm
Outer diameter:	37 mm

3 Instrument Components and Specifications

Exhaust air:	
Hose material:	PVC
Hose length:	2000 mm
Inner diameter:	50 mm
Outer diameter:	60 mm
Exhaust performance:	27.3 m ³ /h
Exhaust extraction:	Active carbon filter and exhaust hose for connecting with an external exhaust system
Connections:	1 x RJ45 Ethernet (rear): RJ45 - LAN (external data management)
	1 x RJ45 Ethernet (front): Only for service purposes
	2 x USB 2.0: 5 V/500 mA (service & data storage)
Interfaces to other devices:	Interface to coverslipper HistoCore SPECTRA CV
Total number of stations:	42
Total number of reagent stations:	36
Wash stations:	6
Reagent vessel volume:	400 ml
Load stations:	5
Unload stations:	5
Number of oven stations:	6
Temperature of oven chamber:	40 °C to 70 °C
Permanent memory capacity:	50 programs
Max. number of steps/program:	50 steps
Step duration:	1 second to 23:59:59 (hh:mm:ss)



Note

When using an external uninterruptible power supply (UPS), it should be designed for a capacity of at least 1580 VA and secure operation over a time frame of at least 10 minutes.

Ambient conditions:

Environmental conditions	Indoor use only
--------------------------	-----------------

Operation:

Temperature:	+18 °C to +30 °C
Relative humidity:	20 % to 80 %, non-condensing
Operating elevation:	Up to a max. of 2000 m above sea level

Storage:

Temperature:	+5 °C to +50 °C
Relative humidity:	10 % to 85 %, non-condensing

Transport:

Temperature:	-29 °C to +50 °C
Relative humidity:	10 % to 85 %, non-condensing

Dimensions and weights:

Dimensions (Width x depth x height):	Hood closed: 1354 x 785.5 x 615 mm
	Hood open: 1354 x 785.5 x 1060 mm
Weight, empty (without transfer station, reagents and accessories)	165 kg
Weight, filled (with transfer station, reagents and accessories)	215 kg

3 Instrument Components and Specifications

3.3 General overview - front view

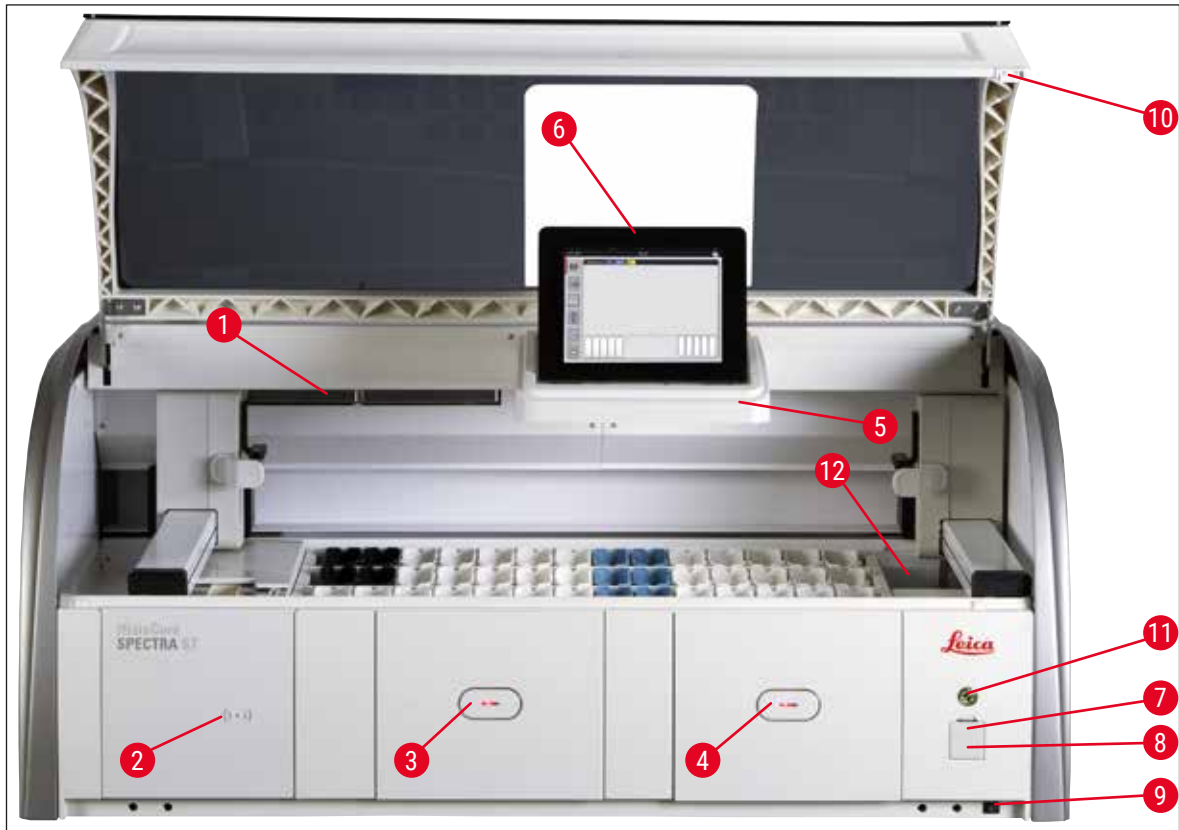

Fig. 1

- | | | | |
|---|--|----|--|
| 1 | Insert for active carbon filter | 7 | USB ports (2 pcs.) |
| 2 | Read-in area for Leica reagents | 8 | Service access |
| 3 | Load drawer (loader) | 9 | ON/OFF switch (power switch) |
| 4 | Unload drawer (unloader) | 10 | Hood |
| 5 | Screen holder with internal illumination | 11 | Operating switch |
| 6 | Screen with user interface | 12 | Transfer station (optional) |



Warning

- The service access (→ "Fig. 1-8") may only be used by Leica certified service technicians!
- The read-in area cover (→ "Fig. 1-2") may only be removed by Leica certified service technicians.

3.4 General overview - rear view

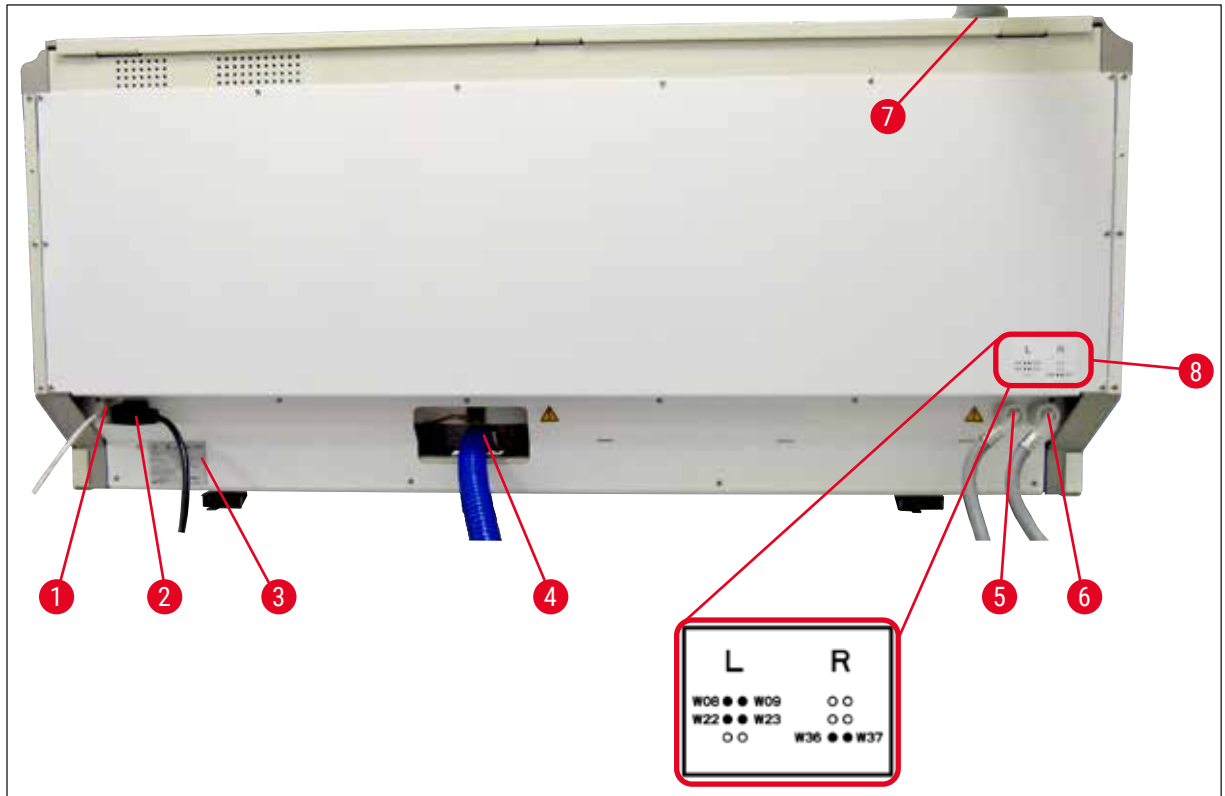

Fig. 2

- 1 Network connection (Disabled)
- 2 Power supply
- 3 Nameplate
- 4 Wastewater connection
- 5 Rinsing water connection (group of 4)
- 6 Distilled water or rinsing water connection (group of 2)
- 7 Exhaust air connection
- 8 Water connection diagram

3 Instrument Components and Specifications

3.5 General overview - inside view

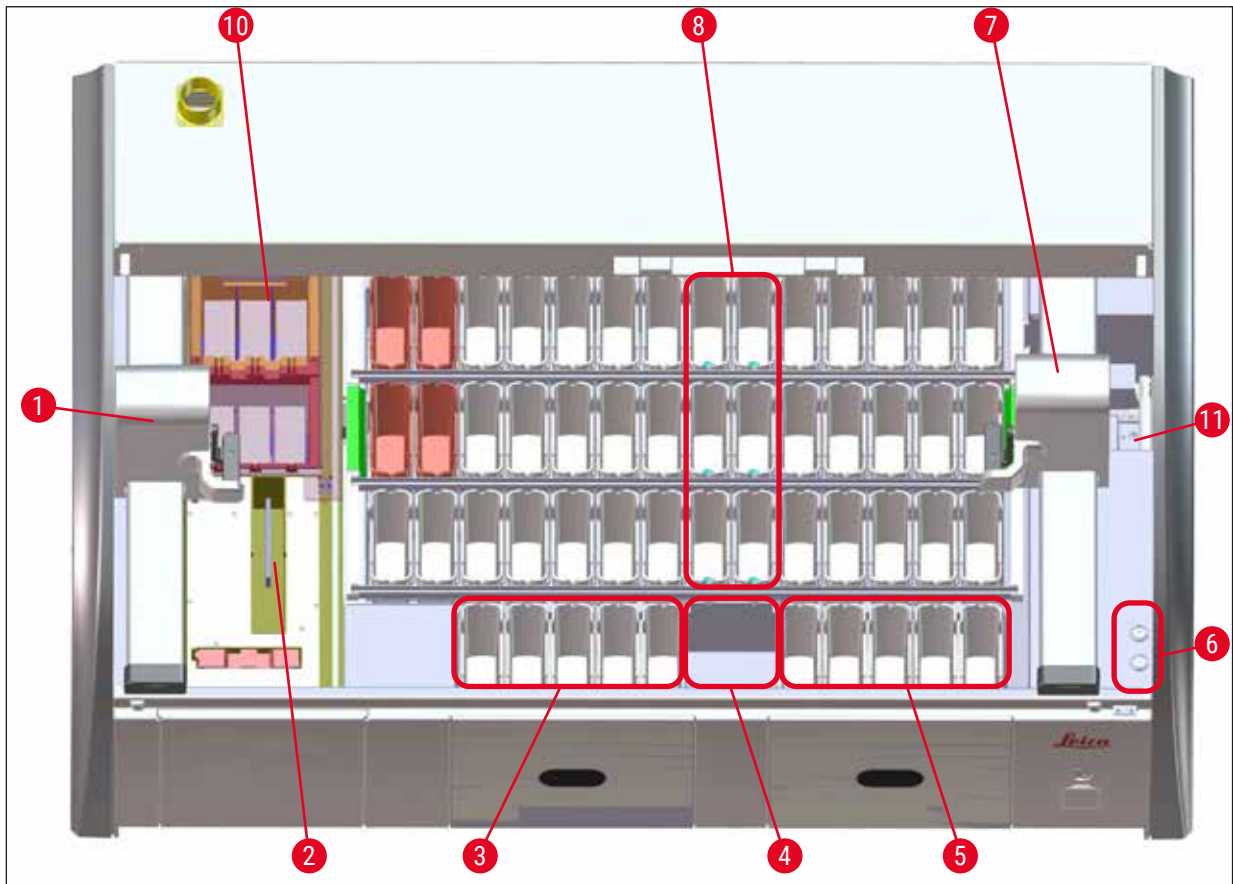

Fig. 3

- 1 Left transport arm
- 2 Specimen slide counter station
- 3 Load stations, 5 pcs.
- 4 Dry transfer station, 2 pcs.
- 5 Unload stations, 5 pcs.
- 6 Fuse holder, 2 pcs.
- 7 Right transport arm
- 8 Rinsing water stations, 6 pcs.

- 10 Drying oven stations, 6 pcs
- 11 Transfer station to HistoCore SPECTRA CV (optional)



Note

This optional accessory is not available in all regions/countries. Please contact your local Leica sales organization.

4. Installation and Starting Up

4.1 Installation site requirements



Note

- Installation and leveling are carried out as part of the instrument installation by personnel authorized by Leica only!
 - Use 4 qualified persons when lifting the instrument; grab under the frame at all corners and lift evenly.
-
- It must be ensured that there is a mostly vibration-free floor and sufficient clear space (approx. 1.10 m) above the laboratory bench to allow unobstructed opening of the hood.
 - It is the user's responsibility to make sure that a compatible electromagnetic environment is maintained so that the instrument can work as intended.
 - Condensation water may form in the instrument if there is an extreme difference in temperature between the storage location and the installation site and if air humidity is high at the same time. A waiting time of at least two hours must be observed each time before switching on. Failure to comply with this may cause damage to the instrument.
 - Stable, exactly horizontal and level laboratory bench at least 1.40 m wide and 0.80 m deep.
 - The counter area must be vibration-free and level.
 - Fume hood at a max. 2.0 m distance from the instrument.
 - The instrument is suitable for operation in indoor areas only.
 - The operating location must be well-ventilated. In addition, an external exhaust air extraction system is highly recommended.
 - A rinsing water connection must be available at a maximum distance of 2.5 m. This connection must also be easily accessible after installing the instrument.
 - A waste water connection must be available at a maximum distance of 2 m. This connection must be connected to the instrument with a constant outlet hose slope down and away from the instrument.
 - The power plug must be freely and easily accessible.



Warning

- A connection to an external exhaust system (highly recommended), a technical room ventilation system and an integrated exhaust system with an active carbon filter reduce the concentration of solvent vapor in the room air. The active carbon filters must be used for connecting to an external exhaust system as well. Compliance with this is mandatory.
 - The instrument operator bears responsibility for complying with workplace limits and the measures necessary for this, including documentation.
-
- A **GROUNDING POWER SUPPLY SOCKET** must be available at a maximum distance of 3 m.

4 Installation and Starting Up

4.2 Rinsing water connection



Note

- There is the option of choosing between two connection variants (→ P. 29 – 4.2.1 Joint connection of all 6 rinsing water stations). The instrument must be programmed to the connection variant used (→ P. 96 – Fig. 74).

The following installation instructions apply for both types of connections:

- Take the rinsing water supply hose (→ "Fig. 4-1") out of the packaging.
- The connection for the water supply is straight (→ "Fig. 4-3"), the connection for the instrument side is angled (→ "Fig. 4-4").
- Check whether the sealing rings (→ "Fig. 4-2") are attached to the connection for the water supply (→ "Fig. 4-3") and to the connection for the instrument side (→ "Fig. 4-4").



Warning

The hose cannot be connected if the sealing rings are missing! In this case, contact the responsible Leica service organization.

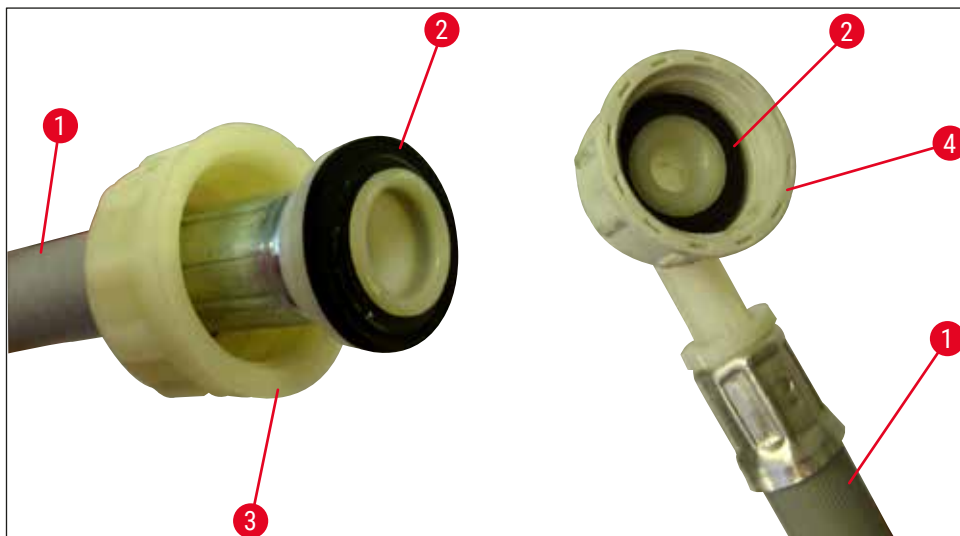

Fig. 4



Warning

Regardless of the selected connection variant (6 rinsing water stations or 4 rinsing water stations and 2 deionized/demineralized water stations), both supply hoses have to be always connected to the instrument.

Shut off the water supply during pauses in use of the instrument and when the instrument is shut down.

4.2.1 Joint connection of all 6 rinsing water stations

If all the rinsing water vessels (6 rinsing water stations) are to be connected to a shared rinsing water connection, both supply hoses (→ "Fig. 5") are to be used in the manner shown. Both running water connections are (→ "Fig. 5-4") connected to a single water tap (→ "Fig. 5-8") using a Y-piece:

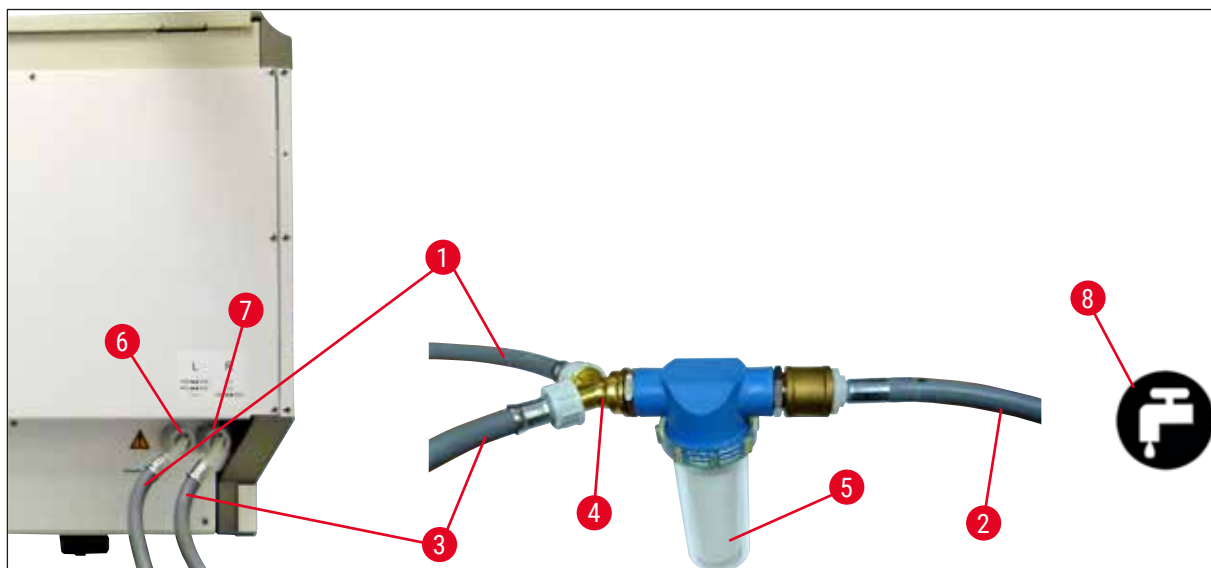

Fig. 5

- | | | |
|---|--|--------------------------|
| 1 | Water inlet hose 1 (2.5 m) | Order No.: 14 0474 32325 |
| 2 | Extension hose, 1.5 m | Order No.: 14 0512 49334 |
| 3 | Water inlet hose 2 (2.5 m) | Order No.: 14 0474 32325 |
| 4 | Y-junction | Order No.: 14 3000 00351 |
| 5 | Filter housing | Order No.: 14 0512 49331 |
| 6 | Rinsing water connection (group of 4) | |
| 7 | Distilled water or rinsing water connection (group of 2) | |
| 8 | Rinsing water connection in the lab | |

4 Installation and Starting Up

4.2.2 Combined connection 4+2 rinsing water stations

If the main connection (4 rinsing water stations) is to be connected to fresh water and the secondary connection (2 rinsing water stations) is to be connected to a supply in the laboratory with distilled water or desalinated water (demineralized water), proceed in accordance with the following connection diagram:

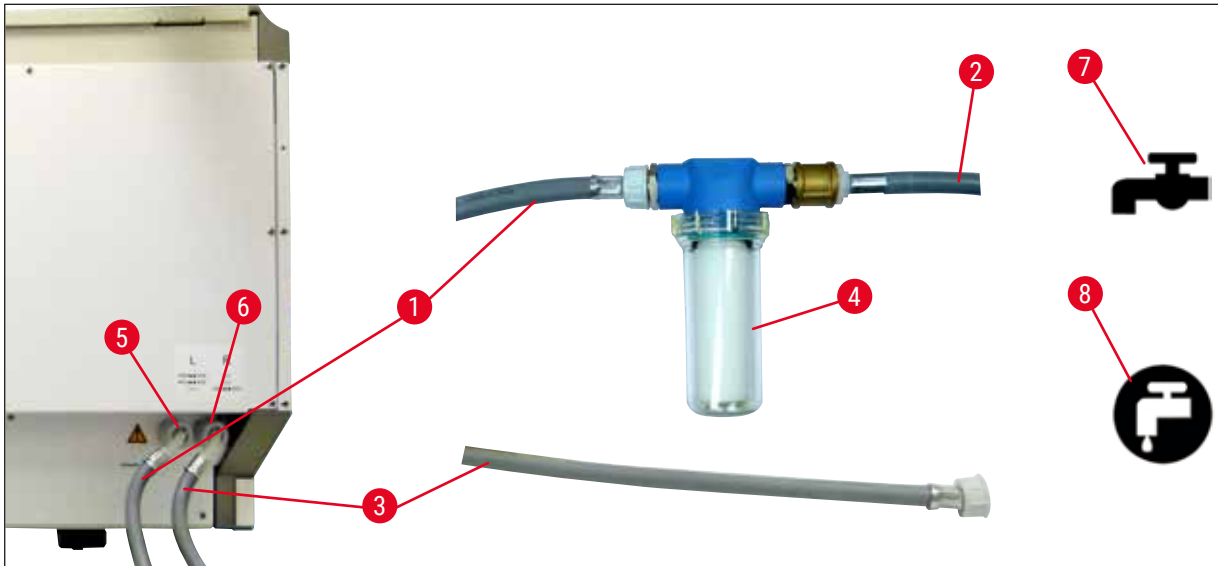

Fig. 6

- | | | |
|---|---|--------------------------|
| 1 | Water inlet hose 1 (2.5 m) | Order No.: 14 0474 32325 |
| 2 | Extension hose, 1.5 m | Order No.: 14 0512 49334 |
| 3 | Water inlet hose 2 (2.5 m) | Order No.: 14 0474 32325 |
| 4 | Filter housing | Order No.: 14 0512 49331 |
| 5 | Rinsing water connection (group of 4) | |
| 6 | Distilled water or rinsing water connection (group of 2) | |
| 7 | Rinsing water connection in the lab | |
| 8 | Distilled water/demineralized water connection in the lab | |



Warning

It is imperative that you observe the correct supply hose connection (→ "Fig. 2-8")!

4.2.3 Wastewater connection



Note

The instrument has a passive wastewater outflow. The lab outflow siphon must therefore be located at least 50 cm below the wastewater connection of the instrument.



Warning

The outlet hose (→ "Fig. 7-1") must be routed at a constant slope and must not be elevated.

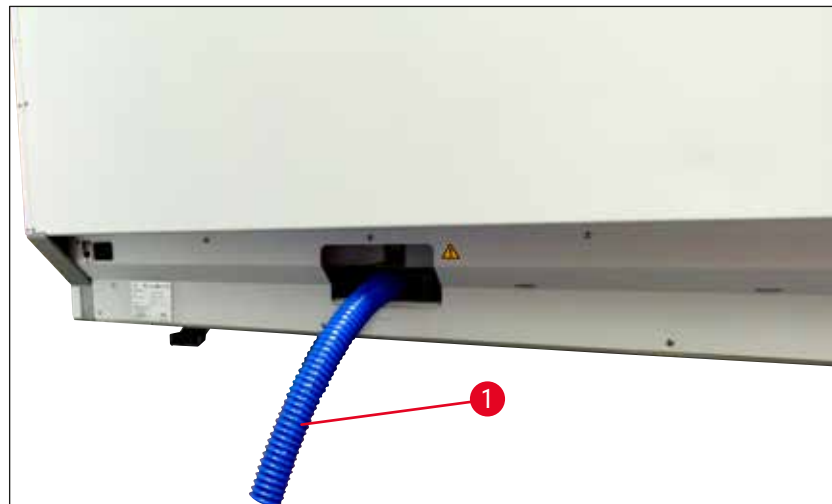

Fig. 7

4.3 Electrical connection



Warning

- Use only the power cord provided, which is intended for the local power supply.
- Before connecting the power plug to the power supply, make sure that the **power switch** on the front right side of the instrument is in the **OFF** ("0") position.

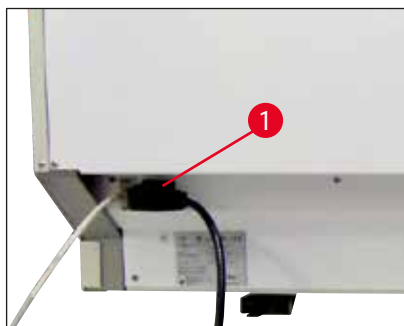

Fig. 8

- Connect the power cord to the power input socket on the rear panel of the instrument (→ "Fig. 8-1").
- Plug the power plug into a grounded power socket.

4 Installation and Starting Up

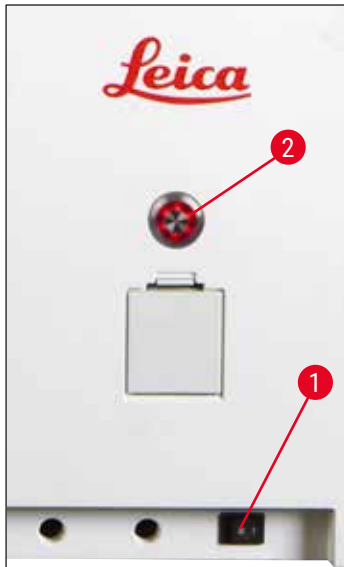

Fig. 9

- Switch on the **power switch** (→ "Fig. 9-1").
- After a short period of time, the **operating switch** lights up orange. Once the software has finished starting up, the switch lights up red (→ "Fig. 9-2") and the instrument is in **standby** mode.
- The **operating switch** can then be operated (→ P. 33 – 4.5 Switching the instrument on and off).

4.3.1 Using an external uninterruptible power supply (UPS)

An interruption of the staining process can be avoided in the event of a temporary power failure by connecting a battery-buffered uninterruptible power supply (→ "Fig. 10-1") (UPS). The UPS should enable an output of at least 1580 VA for the duration of 10 minutes. The UPS must be designed for operating voltage at the installation location. The connection is carried out by connecting the HistoCore SPECTRA ST power cord to the UPS power output socket. The UPS is connected to the power socket in the lab.

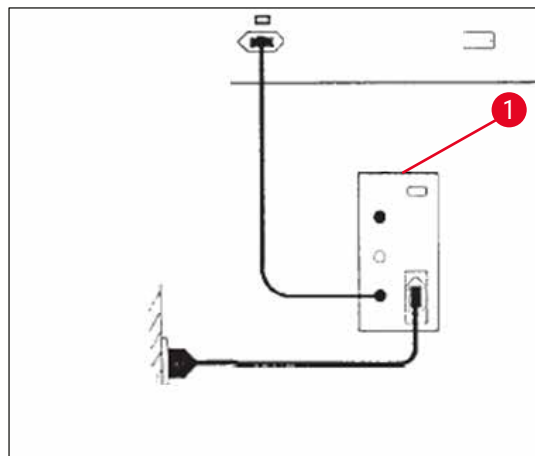

Fig. 10



Warning

The UPS power cord must always remain in the power socket in the lab, even in the event of a power outage. Otherwise grounding of the instrument cannot be ensured!

4.4 Exhaust air connection

- » Connect one end of the exhaust air hose (→ "Fig. 11-1") to the exhaust port (→ "Fig. 11-2") on the top side of the instrument. Connect the other end to an exhaust air device installed in the lab.

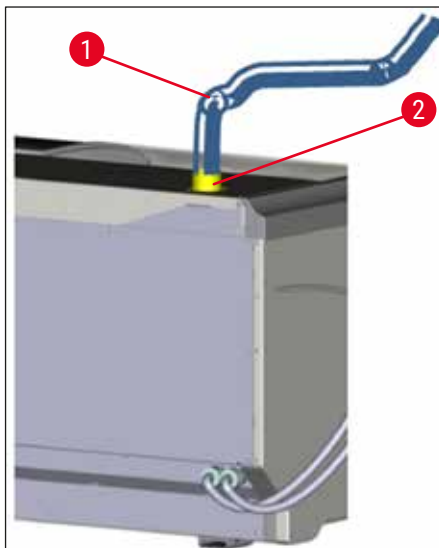

Fig. 11



Warning

- A connection to an external exhaust air extraction system (highly recommended) and an integrated exhaust system with an active carbon filter reduce the concentration of solvent in the room air and must be used. The vessels must be covered when not using the instrument to prevent the unnecessary evaporation of the reagents.
- The owner/operator must verify compliance with the workplace limit values when work is done with hazardous materials.

4.5 Switching the instrument on and off



Warning

The instrument must be connected to a grounded power socket. For additional electrical fuse protection, connecting the HistoCore SPECTRA ST to a socket with a residual current circuit breaker (RCCB) is recommended.

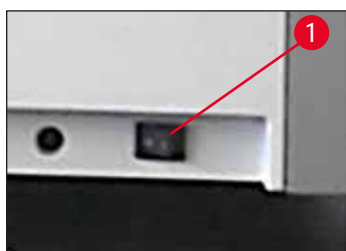

Fig. 12

- Switch the **power switch** on the front right side at the bottom of the instrument to **ON** ("I") (→ "Fig. 12-1").

4 Installation and Starting Up



Fig. 13

- A few seconds after switching on the **power switch**, the **operating switch** is illuminated in orange (→ "Fig. 13"). The software's start process ends when the **operating switch** illuminated in red.



Note

Pressing the **operating switch** in the orange phase does not start the instrument.



Fig. 14

- To start the instrument, press the red flashing **operating switch** (→ "Fig. 13"); an acoustic signal sounds.
- During initialization, a verification of all stations (**fill level scan**) is carried out automatically.
- The **operating switch** is illuminated in green whenever the instrument is ready to start.
- After completing the initialization phase, the **Main menu** (→ "Fig. 14") appears on the screen.

Shutting down the instrument

- To switch the instrument into standby mode (e.g. overnight), press the **operating switch** (→ "Fig. 13") twice. It then illuminates in red.
- For cleaning and maintenance, also shut down the instrument at the **power switch** (→ "Fig. 12-1").



Note

During the instrument setup or if no reagents have been added, non-filled stations are identified and highlighted on the screen (→ P. 92 – 6.2.2 Automatic fill level scan).



Warning

If an oven step is programmed as the first step of the staining program, the program can be marked "not startable" after switching on the instrument since the oven has not yet reached the operating temperature. As soon as the operating temperature is attained, the program is displayed as startable.

5. Operation

5.1 User interface - overview

The HistoCore SPECTRA ST is programmed and operated via a color touchscreen. The screen appears as follows after switching on if there is no staining process (program) running.

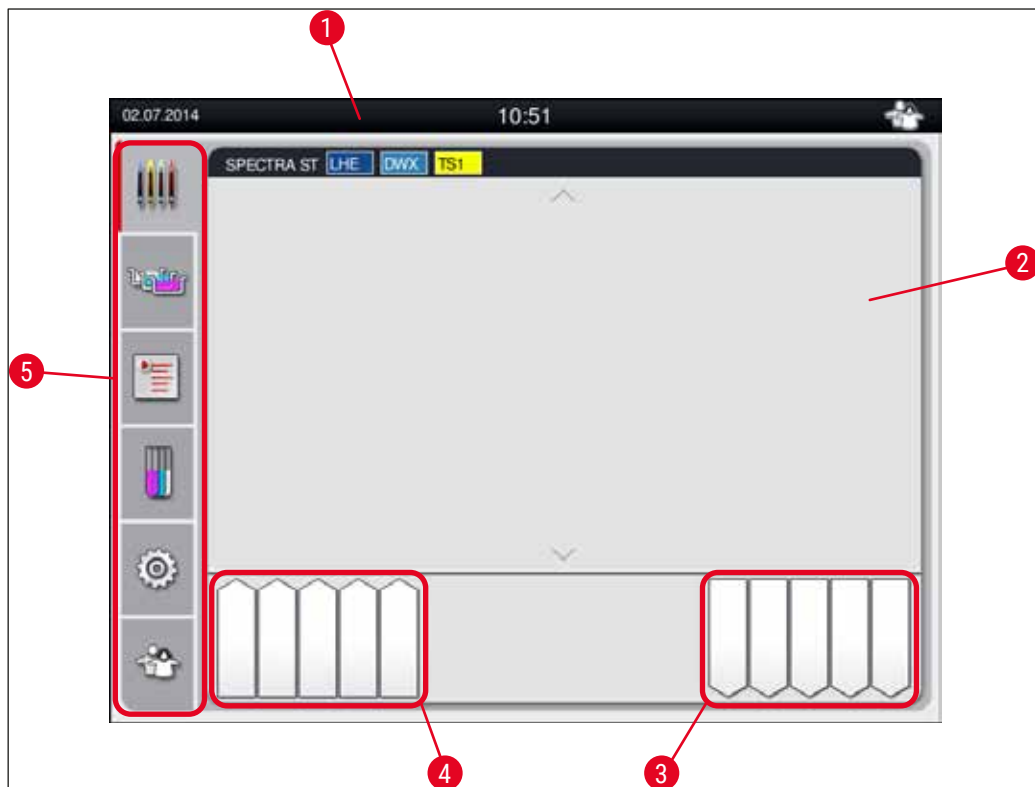

Fig. 15

- 1 Status bar
- 2 Process status display
- 3 Unload drawer status display
- 4 Load drawer status display
- 5 Main menu (→ P. 40 – 5.5 Main menu - overview)

5.2 Elements of the status display

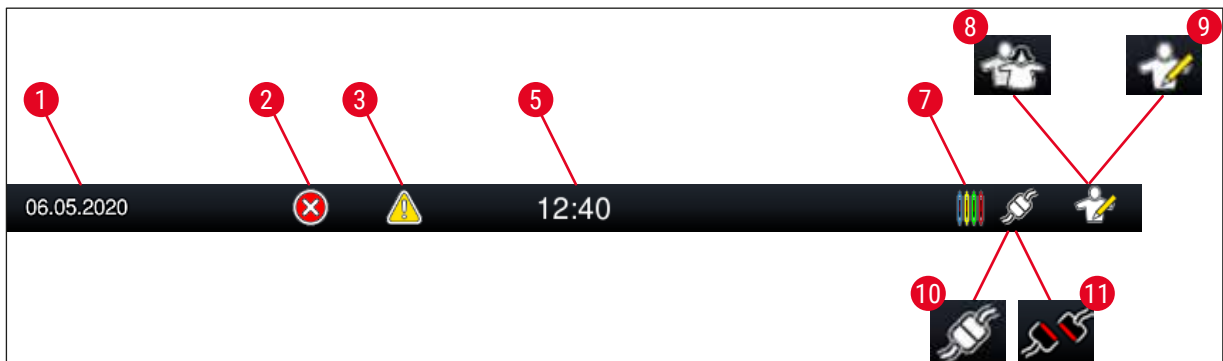

Fig. 16

- 1 Current date
- 2 If alarms and error messages are displayed during operation, this alarm symbol appears. Pressing this symbol allows the last 20 active information messages to be viewed again.
- 3 If warnings and notes are displayed during operation, this notification symbol appears. Pressing this symbol allows the last 20 active information messages to be viewed again.
- 5 Local time
- 7 The "**Process**" symbol indicates that staining processes are currently active and that racks may still be in the unload drawer.
- 8 This "**User**" symbol indicates that the instrument is in user mode, which enables simplified operation of the instrument without a password.
- 9 The operation of this instrument in "**Supervisor Mode**" is displayed by this symbol. This mode provides additional operation and adjustment options for trained staff. Access to this mode is password-protected.
- 10 The connection between the HistoCore SPECTRA ST and the HistoCore SPECTRA CV has been established.
- 11 The connection between the HistoCore SPECTRA ST and the HistoCore SPECTRA CV has been interrupted.

5.3 Process status display

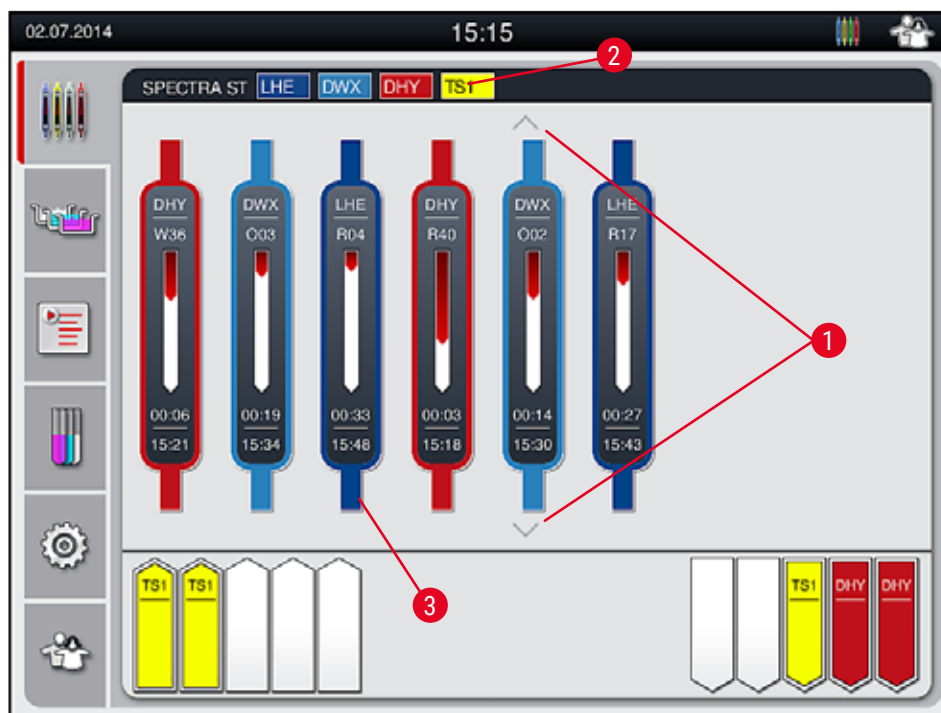

Fig. 17

The main window (→ "Fig. 17") displays all racks (→ "Fig. 17-3") located in the process.



Note

To display an active staining process, the upper part of the handle is displayed symbolically in the respective color (→ "Fig. 17-3"). If the number of racks in the process exceeds the maximum that can be displayed in the main window (max. 9), you can scroll through the display area vertically using the (→ "Fig. 17-1") keys. If one of the buttons is grayed out, it is disabled and there are no other elements in an area that is not shown.

The title bar of the main window (→ "Fig. 17-2") indicates the instrument type [SPECTRA ST] and lists the currently bootable staining programs with the defined abbreviations and the color assigned to the racks.



Warning

- In the Process status display, the availability and the selected number of different unload stations is not visible to the user. It is recommended to use the Bathlayout menu for process monitoring (→ "Fig. 85") when using different reagents in the unload stations in order to be able to react in advance when the unload capacity is reached.
- If finished racks are not removed from the unload stations in due time, this may lead to interruptions in the staining process and may effect the staining results.

5 Operation



Note

Each ongoing staining process is illustrated by a rack handle symbol. It is shown in the same color as the actual rack handle. Various information is displayed on the handle symbol (→ "Fig. 18").

If the HistoCore SPECTRA ST stainer is permanently connected to a HistoCore SPECTRA CV robotic coverslipper, both instruments can be operated as a workstation. This enables continuous workflow from the staining process up to the removal of the finished coverslipped slides. The time of transfer to the HistoCore SPECTRA CV is then also displayed in the process status bar (→ "Fig. 18-6").

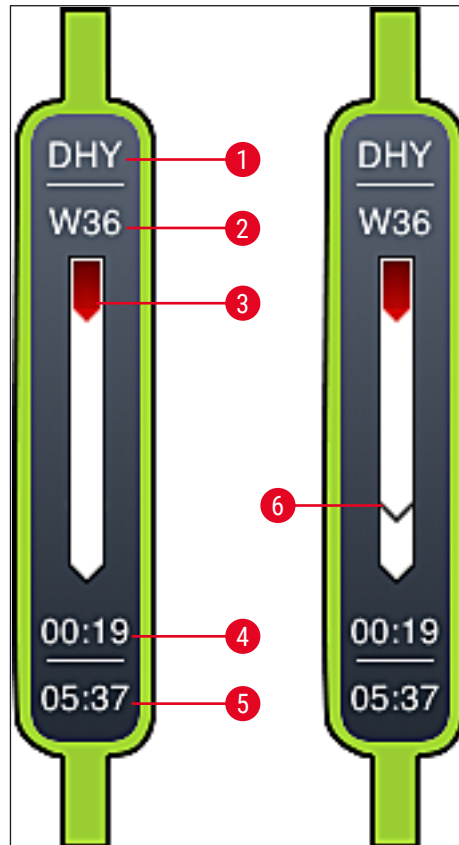

Fig. 18

- 1 Abbreviation of the program name
- 2 Current position of the rack in the instrument
- 3 Progress display of the entire staining process
- 4 Estimated remaining time of the program (hh:mm)
- 5 Real time at the end of the program
- 6 Time of transfer to the robotic coverslipper HistoCore SPECTRA CV during operation as workstation (→ P. 111 – 6.6.5 Operation as a workstation)

5.4 Displaying the drawers

The lower area of the main window illustrates the status of the load and unload drawers.

- The stations displayed with the direction of the arrow pointing into the instrument (→ "Fig. 19-1") symbolize the load drawer and the stations displayed with the direction of the arrow pointing out of the instrument (← "Fig. 19-2") symbolize the unload drawer, each with five positions.
- The calculated starting time (→ "Fig. 19-5") is displayed for each rack in the load drawer.
- The respective drawer is opened or closed automatically by pressing the drawer key (→ "Fig. 19-3") or (→ "Fig. 19-4").
- The instrument automatically recognizes if racks are inserted or removed when the drawer is closed.
- The racks located in the input or unload drawer are shown on the screen with the respective rack handle color and the assigned program abbreviation.
- Available positions are shown in white.



Note

The load and unload drawers can be opened if the drawer button lights up green (→ "Fig. 19-4"). When racks are being transported out of the load drawer or into the unload drawer, the button on the corresponding drawer lights up red (→ "Fig. 19-3") and the drawer cannot be opened.

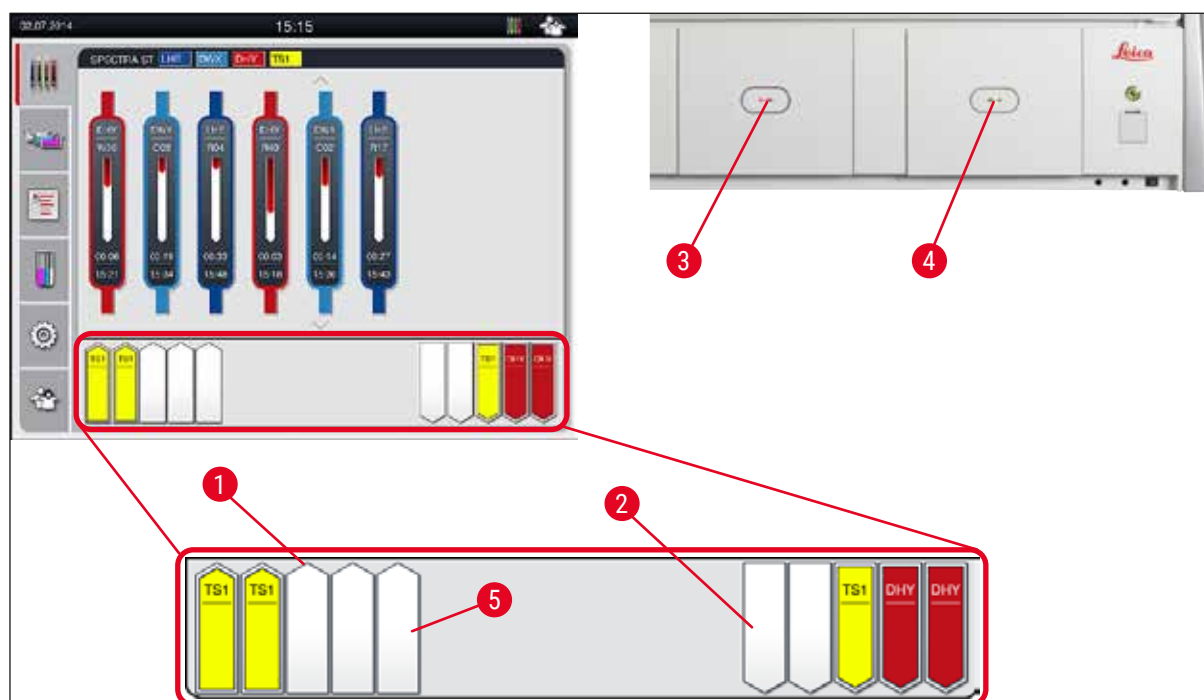

Fig. 19



Warning

Exercise caution when opening or closing the drawers. Crushing hazard! The drawers are motorized and open automatically when the button is pressed. Do not block the extension range of the drawers.

5.5 Main menu - overview

The main menu is located on the left side of the display (→ "Fig. 15-5"), which is divided as described below. This menu is visible in all submenus and allows switching to another submenu at any time.



The **Process Status Display** displays the current status of all racks in process. Here, the respective handle of the rack is displayed as a symbol with the respective color.

This display shows the standard display.



The **Bathlayout** displays the top view of all stations within the instrument. The individual reagent stations are displayed with abbreviations of reagent names, station numbers and racks in progress.



After activating the **Program List**, all staining programs available in the instrument are displayed in list format. The menu enables re-entering and changing staining programs, their prioritization and the execution of the bathlayout.



After activating the **Reagent List**, all previously entered reagents are displayed in list format. The menu enables the modification or re-entering of staining reagents, e.g. for integrating new staining programs. The reagents must be entered before creating the program.



Basic settings can be configured in the **Settings** menu. The language version, date and time as well as oven temperature and other parameters can be adjusted to the local requirements here.



In the **User Settings** menu, an individual password can be set up to prevent modifications to the programs and reagent lists by unauthorized persons (**Supervisor Mode**). However, the instrument can be used without a password in **User Mode**.

5.5.1 The keyboard



Note

A keyboard appears (→ "Fig. 20") for required entries (e.g. for creating programs, editing programs, or entering a password). It is operated using the touchscreen.

Note that the keyboard display depends on the configured language.

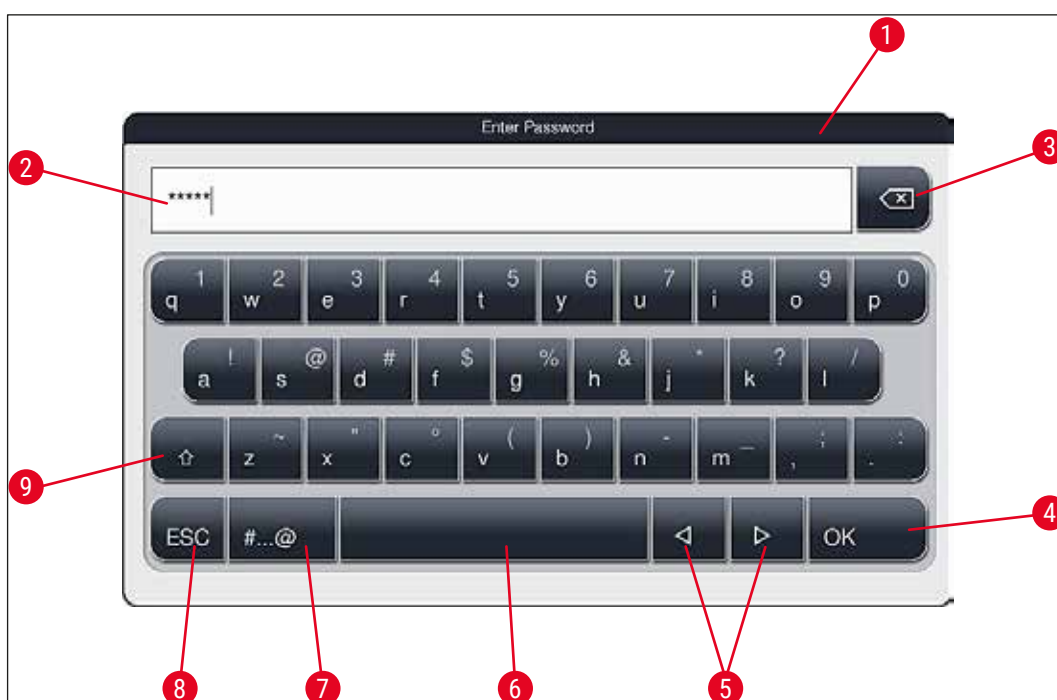

Fig. 20

- 1 Title bar
- 2 Input field
- 3 Delete most recently entered character
- 4 Confirmation
- 5 Move cursor to left or right
- 6 Space key
- 7 Special character shift button (→ "Fig. 21")
- 8 Cancel (entries are not saved!)
- 9 Upper and lowercase (pushing the button twice activates caps lock, indicated by the button turning red. Pressing again re-activates lowercase.)

Special character keyboard



Fig. 21

Other special characters



Fig. 22

- To enter a special character or umlaut, etc. not included in the special character keyboard (→ "Fig. 21"), hold the corresponding normal button on the keyboard.
- Example: Holding the standard **a** button brings up other selection options (→ "Fig. 22").
- Select the required character from the new single-line keyboard by pressing it.



Note

The following lengths are applicable for passwords and designations:

- Reagent names: max. 30 characters / reagent abbreviations: max. 10 characters
- Program names: max. 32 characters / program abbreviations: max. 3 characters
- Passwords: min. 4 to max. 16 characters

5.6 User settings



This menu can be used to configure the appropriate access level. A distinction is made between:

- Standard user
- Supervisor (password-protected)
- Service technician (password-protected)

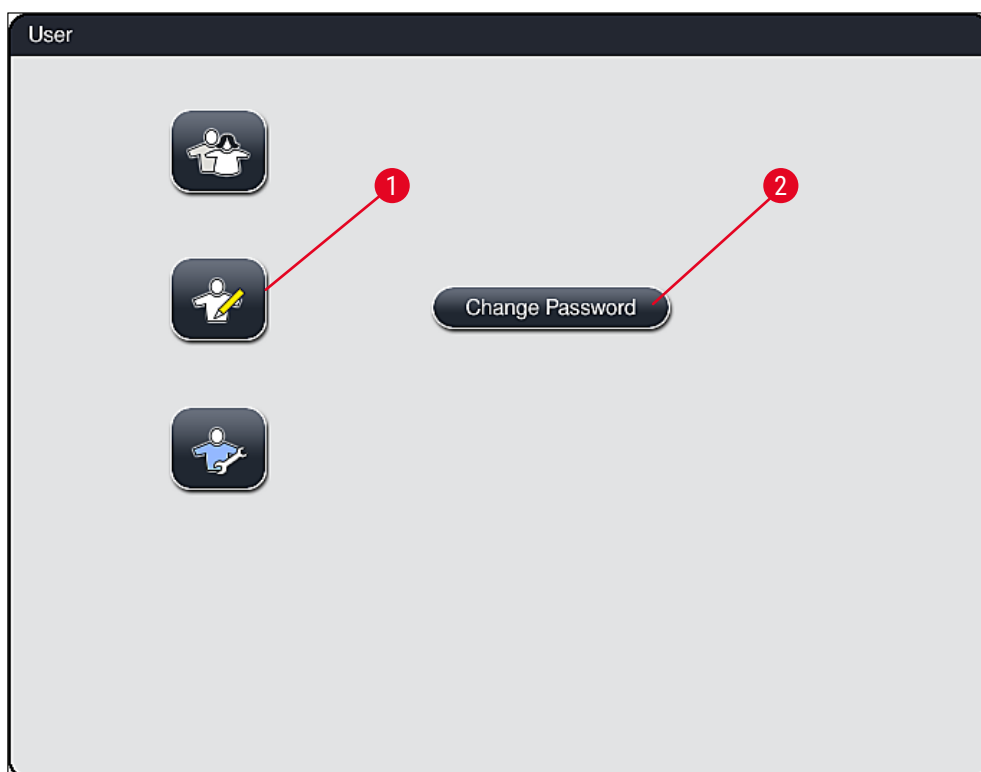

Fig. 23



Standard user:

The standard user does not need a password and can use the completely configured instrument for all routine applications. It is not possible for this user group to modify programs and settings.



Supervisor:

Supervisors have the same access options as the standard user, but can also create programs and perform the instrument setup functions. Therefore, supervisor access is password-protected.



Note

It is recommended to exit **Supervisor Mode** when all desired changes have been made and saved. To log out, press the **Standard User** button from the **User Settings** menu.

5 Operation

To activate supervisor mode, proceed as follows:

1. Press the **Supervisor** button (→ "Fig. 23-1").
2. A keyboard (→ "Fig. 24") is then displayed which can be used to enter the password.
3. Input is finished by confirming with **OK**, and the entered password is checked for validity.
4. The current user status is displayed with the respective symbol in the status bar (→ "Fig. 16") on the top right.



Fig. 24



Note

The password configured at the factory should be changed during the initial setup.

To change the supervisor password, proceed as follows:

1. To change the password, press the **Change Password** button (→ "Fig. 23-2") and enter the old password.
2. Then, enter the new password twice using the keyboard and confirm with **OK**.



Note

A password must have at least 4 characters and may have up to 16 characters.



Service technician:

The service technician can access system files and carry out basic settings and tests.

5.7 Basic settings



Note

Changing some of the settings, for example when setting up the instrument for the first time, is only possible in Supervisor mode (→ P. 44 – To activate supervisor mode, proceed as follows:).

Touching the gear symbol (→ "Fig. 25-1") opens the **Settings** menu (→ "Fig. 25"). Basic instrument and software settings can be configured in this menu.

- Touching a symbol (→ "Fig. 25-2") selects it and highlights it in red.
- The respective settings window is displayed in the right area of the screen.
- The individual submenus are described below.



Fig. 25

5.7.1 Language settings



- The language selection menu is displayed by pressing the symbol for the **Language** (→ "Fig. 25-2"). This menu contains an overview of all languages installed in the instrument and allows the desired display language to be selected.

- Select the desired language and confirm by pressing the **Save** button.
- The screen display, information messages and labels are displayed immediately in the currently configured language.



Note

A supervisor or Leica service technician can add other languages using Import (→ P. 51 – 5.7.7 Data management).

5.7.2 Regional settings



Basic display settings (→ "Fig. 26") can be configured in this menu.

Temperature Unit

- Configure the temperature unit (→ "Fig. 26-1") in Celsius or Fahrenheit. To do so, position the slider at the desired unit.

Time Format

- The time display (→ "Fig. 26-2") can be changed from a 24-hour display to a 12-hour display (a.m. = morning/p.m. = afternoon) using the slider.

Date Format

- Configure the date display (→ "Fig. 26-3") to international, ISO or US format by pressing the corresponding radio button next to the sample format.
- The activated setting is labeled by a red border (→ "Fig. 26-4").
- Pressing the **Save** button saves the settings.

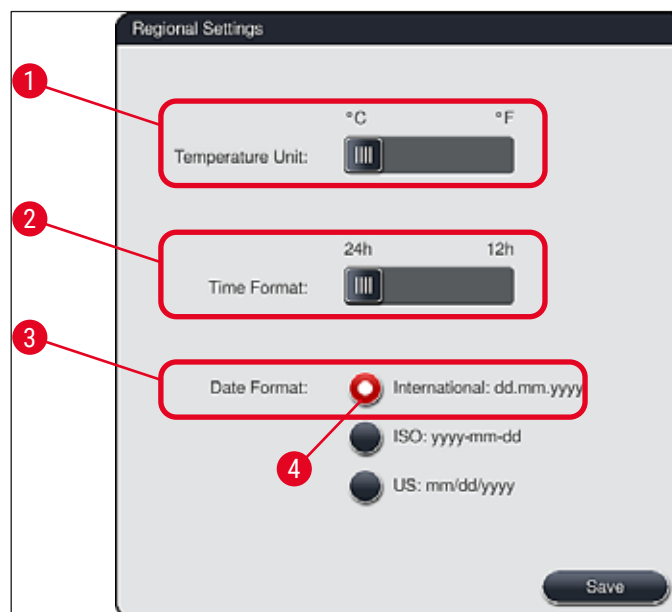
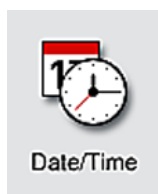

Fig. 26

5.7.3 Date and time



The current date and local time can be configured in this menu (→ "Fig. 27") by rotating the individual rollers.



Note

In the 12-hour display, a.m. (morning) and p.m. (evening) are displayed under the hour digits to enable a correct setting.

The time and date settings cannot deviate more than 24 hours from the system time configured at the factory.

- Pressing the **Save** button saves the settings.



Fig. 27

5.7.4 Menu for alarm tones – Error and signal tones



This menu can be used to select the alarm and signal tones, adjust the volume and check their functionality (→ "Fig. 28-6").

The current setting for alarm and signal tones is displayed after calling up the menu.

5 Operation



Warning

- After starting the instrument, an alarm sound is played. If this does not occur, the instrument may not be operated. This protects the specimens and the user. In this case, contact the responsible Leica service organization.
- The acoustic alarm sounds cannot be disabled. The minimum configurable value for the volume is 2. The maximum value is 9.

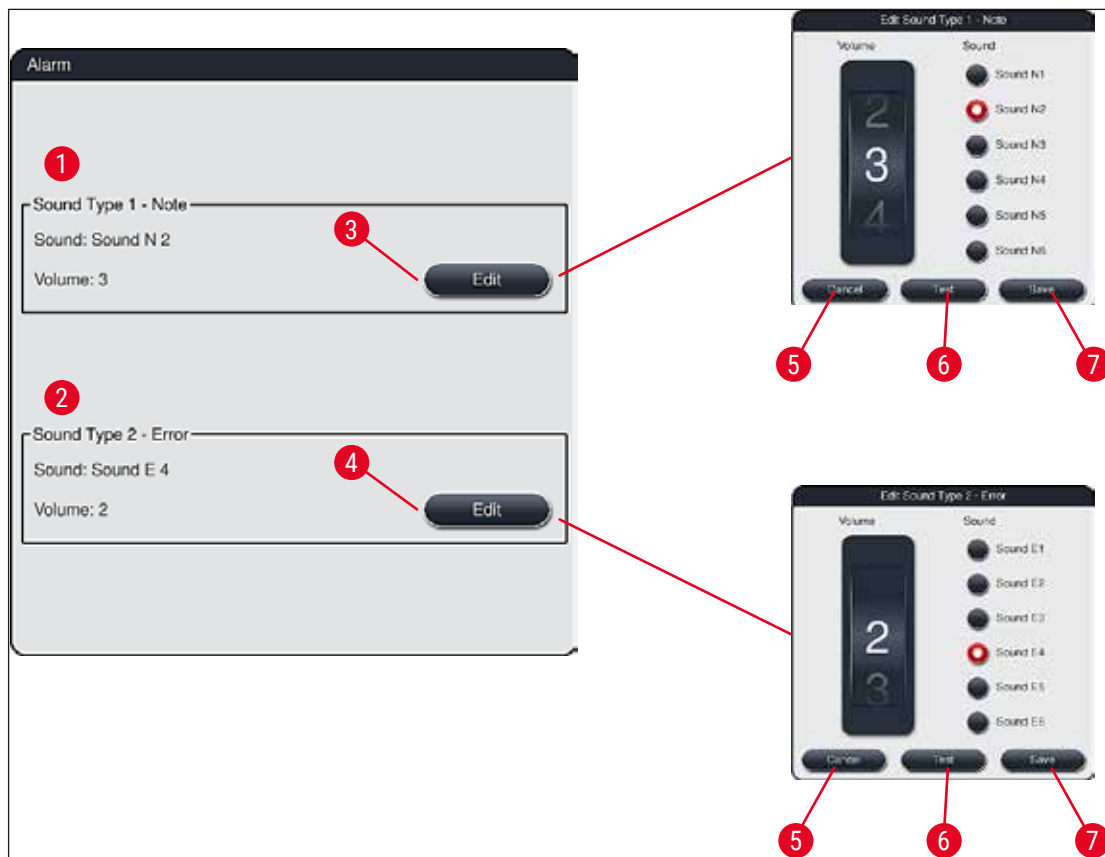

Fig. 28



Sound Type 1 - Note (→ "Fig. 28-1")

Signal tones are issued if warning messages or notifications are displayed on the screen. You can select from a list of 6 sounds. To change the settings, press the **Edit** (→ "Fig. 28-3") button. The volume can be adjusted incrementally by turning the roller (0 to 9).



Sound Type 2 - Error (→ "Fig. 28-2")

Alarm sounds are issued if an error message is displayed on the screen. This requires immediate intervention from the user. You can select from a list of 6 sounds. To change the settings, press the **Edit** (→ "Fig. 28-4") button.

- The volume setting for alarm sounds is adjusted using the **Buzzer volume** roller. Six different sounds are available for the alarm types. The **Test** (→ "Fig. 28-6") button can be used to listen to the respective sound.
- Pressing the **Save** (→ "Fig. 28-7") button saves the settings. The **Cancel** (→ "Fig. 28-5") button is used to close the selection window without applying the settings.

5.7.5 Oven settings

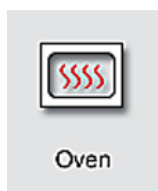

The temperature of the oven and its operating mode can be configured in the menu for the oven settings (→ "Fig. 29"). The current oven settings are displayed after calling up the menu.



Warning

Changing the oven temperature will always have a potential impact on the staining result. An oven temperature that is set too high can have a negative impact on the sample.

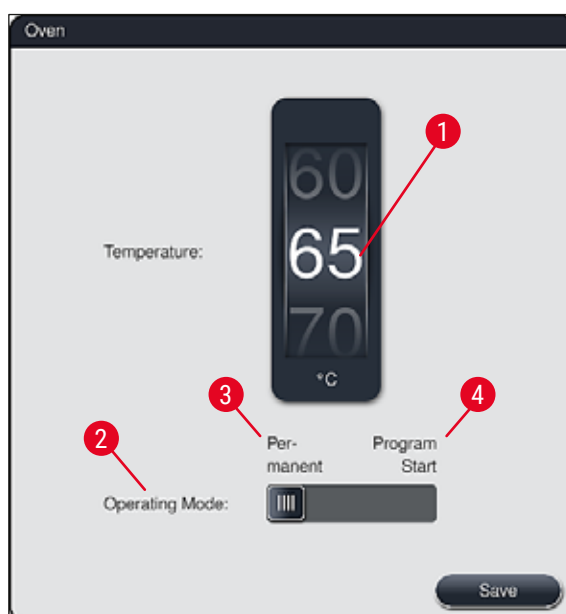

Fig. 29

Temperature:

Turning the roller (→ "Fig. 29-1") sets the target temperature of the oven from 40 °C to 70 °C in increments of 5 °C.

5 Operation

Operating mode:

For the operating mode (→ "Fig. 29-2"), you can choose between:

- Heating the oven when starting a program (→ "Fig. 29-4") (**Program start**) or
- Starting the oven when switching on the instrument (→ "Fig. 29-3")(**Permanent**).
- The slider can be brought to the corresponding position to change the settings.
- Settings are saved by pressing the **Save** button.



Note

- The password-protected operator mode **Supervisor** is required to save the changes. In the simple user mode, the **Save** button is shown in gray and is inactive.
- If Leica staining programs have been integrated into the bathlayout (→ P. 77 – 5.9.9 Executing the bathlayout), the temperature setting cannot be changed. Refer to the information accompanying the Leica reagent kit for the default temperature.



Warning

- We recommend using **Permanent** as a setting to prevent repeated waiting times caused by heating the oven.
- Due to ambient conditions, the set oven temperature can occasionally deviate from the set value by -8 °C to +5 °C. Therefore, the set temperature should be selected accordingly for particularly sensitive specimens (e.g. reducing the set temperature by 5 °C and prolonging the oven step accordingly).

5.7.6 Movement speed - up/down movement (agitation)



In the **Agitation** menu (→ "Fig. 30"), the speed of up/down movement of the holding frame for the rack is adjusted. The rack handles lie on the holding frame which moves up and down in the staining process (agitation).

The current setting is displayed after calling up the menu.



Note

Agitation helps stir the added reagents during ongoing staining processes. The password-protected **Supervisor** user mode is necessary for adjusting the movement speed (agitation).

Speed:

Rotating the **Speed** (→ "Fig. 30-1") roller can be used to configure the agitation frequency in 5 steps (0= agitation disabled, 5= maximum speed). Higher values mean a higher agitation frequency.

Settings are saved by pressing the **Save** button.



Note

- The agitation speed for user-defined programs can only be changed if no validated Leica program is active. In this case, the roller is displayed in black and active.
- The agitation is preset (fixed) for validated Leica programs (see Leica Reagents kit instructions for use). The roller is grayed out and inactive.

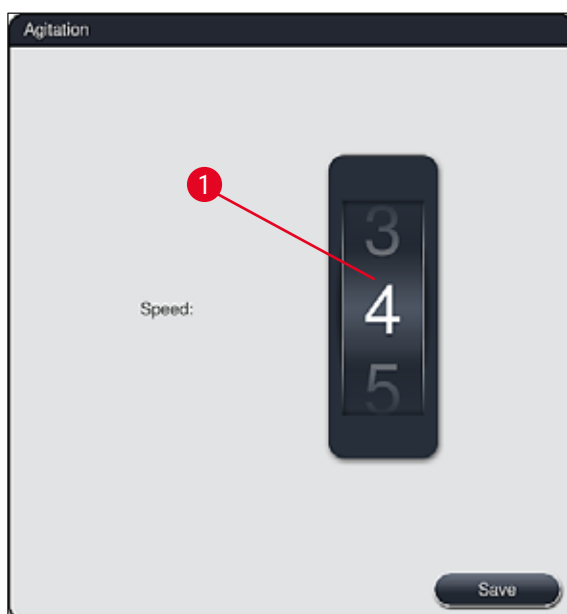

Fig. 30

5.7.7 Data management



In the **Data management** menu (→ "Fig. 31"), the data, settings and event logs (log files) can be exported and imported. A USB memory stick connected to one of the USB sockets on the front side of the instrument (→ "Fig. 1-7") is required for all exports and imports (except for remote software updates).



Note

The USB memory stick used must be formatted as FAT32.

User export (→ "Fig. 31-1")

The **User Export** function is used to save information on a connected USB memory stick (→ "Fig. 1-7"):

- A **zip** file with the event logs of the last 30 working days and **RMS** information in CSV format
- A PDF file containing all user-defined programs, active programs, user-selected settings of Leica programs, bathlayout and the reagent list.
- An encrypted **lpkg** file that contains all user-defined programs and the reagent list.

5 Operation



Note

The **lpkg** file cannot be opened and viewed by the user.

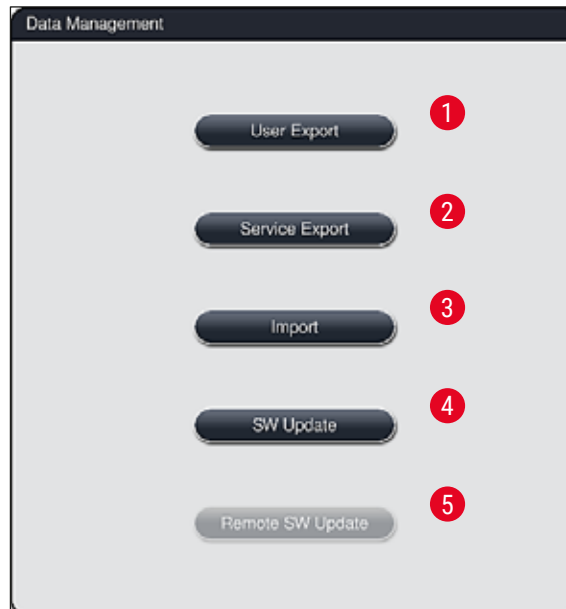

Fig. 31

User-defined programs and the reagent list can be transferred to another HistoCore SPECTRA ST with the identical configuration via the **Import** (→ "Fig. 31-3") function.

- The information message **User data is being exported...** is displayed during the data export.
- The information message **Export successful** indicates to the user that the data transfer is finished and the USB memory stick can be removed safely.
- If the information message **Export failed** is displayed, an error has occurred (e.g. the USB memory stick has been removed too soon). In this case, the export process must be carried out again.



Note

After successfully setting up the instrument, we recommend exporting the data to be able to access it if the instrument has to be set up again.

Service export (→ "Fig. 31-2")

The **Service Export** function is used to save a **lpkg** file on a connected USB memory stick (→ "Fig. 1-7"):

The encrypted **lpkg** file contains a predefined number of event logs as well as the following:

- **RMS** information
- Reagent data
- User-defined program names
- Additional service-relevant data

**Note**

The **lpkg** file cannot be opened and viewed by the user.

- After pressing the **Service export** button, a selection menu appears in which the user can select the desired number of data records to be exported (5, 10, 15 or 30 days).
- Press **OK** to confirm the selection.
- The information message **Service data is being exported...** is displayed for the duration of the data export.
- The information message **Export successful** indicates to the user that the data transfer is finished and the USB memory stick can be removed safely.
- If the information message **Export failed** is displayed, an error has occurred (e.g. the USB memory stick has been removed too soon). In this case, the export process must be carried out again.

Import (→ "Fig. 31-3")**Note**

- The password-protected user mode **Supervisor** is required for importing.
- If one or more files are present in the selection dialog, you can use the file name to assign the save date and instrument serial number. Select the file you want to import and press **OK** in the subsequent information message on the screen.
- The instrument software makes sure that no existing Leica programs and reagents are overwritten during an import of data (programs and reagents). Redundant abbreviations for programs and reagents, as well as redundant reagent names, are automatically replaced by a placeholder or a placeholder is added to them. In the case of redundant specimen slide handle colors, the color of the imported program is set to white.

Specimen slide handle color:

- If a program is imported whose specimen slide handle color already has an assigned program, this color is replaced with white when imported.

Program name abbreviation:

- If a program is to be imported which has an abbreviation that is already used for an existing program, the software automatically replaces this abbreviation with a placeholder. The written-out program name remains the same.
- Abbreviation of the existing program: PAS
- Changed abbreviation of the imported program: +01

Reagent name and reagent name abbreviation:

- If a reagent is imported which has a name and/or abbreviation that is already in use, the software automatically adds a placeholder ("_?").
- Existing reagent name: 100 % Alcohol Dehyd 1 S
- Changed reagent name of the imported reagent: 100 % Alcohol Dehyd 1 S_?
- Existing abbreviation: 100Dhy 1S
- Changed abbreviation of the imported reagent: 100Dhy 1+01

Imported programs and reagents can be integrated into the bathlayout even with placeholders.

They can be renamed later.

5 Operation



Warning

When importing data from a USB memory stick, all user-defined programs and reagents previously located on the instrument are overwritten and replaced by the imported data. It is not possible to select individual files for the import! Leica recommends using this function only for importing backups or installing an additional HistoCore SPECTRA ST with the same parameters.

The **Import** function enables the data import of the encrypted program and reagent list, additional validated Leica programs and additional language packages from a connected USB memory stick.

This data can also be used to equip another HistoCore SPECTRA ST with the same data using the Export/Import function.

- To do this, insert the USB memory stick with the previously exported data into one of the USB sockets on the front side of the instrument (→ "Fig. 1-7").
- Then, select the **Import** function. The data is imported.
- An information message confirms the successful import of the data.



Warning

In general, executing a new bathlayout is required when using the **Import** function (and when importing a new Leica staining program). All Leica reagents currently in the instrument will expire and must be replaced by a new, corresponding Leica reagent kit.

SW update (→ "Fig. 31-4")

If software updates and additional language packages are available, these may be run or installed as follows in the **Supervisor** user mode or by a service technician authorized by Leica.

Carrying out a software update

1. Copy the file for a software update onto a USB memory stick formatted with FAT32.
2. Plug the USB memory stick into in one of the two USB slots (→ "Fig. 1-7") on the front of the instrument.
3. Following this, change to the **Data management** menu and click on **SW Update** (→ "Fig. 31-4").
4. The software update is started.

- ✓ An information message notifies the user of a successful update.



Warning

If the update cannot be carried out successfully, this is reported to the user. If the cause is not obvious, please contact a responsible Leica service organization.



Note

Lab-specific settings are not deleted when updating the software for the HistoCore SPECTRA ST. After a SW update, the instrument must be checked for proper operation.

Remote software update (→ "Fig. 31-5")

This function is currently disabled.

5.7.8 Service access

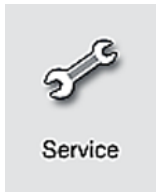

This menu (→ "Fig. 32") gives Leica-authorized service technicians access to technical functions for diagnostics and repairs to the HistoCore SPECTRA ST.

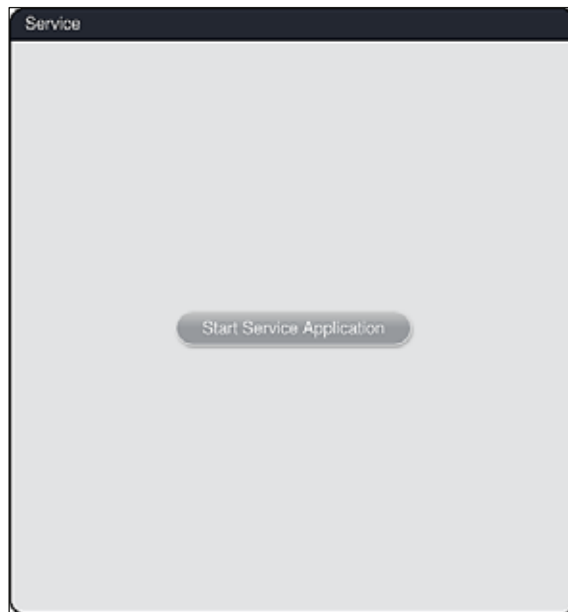

Fig. 32



Note

Access to the service software is locked for all other user groups.

5.7.9 Event viewer

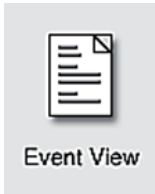

A separate log file is created for each day that the instrument was switched on. This file can be called up by selecting the **DailyRunLog** file in the **Event View** menu (→ "Fig. 33").

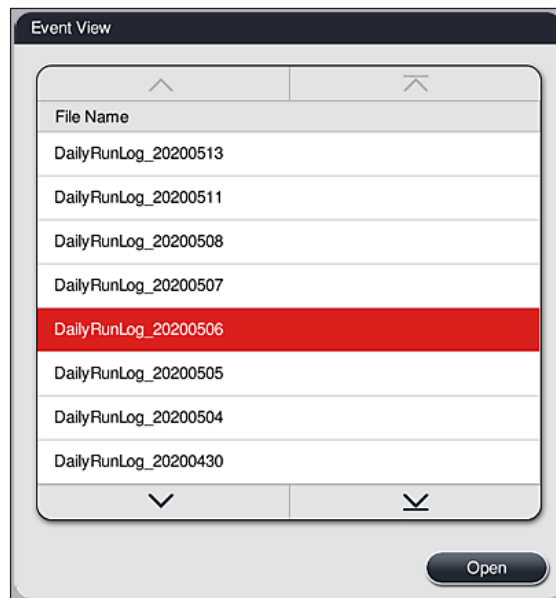

Fig. 33

- In the **Event View** menu, an event log can be selected from a list of available logs and called up by pressing the **Open** button.



Note

The file name is supplemented by adding the respective creation date in ISO format, which makes organization easier. The file is created in the configured language.

- All event entries begin with a time stamp (→ "Fig. 34-1"), which indicates the date and time when the entry was created.
- The title bars of the event viewer also indicate the serial number (→ "Fig. 34-2") and the currently installed software version (→ "Fig. 34-3") of the HistoCore SPECTRA ST.
- You can scroll up and down in the list and the log file using the arrow keys (→ "Fig. 34-4"). Pressing the left button allows you to scroll through the event viewer page by page. Pressing the right button takes you to the beginning or the end of the event viewer.

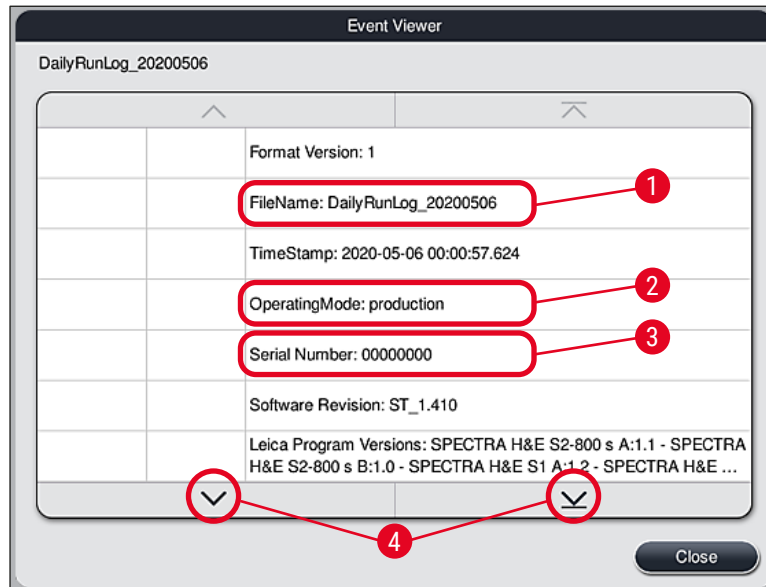

Fig. 34

Entries in the **Event Viewer** are highlighted in different colors to enable the user to quickly identify critical messages. Tapping on an entry in the list will show the specific message on the display.

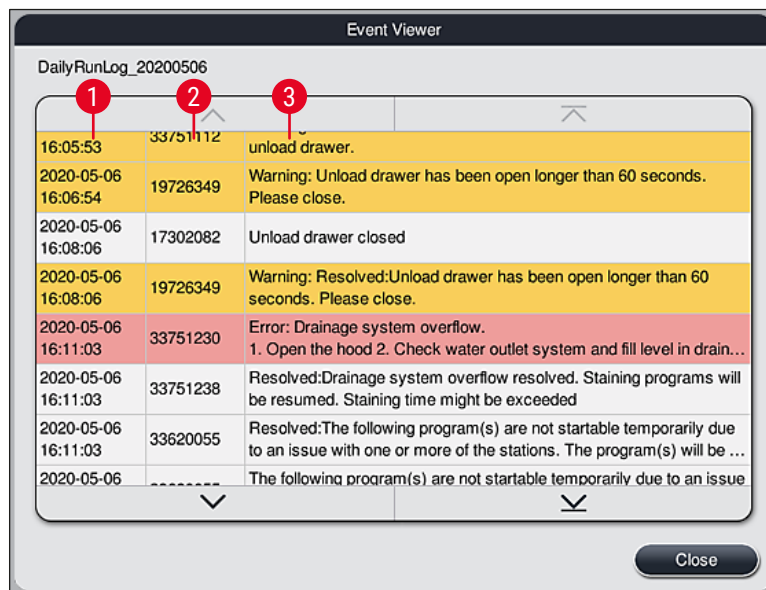

Fig. 35

- 1 Time stamp
 - 2 Event ID
 - 3 Message
- Color: Gray Indicates an event or information
 Color: Orange Indicates a warning message
 Color: Red Indicates an error message

5 Operation

5.8 Reagent list



Open the reagent list by pressing the adjacent button. This displays all defined reagents in alphabetical order.

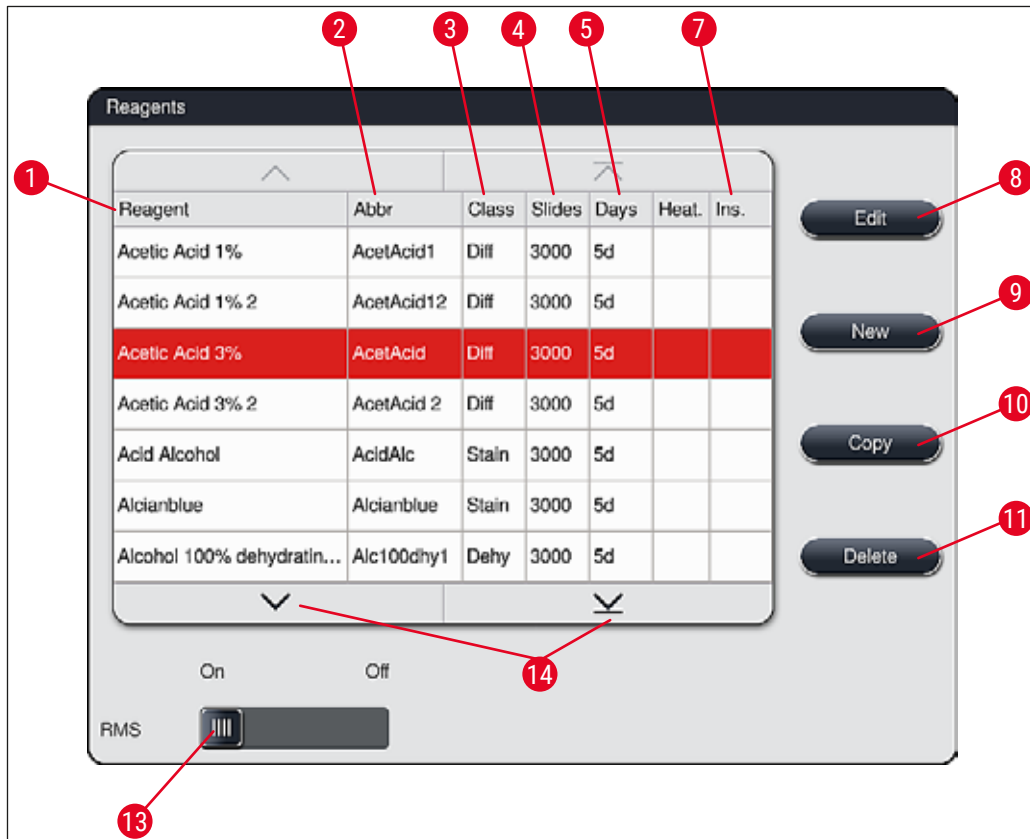

Fig. 36

- | | | | |
|---|------------------------------------|----|---|
| 1 | Reagent name | 8 | Edit selected reagent |
| 2 | Abbreviation of the reagent name | 9 | Create a new reagent |
| 3 | Process class | 10 | Copy selected reagent |
| 4 | Maximum number of specimen slides | 11 | Delete selected reagent |
| 5 | Maximum period of use | | |
| 7 | Insert for special staining yes/no | 13 | Activate/deactivate RMS |
| | | 14 | You can scroll through the reagent list using the arrow keys. |

**Note**

- When setting up the instrument, the reagent list only contains reagents from the preinstalled Leica programs and four predefined unloader reagents (→ P. 70 – 5.9.5 [Creating or copying a new staining program](#)).
- Additional reagents can be added or properties of the reagents can be changed as needed in the reagent list.
- Creating or editing a reagent requires "Supervisor" mode. The **User** status only allows reagent data to be displayed.
- Reagents that have been integrated into the bathlayout in active programs cannot be deleted from the reagent list.

**Warning**

- The **RMS** slide switch: **On – Off** (→ "Fig. 36-13") allows the reagent management system = **RMS** (→ P. 93 – 6.3 [Reagent management system \(RMS\)](#)) to be switched on or off. This system controls reagent consumption monitoring. We always recommend keeping the **RMS** switched on and following the instructions for reagent exchange. It is not possible to switch off reagent monitoring for the Leica staining kit reagents.
- Failure to adhere to the specified intervals can have a negative effect on the staining quality. The **RMS** only works reliably if the data has been correctly stored by the user in advance.
- The manufacturer assumes no liability for the staining results in case of errors when entering the reagent data.
- The **RMS** data of the reagents validated by Leica and their designation cannot be edited by the user.

Creating a new reagent or copying a reagent**Note**

- A new reagent can be created with the **New** (→ "Fig. 36-9") or **Copy** buttons (→ "Fig. 36-10").
- Creating, copying or editing a reagent requires "Supervisor" mode. The **User** status only allows reagent data to be displayed.

- To add a new reagent to the reagent list, press the **New** button (→ "Fig. 36-9").
- It opens the entry window (→ "Fig. 39") for the new reagent to be created.



Fig. 39

The following parameters can be entered:

- Reagent name:** • Press the **Reagent name** (→ "Fig. 39-1") button and use the on-screen keyboard to enter a unique reagent name that has not yet been used. You can enter up to 30 characters (including spaces).
- Abbreviation:** • Press the **Abbreviation** button (→ "Fig. 39-2") to use the on-screen keyboard to enter a unique abbreviation for the reagent that has not yet been used (maximum 10 characters, including spaces).
- Slides max:** • The roller (→ "Fig. 39-3") is used to configure the maximum number of specimen slides that can be processed with this reagent before a reagent change is requested. By rotating the rollers, values between 1 through 3999 are permitted.
- Days max:** • The maximum number of days (→ "Fig. 39-4") that the reagent can remain in the instrument is configured by rotating the roller. Values from 1 through 99 are permitted when entering figures.
- Insert:** • If a reagent vessel is equipped with an insert for special staining (→ P. 90 – 6.2.1 Preparation and handling of reagent vessels) in order to enable a smaller reagent volume, using the rack is only possible for 5 slides in this vessel. For this purpose, you must set the slide switch to **Yes** (→ "Fig. 39-5").
- Using a rack for 30 slides in this vessel is now disabled.

**Warning**

Using the insert for special stainings in one or more reagent vessel(s) requires switching to the **Yes** position. If the switch is not set correctly for the affected reagent vessel(s), this may cause a rack for 30 slides to be used in this vessel, which inevitably leads to a serious equipment failure with possible specimen loss.

- Process class:**
- Assigning the reagents to process classes (→ "Fig. 39-6") (→ P. 62 – 5.8.3 **Process classes**) is required since, along with prioritizing programs, it is essential for automatically calculating the individual positions of the bathlayout (→ P. 76 – 5.9.8 **Prioritizing programs for executing the bathlayout**).
 - Store the entries with the **Save** button (→ "Fig. 39-7") or close the entry window with the **Cancel** button (→ "Fig. 39-8") without applying the entries.

**Note**

Subsequently changing a process class is no longer possible after the initial save. The reagent can only be deleted and re-created or copied and then changed.

5.8.1 Copying a reagent**Note**

If a reagent with different parameters is used in HistoCore SPECTRA ST, then an existing reagent can be copied.

- Select the reagent to be copied in the reagent list (→ "Fig. 36") by tapping it and press the **Copy** (→ "Fig. 36-10") button.
- It opens the entry window (→ "Fig. 39") for the new reagent to be created.
- Apply the suggested reagent name or overwrite it with a new reagent name.
- The suggested abbreviation can be applied or overwritten with a new abbreviation.
- If necessary, change the parameters for the reagent accordingly or apply the existing parameters.
- Store the entries with the **Save** button (→ "Fig. 39-7") or close the entry window with the **Cancel** button (→ "Fig. 39-8") without applying the entries.

5.8.2 Changing the RMS data for a reagent**Note**

If changes are to be made to the **RMS** data (**Slides max** and/or **Days max**), the following steps must be carried out so that modified settings are displayed correctly in the station details (→ P. 99 – Fig. 76).

- Select the reagent to be changed in the reagent list (→ "Fig. 36") by tapping it and press the **Edit** (→ "Fig. 36-8") button.
- Using the rollers, set the new values for the **Slides max** (→ "Fig. 39-3") and/or **Days max** (→ "Fig. 39-4") and apply the changes using the **Save** button.
- Note the following information message and confirm with **OK**.
- Then call up the bathlayout and tap the associated reagent station there to select the station by touching the screen.
- In the station details that appear, press the **Update Reagent** (→ "Fig. 76-10") button.
- The display with the station details is closed, and the **RMS** data has been applied.

5 Operation

5.8.3 Process classes



Warning

Process classes must be assigned correctly since otherwise there is a risk of delayed work flows in the staining processes and deviating or inadequate staining results.

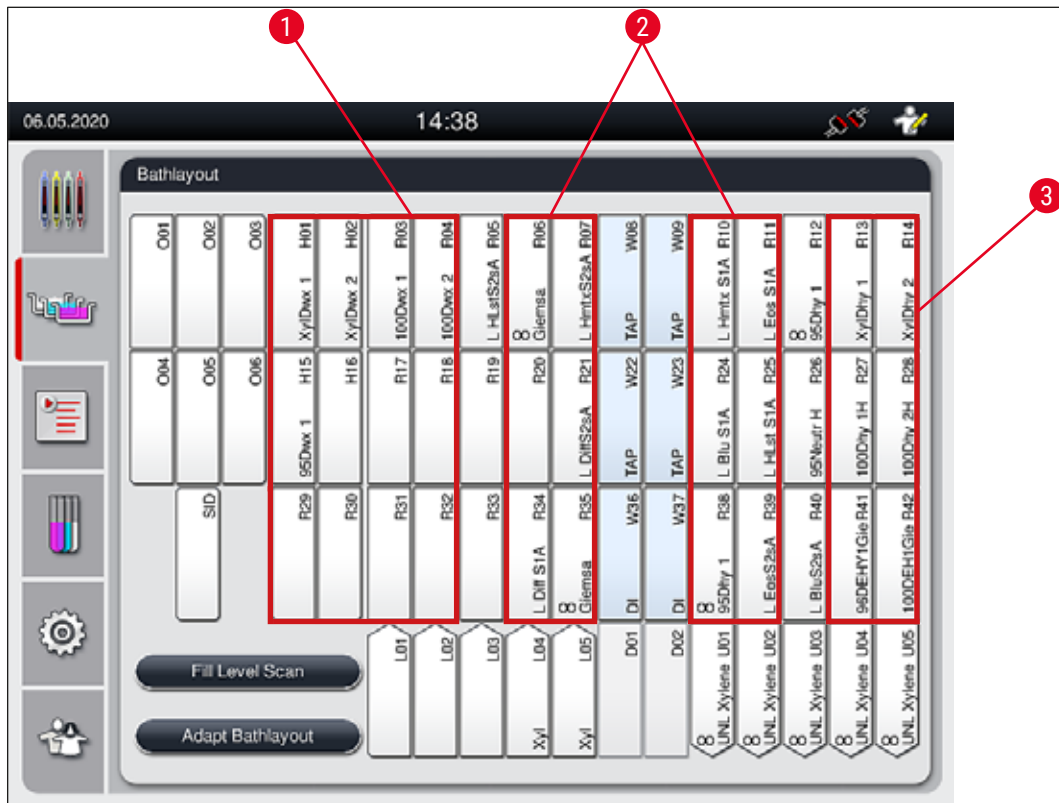

Fig. 40

- 1 The preferred zone for dewaxing reagents is the left side of the bathlayout.
- 2 The preferred zone for staining solutions or differentiating solutions are the two rows to the left and right of the rinsing water stations.
- 3 The preferred zone for dehydrating reagents is the right side of the bathlayout.



Note

No two successive rinsing water steps can be programmed (rinsing water step for distilled water or vice versa). If the sequence of the program steps is to occur in this way, one of the steps has to be defined as a reagent assigned to a process class (e.g. neutralizing).

Process class	Description	Example of reagents
Dewaxing (Dewaxing)	<ul style="list-style-type: none"> • Solvents that remove the paraffin and, following the paraffin removal, the subsequent graded alcohol series, at the beginning of a staining program. 	<ul style="list-style-type: none"> • Xylene • Xylene substitute • Descending alcohol series: 100 %, 95 %, 70 % alcohol

Process class	Description	Example of reagents
Neutralising (Neutralising)	<ul style="list-style-type: none"> Reagents that have little or no effect on the stain application or the stain development and that have a roughly neutral pH value. Example: Distilled water step before a staining step. 	<ul style="list-style-type: none"> Distilled water (demineralized)/ fresh water (not in rinsing water stations!) Thinners with distilled water Aqueous alcoholic solutions (e.g. 70 % ethanol)
Staining (Staining)	<ul style="list-style-type: none"> Staining solutions Wood stains Oxidizing agents (e.g. periodic acid of the PAS staining) 	<ul style="list-style-type: none"> All staining solutions Wood stains and oxidizing agents
Differentiating (Differentiating)	<ul style="list-style-type: none"> Reagents that remove excess color from the product. Reagents that are required for the stain development or a color change. 	<ul style="list-style-type: none"> HCl solution (alcoholic or aqueous) Acetic acid Ammonia water Scott's tap water Bluing solution Blue Buffer Lithium carbonate Alcohols (various concentrations)
Dehydrating (Dehydrating)	<ul style="list-style-type: none"> Reagents of the ascending alcohol series, at the end of a staining program. Subsequent solvent steps (xylene or xylene substitute), at the end of a staining program, for preparing the coverslipping operation. 	<p>Dehydration:</p> <ul style="list-style-type: none"> Ascending alcohol series: 70 %, 95 %, 100 % alcohol <p>Preparing the coverslipping operation:</p> <ul style="list-style-type: none"> Xylene Xylene substitute
Unloader	<ul style="list-style-type: none"> Reagent that is individually defined by the user as a last program step and can be assigned to an unloading station (e.g. for a xylene substitute and/or a further alcohol etc.). It is recommended to use UNL in the reagent name and abbreviation for easier identification. 	<p>Predefined in Reagent List:</p> <ul style="list-style-type: none"> Alcohol (UNL Alcohol) Xylene (UNL Xylene) Water (UNL Water) Empty (UNL Empty) <p>Additional User defined:</p> <ul style="list-style-type: none"> Xylene substitute and other reagents
No class (no class)	Reagents that do not require any special assignment in the bathlayout	



Warning

The following must be observed for preparing the coverslipping operation:

- The solvent used at the end of the program and in the following processing must be compatible with the mounting medium.

**Note**

The correct assignment of the process classes is necessary so that the optimal bathlayout can be calculated and long transport paths and times can be avoided.

Basic rules of automatic execution of the bathlayout include:

- The transfer from the left vessel field to the right vessel field should occur via a rinsing water station whenever possible.
- Programs that do not contain a rinsing water station as a step use the dry transfer station for this transfer.
- Staining reagents that require a subsequent rinsing water step are positioned adjacent to the rinsing water vessels (→ "Fig. 40").
- Reagents for which **No class** has been assigned as a process class can be set at any position during the automatic execution of the bathlayout.
- Instead of the **No class** assignment, we recommend assigning these reagents to either the **Differentiating** or **Neutralizing** process class so that adjacent stations in the bathlayout can be taken into account for series of program steps.

5.9 Staining programs



The list of the staining programs installed on the HistoCore SPECTRA ST is opened by pressing the **Programs** button.

A distinction is made between two types of staining programs:

- Preinstalled Leica staining programs (→ P. 67 – 5.9.2 Leica staining programs (preinstalled))
- User-defined staining programs (→ P. 70 – 5.9.4 User-defined staining programs)



Fig. 41

- 1 A check in this column means that the program is taken into account in the current bathlayout.
- 2 Assigned program color
- 3 Program abbreviation
- 4 Program name
- 5 Preinstalled Leica program
- 6 Edit program
- 7 Create a new program
- 8 Copy selected program
- 9 Delete selected program
- 10 Assign a color to the selected program
- 11 Define bathlayout

5.9.1 Assigning a rack handle color to a staining program



Note

A rack handle color must be assigned to each program.
The assignment of rack handle colors to programs requires the **Supervisor** user status.

- To assign a rack handle color to a program, tap the corresponding program in the program list (→ "Fig. 41") to select it.

5 Operation

- Pressing the "Color" button (→ "Fig. 41-10") displays a selection field (→ "Fig. 42") that allows assignment of the rack handle color to the selected program.



Fig. 42



Note

All available colors are displayed in (→ "Fig. 42"). If an abbreviation is entered in the color field, this color has already been assigned to a program.

If an already assigned color is selected, a dialog box appears with a confirmation prompt indicating that the existing assignment will be undone. This can be confirmed with **OK** or canceled with **Cancel**.

- Select a color that has not been assigned previously.
- **Save** is used to assign the color and close the dialog.
- **Cancel** is used to close the dialog without applying the changes.



Note

If there are not enough rack handles available in one color, then a rack handle in white, the so-called **WILDCARD** color, can be used.

When inserting a rack with a white handle, a program selection window opens in which a color program activated in the bathlayout has to be assigned to the white handle for this program only.

If the transfer station is defined as the last station in the assigned program, the white rack must also be assigned to a suitable parameter set for the coverslipping process in the HistoCore SPECTRA CV. The user is also prompted to do so by a parameter selection window.

After termination of the selected program, this assignment expires again.

5.9.2 Leica staining programs (preinstalled)

Designation of the reagent kits



Note

In the following section, the HistoCore SPECTRA ST staining systems and programs produced by Leica are simplified in accordance with the user interface and named with the designation of the Leica reagent kit and Leica staining programs.

New Leica staining programs can be obtained from the responsible Leica sales company.



Warning

The instructions for use provided with the Leica reagent kits contains important details regarding the preset values, logs and necessary amendments to the bathlayout, and must therefore be strictly observed. Therefore, the instructions for use must be observed.

To import new Leica staining programs, proceed as described in chapter (→ P. 51 – 5.7.7 Data management). New Leica programs are added to the existing program list (→ P. 64 – 5.9 Staining programs). No data is deleted.

- Leica staining programs are preinstalled at the factory and have had their function and staining properties tested. They ensure consistent staining quality for a specified number of slides.
- Leica staining programs are labeled in the last column with a cursive Leica-*L* (→ "Fig. 41-5").

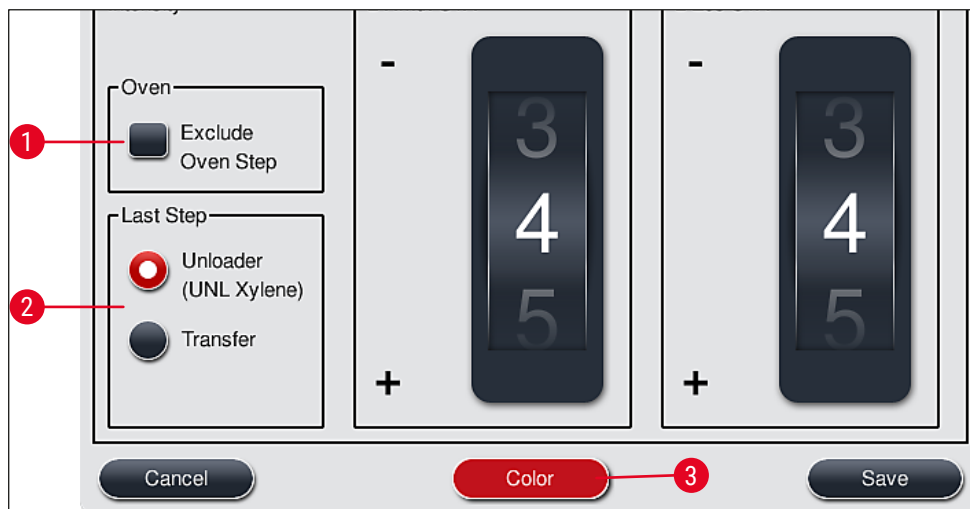

Fig. 43



Note

- Leica staining programs require the use of the specific Leica reagent kit.
- Leica staining programs cannot be copied, meaning that a Leica staining program can only be entered into the program list once.
- The individual program steps of the Leica staining program cannot be shown, edited, copied or deleted.
- A rack handle color (→ "Fig. 43-3") can be assigned to the Leica staining program.
- If the Leica staining program provides for it, the oven step can be enabled or disabled in Supervisor mode (→ "Fig. 43-1"), and the **Unload station** or the **Transfer station** (→ "Fig. 43-2") can be defined as the last step. The **Transfer station** is only displayed if the HistoCore SPECTRA ST is operated with a HistoCore SPECTRA CV as a workstation.
- Reagents (e.g. xylene, alcohol) that are used in a Leica staining program cannot be deleted.



Warning

- If a paraffin removal step is not provided as the first step for the Leica staining program, then the oven step (→ "Fig. 43-1") (→ "Fig. 44-1") must not be enabled, as otherwise the specimens could be destroyed!
- The fixed oven temperature for the Leica staining programs is also used for user-defined staining programs and cannot be individually adapted.

Multiple Installation and use of a Leica staining program



Note

Some Leica staining programs can be used in parallel with different settings (staining intensity, oven step) (→ P. 68 – 5.9.3 Adapting the Leica H&E staining program). These programs are pre-installed twice in the program list (→ "Fig. 41"). To distinguish between these twice pre-installed Leica H&E staining programs, the abbreviations S1A and S1B or S2A and S2B are shown in the program list. These programs contain exactly the same program steps. If two identical programs are integrated into the bathlayout, two identical Leica staining kits must also be scanned and filled.

5.9.3 Adapting the Leica H&E staining program



Note

- With the Leica H&E staining program, the staining intensity can be adjusted for hematoxylin and eosin in Supervisor mode. Other Leica staining programs do not allow for any adjustments to the staining intensities.
- If the Leica staining program provides for it, the oven step can be enabled or disabled (→ "Fig. 44-1").
- For Leica staining programs, the transfer to a connected robotic coverslipper HistoCore SPECTRA CV can be chosen as the last step by selecting **Transfer station** (→ "Fig. 44-4") or by selecting **Unloader** to set the already stained rack into the unload drawer (→ "Fig. 44-3").
- Adjustments and changes to Leica staining programs and user-defined staining programs can only be configured if no staining processes are active and all racks have been removed from the instrument.



Fig. 44

**Warning**

After the user adjusts the staining intensity, the staining results must be checked with a control slide containing representative tissue sections before the settings are used for patient specimens for clinical diagnostics.

Select the Leica program in the program list and press **Edit** (→ "Fig. 41-6"). A dialog window opens in which the settings can be configured.

- The staining intensity values can be set by turning the rollers (→ "Fig. 44-2"). Smaller numerical values cause a lighter staining intensity; higher numerical values cause a darker staining intensity.
- A handle color must be assigned to the program (→ P. 65 – 5.9.1 Assigning a rack handle color to a staining program).
- Use **Save** to save the settings and close the dialog.
- Use **Cancel** to close the dialog without saving changes.

5 Operation

5.9.4 User-defined staining programs



Warning

- Leica can provide neither testing nor a warranty for user-defined programs.
- The testing of these staining programs using the respectively used reagents and adjusted temperatures must be carried out in the lab by the user. To do so, the staining result has to be checked with a specimen cycle (trial sections) before the program is used for patient specimens for clinical diagnostics.



Note

A new program can be created with the **New** (→ "Fig. 45-1") or **Copy** (→ "Fig. 45-2") buttons. Creating, copying or editing a program requires "Supervisor" mode. The **User** status only allows program steps to be displayed.

5.9.5 Creating or copying a new staining program

- Press the **New** button (→ "Fig. 45-1") in the list view of the programs.



Fig. 45

- A new program window opens (→ "Fig. 46").

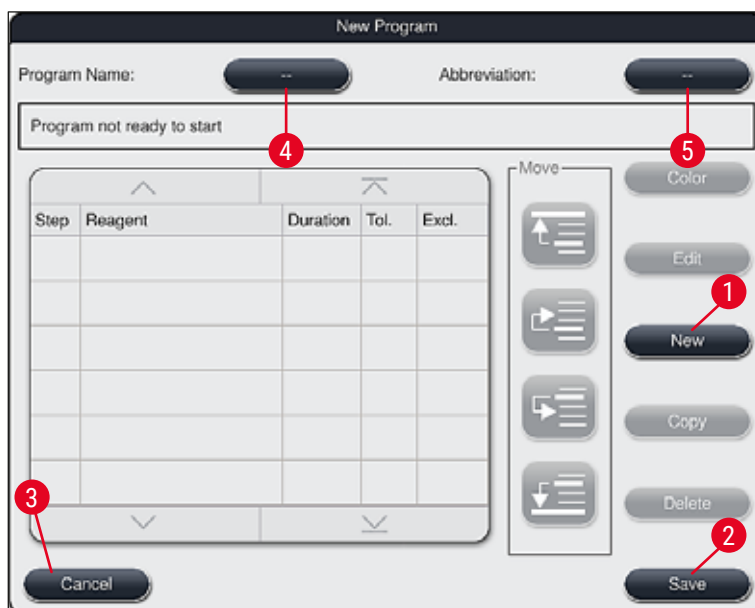

Fig. 46

Two empty buttons are shown in the upper area of this window. They are intended for the program name and its abbreviation.

- Press the -- button behind the **Program Name:** designation (→ "Fig. 46-4"). An input mask with keyboard appears.
- Enter the program name and apply the name entered with the **OK** button.

Proceed as described above to enter the **Abbreviation** (→ "Fig. 46-5").



Note

- To create a new staining program, multiple program steps are added to the program in sequence.
- Please note: User-defined programs cannot be saved with the designation **SPECTRA** as the program name. An information message notifies the user of this when attempting to save. Saving is only possible after entering a different program name.

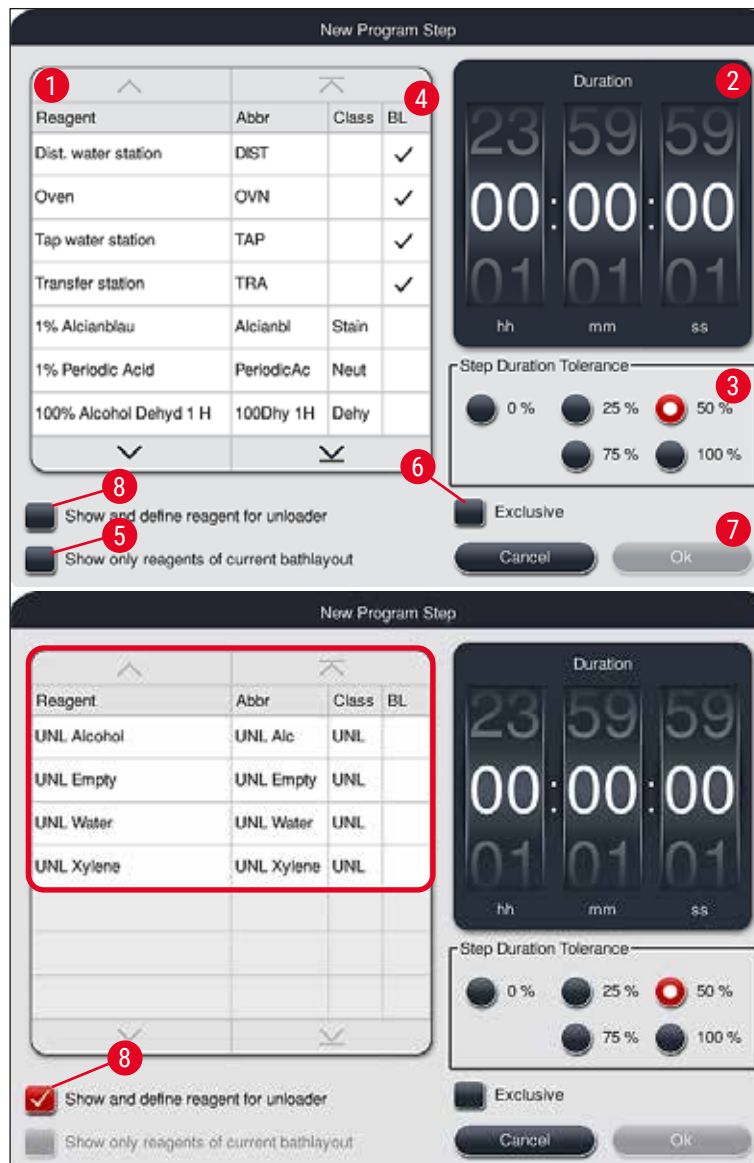

Fig. 47

- After a new program has been created, press the **New** button (→ "Fig. 46-1").
- A window opens for defining the program step (→ "Fig. 47").
- The reagents already predefined by the user are listed in the area on the left (→ "Fig. 47-1"). Tap the reagent to select it.
- Turning the rollers (→ "Fig. 47-2") in the area on the right defines the reaction time (hh/mm/ss) of the specimens in the reagent.
- The valid setting range goes from 1 second up to 23 hours 59 minutes and 59 seconds.
- Here, the permitted **Tolerance** (→ "Fig. 47-3") of the step is configured. If an exact program step is needed that does not allow any temporal extension of the specified time, the tolerance 0 % must be selected. The tolerance can be selected in 25 % increments up to a maximum expansion of 100 %, i.e. the instrument can extend the step to twice the length of the configured time, if needed.

**Note**

The duration of the individual program steps is composed of the programmed step times plus the configured tolerances. If tolerance configurations for a program step are > 0 %, the remaining station times and expected remaining time for the program may be exceeded.

Copying a program**Note**

If you want to use an existing program with other parameters, then the program can be copied.

- Select the program to be copied in the list view (→ "Fig. 45") by tapping it and press the **Copy** (→ "Fig. 45-2") button.
- It opens the entry window (→ "Fig. 46") for the new program to be created.
- Apply the suggested program name or overwrite it with a new program name.
- Then, enter an abbreviation.
- If necessary, change/edit the individual steps of the program as needed or add new program steps (→ "Fig. 46-1") (→ P. 73 – 5.9.6 Inserting or copying a new program step).
- Store the entries with the **Save** button (→ "Fig. 46-2") or close the entry window with the **Cancel** button (→ "Fig. 46-3") without applying the entries.

5.9.6 Inserting or copying a new program step**Inserting a new program step****Note**

A high time tolerance setting is recommended if no negative effects on the staining result are to be expected. This gives the instrument more room to synchronize steps of multiple programs running at the same time.

- If a check mark is present in the **BL** (→ "Fig. 47-4") column, this means that this reagent is already integrated into the bathlayout.
- In order to limit the display to reagents that are already actively being used in the bathlayout, activate the **Show only reagents of current bathlayout** (→ "Fig. 47-5") radio button.
- In order to limit the display to unload drawer reagents, activate the **Show and define reagent for unloader** (→ "Fig. 47-8") radio button.
- If the **Exclusive** (→ "Fig. 47-6") check box is activated, the selected reagent can be used in the created program only and is not available to any other program.
- The program step input is finished with **"OK"** (→ "Fig. 47-7").
- Depending on need, other program steps can be added in the same way until all staining process steps are illustrated in the program.

5 Operation



Note

A program must always be concluded with a final target station step. As the last step, the unload drawer or, in case HistoCore SPECTRA ST is permanently connected as a workstation with a HistoCore SPECTRA CV, the transfer station must be selected.

An information message (→ "Fig. 48") indicates that it is not possible to save the program without defining the target station as the final step.

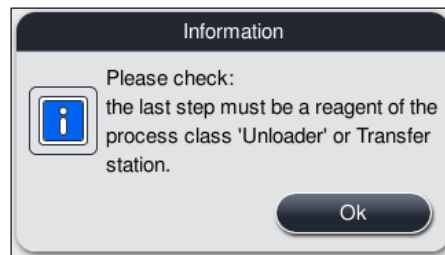

Fig. 48

Copying a program step



Note

When creating or modifying a program, a program step can be copied with the previously set parameters and modified to a reagent which is currently in the reagent list.

- Mark the respective program step by touching it and press the **Copy** button (→ "Fig. 49-5").
- The **Edit program step** window (→ "Fig. 49") opens.
- If a reagent with only one instance present has been selected, an information message notifies the user of this fact. In this case, a different reagent is to be selected for the program step.
- The parameters (Tolerance, Duration and Exclusive) of the originally selected program step are retained.
- If necessary, modify the parameters for the program step correspondingly or apply the present ones and press the **OK** button.
- The program step is placed at the end of the program.
- Reorder the program step as described in (→ P. 75 – 5.9.7 Re-sorting program steps).

5.9.7 Re-sorting program steps

- The program step is highlighted in red upon selection. Now, the **Move**-buttons (→ "Fig. 49-1") (→ "Fig. 49-2") (→ "Fig. 49-3") (→ "Fig. 49-4") are active.

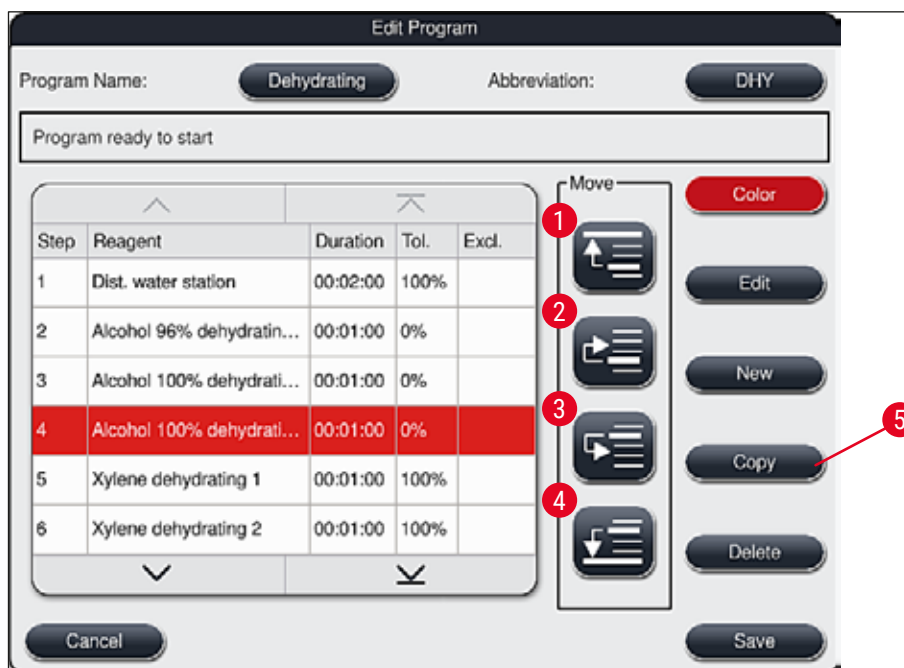

Fig. 49

- Press to move the selected program step to the first row.
- Press to move the selected program step one row up.
- Press to move the selected program step one row down.
- Press to move the selected program step to the last row.



Warning

If an oven step is used as the first program step, a flammable solvent must not be present in the load station of the load drawer under any circumstances.

This may cause a ignition in the oven, which can cause the operator to be burned, specimen loss and damage to the instrument and equipment.

- Using the **Save** (→ "Fig. 49") button, the changes are accepted. Press the **Cancel** button to discard the changes.

5.9.8 Prioritizing programs for executing the bathlayout

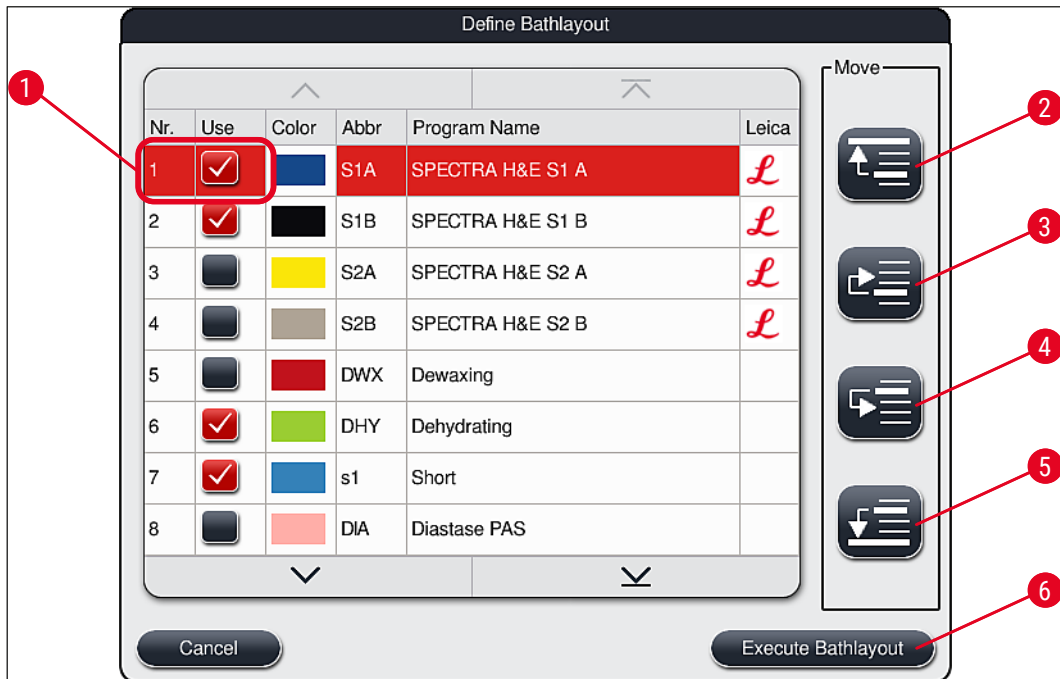

Fig. 50

After all desired staining programs have been entered, the bathlayout has to be generated. To do so, proceed as follows:

- In the first step, the **supervisor** should define which programs are to be accepted into the bathlayout. The programs are activated using the radio button(s) (→ "Fig. 50-1").
- The position of the program determines its priority for integration into the bathlayout.



Note

Priority:

- Only the positions of the user-defined programs can be moved. Leica staining programs are always listed at the upper positions of the reagent list.
- The user-defined programs with low position numbers are easier to take into account when executing the bathlayout than programs with high position numbers.
- We recommend positioning user-defined programs with high specimen throughput at the beginning of the program list, following the Leica staining programs.

If a staining program is to be assigned a different higher or lower prioritization, touch it in the list and it move up or down in the list using the **Move** buttons:



- Program is moved to the top of the list (→ "Fig. 50-2")



- Program is moved up by one row (→ "Fig. 50-3")



- Program is moved down by one row (→ "Fig. 50-4")



- Program is moved to the bottom of the list (→ "Fig. 50-5")

- Due to the new priorities, the bathlayout must be newly executed (→ P. 77 – 5.9.9 Executing the bathlayout).

5.9.9 Executing the bathlayout



Note

The arrangement of the reagent stations in the instrument is calculated using the prioritized staining programs (→ P. 76 – 5.9.8 Prioritizing programs for executing the bathlayout).

These are some things to be observed when doing so:

- Leica staining programs are taken into account first,
 - Staining and differentiation solutions are placed as close as possible to the rinsing water vessels,
 - The program prioritization and process class assignment are observed,
 - Sequential process reagents must be located close to each other.
- For selection of the programs to be integrated into the bathlayout, press the **Define Bathlayout** (→ "Fig. 45-3") button.
 - Mark and prioritize the respective programs, then press the **Execute Bathlayout** (→ "Fig. 50-6") button or **Cancel** to return to the program selection.



Warning

Be sure to observe the information message (→ "Fig. 51") displayed after pressing the **Define Bathlayout** button. Press the **Continue** button to have the result of the calculation of the bathlayout displayed.

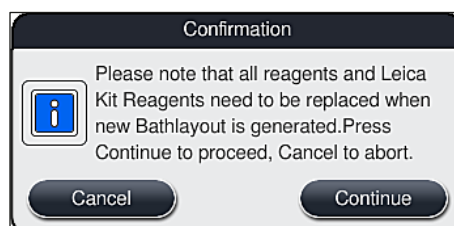

Fig. 51

5 Operation



Note

- If more programs have been selected than could be integrated into the bathlayout, the user is informed by the **Bathlayout Generation Result** (→ "Fig. 52") display. Successfully integrated programs are marked with a check mark in the **Ready** (→ "Fig. 52-1") column.
- For programs that cannot be integrated, the reason (→ "Fig. 52-2") is specified in the **Not ready, Causes** (→ "Fig. 52-3") column.
- Note that the list must be inspected all the way through.

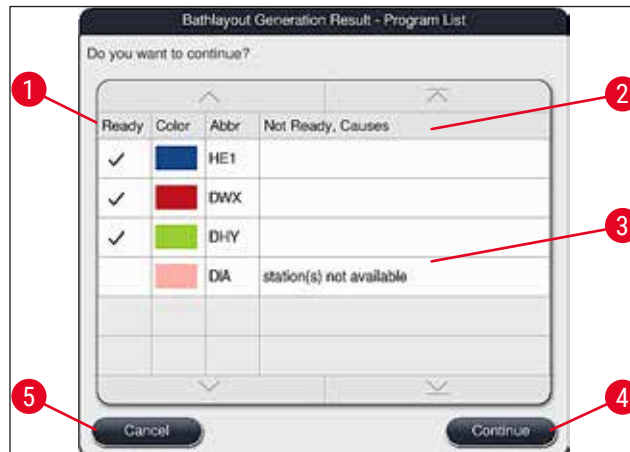

Fig. 52

- Press the **Continue** button (→ "Fig. 52-4") to proceed or **Cancel** button (→ "Fig. 52-5") to return to the program selection (→ "Fig. 50").



Warning

Additionally, the instructions for use provided with the Leica reagent kits must be observed before scanning Leica reagents!

5.9.10 Filling reagents after bathlayout execution



Note

- Execute the bathlayout and proceed as described (→ P. 77 – 5.9.9 Executing the bathlayout).
- If the bathlayout shown is only to be saved without configuring the reagent filling, press the **Save** button (→ "Fig. 53-3"). The saved bathlayout can then be called up in the bathlayout menu. If necessary, subsequent adjustments can be made in this menu (→ P. 85 – 5.9.11 Adapting a bathlayout). Filling the reagent vessel can also be configured to take place at a desired point in time using the bathlayout menu (→ P. 94 – 6.4 Station details).



Warning

- Especially for the vessels of the unload stations, it is mandatory that all vessels are filled up over the minimum filling level (→ P. 90 – 6.2.1 Preparation and handling of reagent vessels). The exception are unload stations, with the assignment the UNL Empty.
- However, in the case of duplicated unload stations, if only one station is sufficiently filled, the program may be ready to start. This can have a negative effect on the unloading capacity and can lead to interruptions in the staining process.
- The availability of the unload stations must be checked after the fill level scan and corrected if necessary.

- After the software calculates the bathlayout using the prioritized programs, the user obtains an overview of the results displayed on the screen (→ "Fig. 53").



Note

- If no Leica programs have been integrated into the bathlayout, the display (→ "Fig. 53") deviates from the one shown (not pictured). In this case, the reagents can be filled as described in (→ P. 81 – Filling the reagents).
- If Leica programs are to be integrated in the bathlayout, at least 2 unload stations with the assignment **UNL Xylene** at position **U04** and **U05** are taken into account when generating the bathlayout.
- If Leica programs have been integrated into the bathlayout, the reagent **95 % Alcohol Dehyd 1** must first be duplicated. The station in question in the bathlayout is identified with a blue outline (→ "Fig. 53-1").
- The reagent **95 % Alcohol Dehyd 1** to be duplicated is displayed with the abbreviation "**95Dhy1**" in the bathlayout.

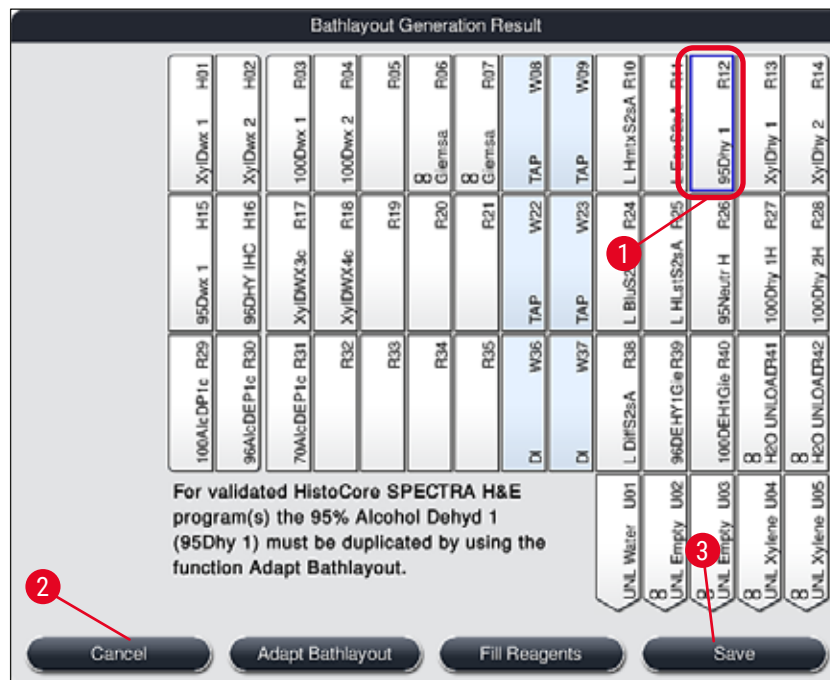

Fig. 53

5 Operation

Duplicating the reagent **95Dhy1**



Note

If there is no reagent station available due to the selected programs, attempt to optimize user-defined programs using the Leica sales organization.

The procedure for duplicating the reagent **95Dhy1** is as follows:

1. Press the **Adapt Bathlayout** (→ "Fig. 53-2") button.
2. Note the subsequent information message and confirm it with **OK**. A new **Clipboard** (→ "Fig. 54") window opens.

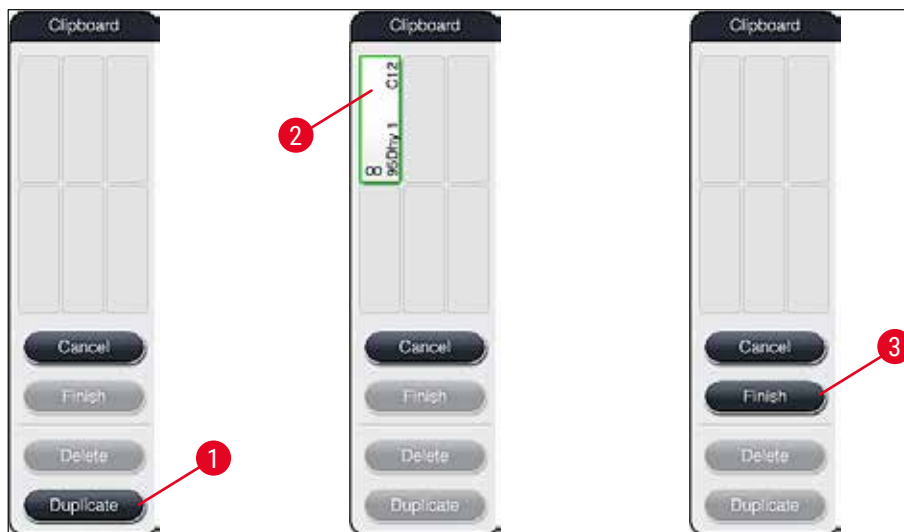

Fig. 54

3. Select the station **95Dhy1** (→ "Fig. 53-1") in the bathlayout by tapping it (station is marked in green) and click on the **Duplicate** button (→ "Fig. 54-1") in the **Clipboard** window. An identical copy of the selected station is now displayed in the **Clipboard** (→ "Fig. 54-2").
4. Select the station in the "**Clipboard**" and then click on an available position in the "**Bathlayout**". The duplicated station is moved from the clipboard to the bathlayout (→ "Fig. 55-1").

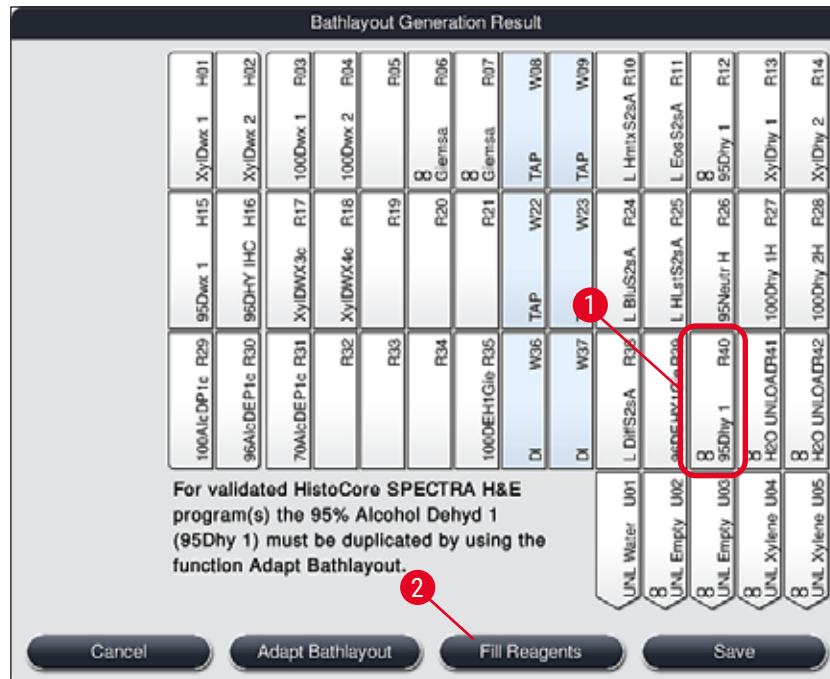

Fig. 55

5. Press the **Finish** button (→ "Fig. 54-3") in the **Clipboard** and confirm the subsequent information message with "Yes" in order to apply the change and close the clipboard.

✓ The successfully duplicated station **95Dhy1** and the original station are displayed with an equivalence symbol (∞) in the bathlayout (→ "Fig. 55-1").

Filling the reagents

1. Press the **Fill reagents** button (→ "Fig. 55-2").
2. In the new **Fill reagents** (→ "Fig. 56") window, the stations to be filled are marked in orange (→ "Fig. 56-1").



Note

Only user-defined and added reagents of Leica staining programs are displayed with an orange marking (→ "Fig. 56"). The reagents from the Leica reagent kit are subsequently scanned (→ P. 82 – Filling the Leica reagent kit reagents).

3. Fill the marked reagent vessels outside of the instrument with the corresponding reagents in sequence and set them back in the correct position in the instrument.
4. Confirm filling and resetting the reagent vessels by pressing the respective station (→ "Fig. 56-1") on the screen.
5. Repeat these steps for all stations marked in orange, including the unload stations (→ "Fig. 56-2").

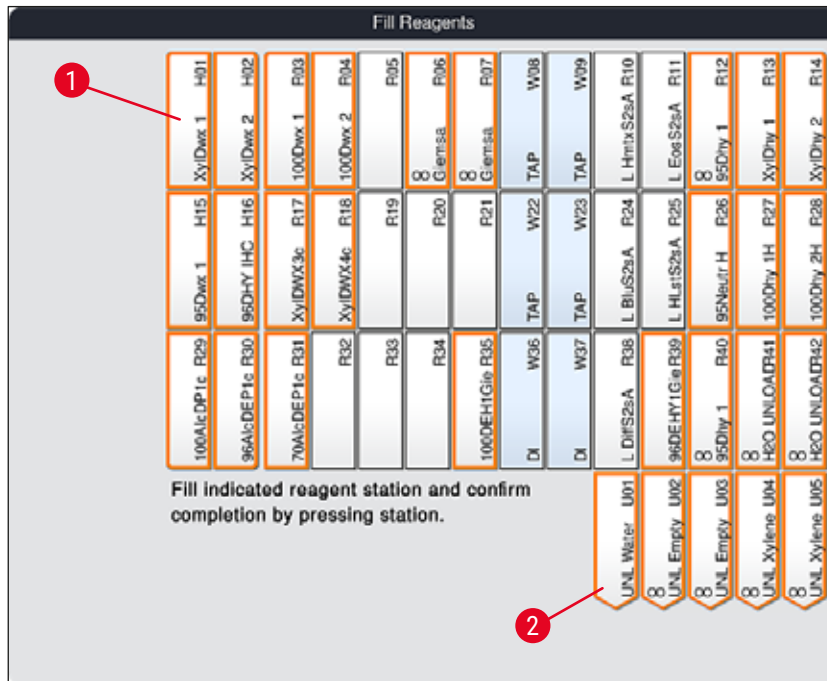

Fig. 56



Warning

The arrangement of the assignment plan is to be followed exactly. Any deviation can lead to undesired staining results.

Filling the Leica reagent kit reagents



Note

After duplicating the reagent station **95 % Alcohol Dehyd1** (→ P. 80 – Duplicating the reagent 95Dhy1) and filling the reagents (→ P. 81 – Filling the reagents), the Leica kit reagents are finally scanned.

1. When prompted by an information message (→ "Fig. 57") on the screen, hold the carton's packaging label in front of the RFID sensor on the front of the instrument (→ "Fig. 58-1") to scan it.
2. Then, begin to scan in the first Leica reagent bottle after being prompted by an information message (→ "Fig. 58-2"). Hold the reagent bottle label in front of the RFID sensor on the front of the instrument (→ "Fig. 58-1") in order for it to be scanned.
3. In the new window **Change Leica kit reagent** (→ "Fig. 59"), the station to be filled is marked in orange (→ "Fig. 59-1").
4. Fill the marked reagent vessel outside of the instrument with the corresponding Leica reagent and set it back in the correct position in the instrument.
5. Confirm filling and resetting the reagent vessel by pressing the respective station (→ "Fig. 59-1") on the screen.
6. Then, scan the labels of the individual reagent bottles when prompted (→ "Fig. 58-2") and repeat steps 2-5.

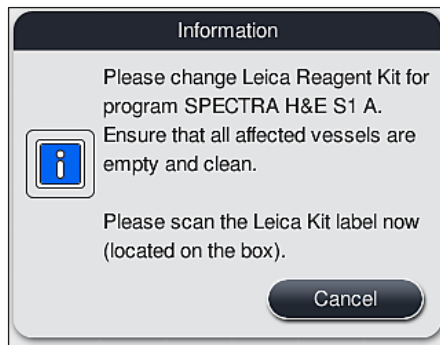

Fig. 57



Fig. 58

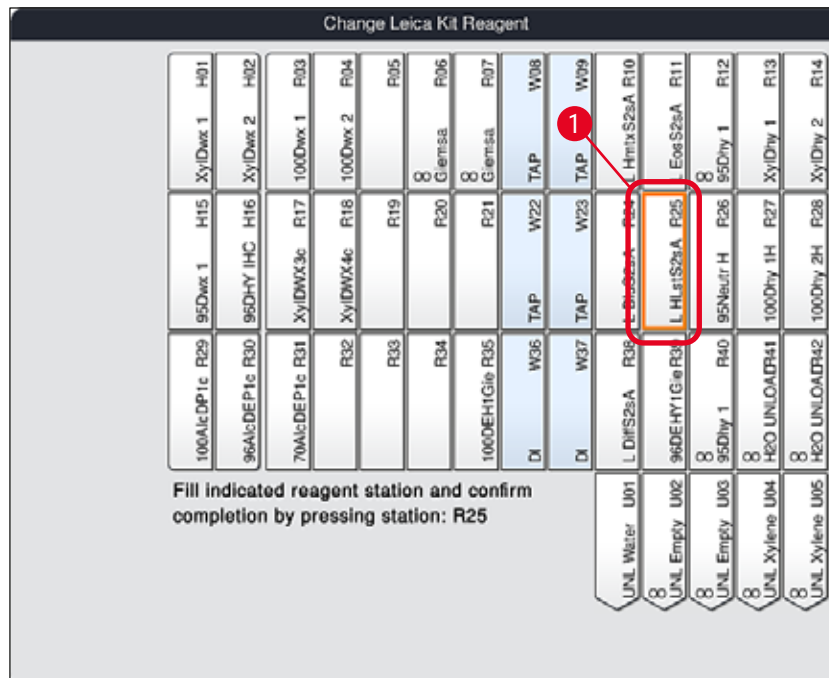

Fig. 59

5 Operation



Note

The user has 5 minutes to scan the reagents for the carton's packaging label and 5 minutes per reagent bottle.

If scanning a reagent bottle or packaging label fails, the user has 2 additional attempts before the reagent labels become invalid.



Warning

Each Leica reagent kit can only be scanned only once!

- Scanning the Leica reagent kit can only be canceled by using the **Cancel** button in the information message shown in (→ "Fig. 57") and before starting scanning the package label without the Leica reagent kit expiring.
- The scanning can take place later. More information necessary for this procedure is described in (→ P. 100 – Reagent replacement) (→ "Fig. 76") and (→ "Fig. 78").
- If the operation is not canceled until after scanning the first label (packaging cardboard), the Leica reagent kit expires.



Note

The reagent management system (**RMS**) automatically applies the following data for the Leica reagents:

- The use-by date (once opened)
- The remaining number of specimen slides
- The max. number of specimen slides
- The expiry date
- The lot number



Warning

- The arrangement of the bathlayout is to be followed exactly. Any deviation can lead to undesired staining results.
- All of the Leica reagent kit bottles are to be scanned.
- Make sure that no Leica reagents from different Leica reagent kits are used.
- Reagent vessels must always be filled outside of the instrument in compliance with the safety information.



Note

The user is finally prompted by an information message on the screen to start the automatic fill level scan. Press the **OK** button in the information message (→ "Fig. 60") to start the scan.

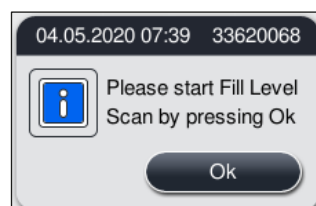

Fig. 60

5.9.11 Adapting a bathlayout

**Warning**

The automatically and optimally executed bathlayout should be adjusted only if special user requirements have not been taken into account or if this is required by a Leica program. For this reason, the instructions for use provided with the Leica reagent kits must be observed! Supervisor mode is needed to adjust the bathlayout.

Each adjustment of the bathlayout can have a negative effect on the specimen throughput and staining result!

The following rules must be observed when adjusting the bathlayout:

- Reagent stations must not be moved from one side of the vessel field to the other because this causes unnecessarily long transfer times.
- Duplicate stations have to be on the same side of the vessel field (→ "Fig. 40") (→ "Fig. 65"), otherwise the adjustment to the bathlayout cannot be saved.
- In order not to hinder the unloading capacity and to prevent unexpected interruptions of the staining process, an unload reagent must be assigned to each of the 5 unload stations (→ P. 70 – 5.9.5 [Creating or copying a new staining program](#)).
- If an unload station is to be used for unloading into an unfilled vessel, the correct assignment must be made at the end of the program to **UNL Empty** in any case (→ P. 62 – 5.8.3 [Process classes](#)). Under no circumstances should an unused position within the 5 unload stations be created by deleting a reagent already assigned to the unload station. This can have a negative effect on the unloading capacity and can lead to interruptions in the staining process.

**Note**

By generating the bathlayout, the selected reagents of the last program step (**UNL**, for unloading) are automatically assigned to the individual unload stations. For this purpose, it is essential to check whether the assigned number of specific unloading stations corresponds to the user expected throughput and workflow in the lab. The ratio of the assigned unload stations to each other can be changed by the function **Adapt Bathlayout**. Individual unload stations can be duplicated or deleted if necessary.

If you need to adjust the bathlayout executed by the HistoCore SPECTRA ST, which takes into account all rules for optimization, this can be done by means of the function **Adapt Bathlayout** (→ "Fig. 61-1").

Using this function, station placements can be moved to their positions within the bathlayout and/or duplicated.

To do so, proceed as follows:

1. In the bathlayout view (→ "Fig. 61"), press the **Adapt Bathlayout** button (→ "Fig. 61-1").
2. Observe the information messages that follow (→ "Fig. 62")(→ "Fig. 63") and confirm them or press **Cancel** (→ "Fig. 63") to return to the bathlayout view.
3. After confirmation, the **Clipboard** (→ "Fig. 64") will open, to which up to 6 reagent stations (→ "Fig. 64-1") can be moved.



Fig. 61

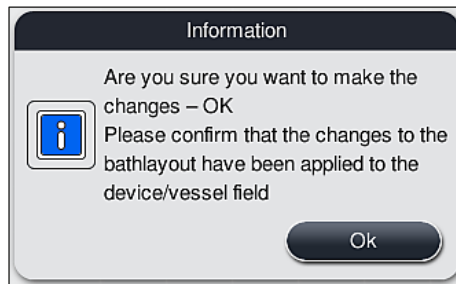

Fig. 62

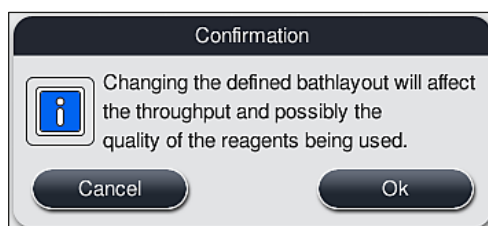

Fig. 63

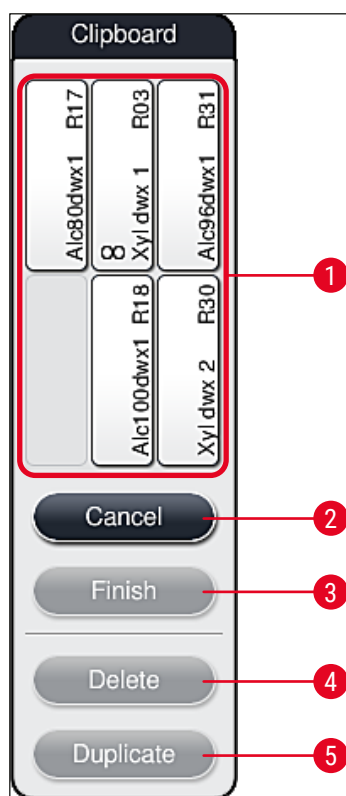

Fig. 64

**Note**

- Leica reagent stations, which are marked by an L before the reagent name (→ "Fig. 61-3"), can be moved but not duplicated.

**Note**

- The clipboard can be closed only if no more reagent stations are in it.
- An information message on the screen prompts the user to start the automatic fill level scan after each change made using the **Adapt Bathlayout** function. Press the **OK** button in the information message to start the scan.

There are two options for changing the bathlayout:Moving reagent stations:

1. To move reagent stations, select them individually in the bathlayout (→ "Fig. 61") by touching the screen and then tapping an available position in the clipboard (→ "Fig. 64-1").
2. This moves the reagent station to the clipboard (→ "Fig. 64-1").

5 Operation

3. Finally, select the reagent station in the clipboard by tapping and dragging it to the desired (available) station (→ "Fig. 61-2") in the bathlayout.
4. To save your changes, press the **Finish** (→ "Fig. 64-3") button and confirm the subsequent information message with a **Yes** or **No** to return to the clipboard.
5. To delete the changes, press **Cancel** (→ "Fig. 64-2") and answer the subsequent information message with a **Yes**.

Duplicate a reagent station

1. To duplicate a reagent station, select it in the bathlayout by touching the screen.
 2. Following this, press the **Duplicate** (→ "Fig. 64-5") button.
 3. As a result, the reagent station appears in the clipboard. This station and the original station are displayed with an equivalence symbol (→ "Fig. 61-4").
 4. After this, select the duplicate reagent station in the clipboard by touching the screen and place it in the desired (available) station, near the original station in the bathlayout.
 5. To save your changes, press the **Finish** button and confirm the subsequent information message with a **Yes** or press **No** to return to the clipboard.
- To delete the changes, press **Cancel** and answer the subsequent information message with a **Yes**.



Note

- Duplicated reagent stations make sense for program steps with a long dwell time in a reagent. Duplicated stations make two equivalent reagent stations available for a program step, which ensures getting a high specimen throughput.
- Duplicated reagent stations can be deleted using the **Delete** button (→ "Fig. 64-4"). To do so, mark them in the bathlayout by touching them and pressing the **"Delete"** button.

6. Daily Instrument Setup

6.1 Preparing the instrument for daily setup



Note

- (→ "Fig. 65") shows an overview of the various stations in the vessel field.
- Altogether, the vessel field consists of 36 reagent stations and 6 rinsing water stations.
- The max. capacity of each reagent vessel is 380 ml.

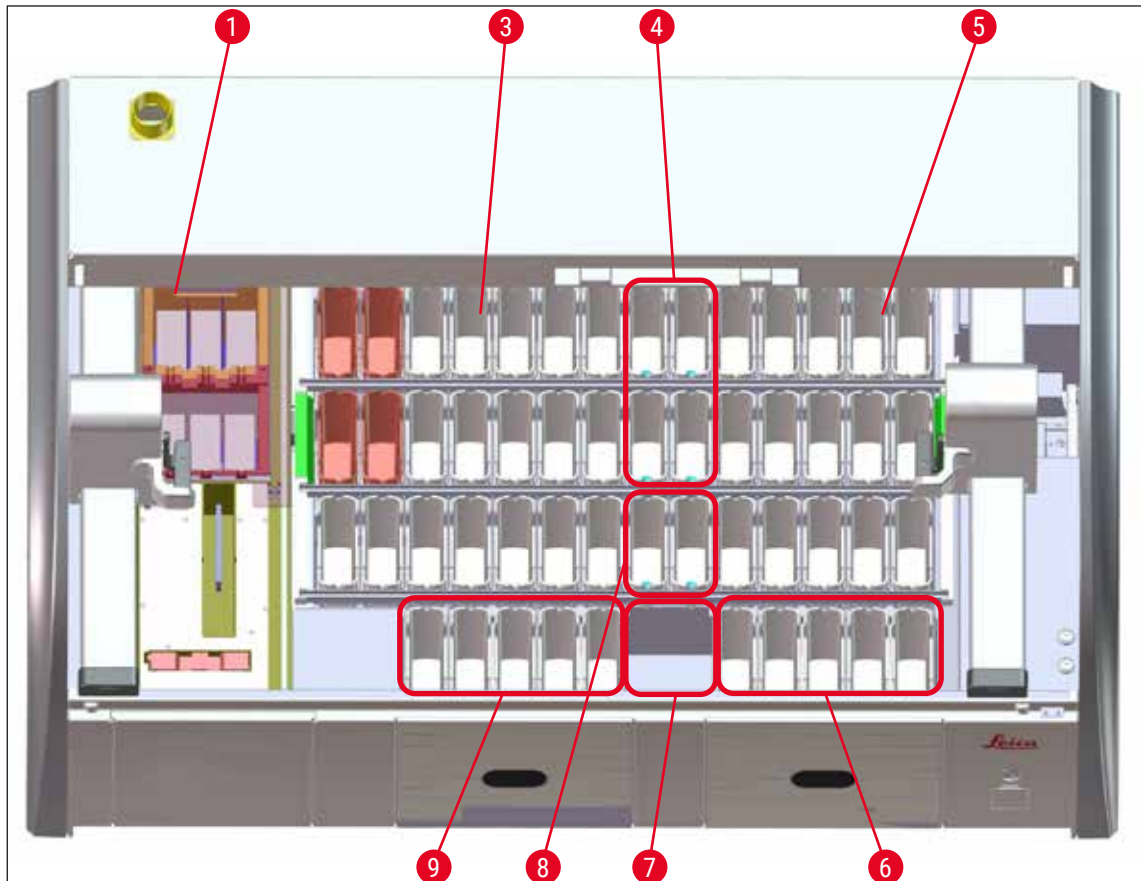

Fig. 65

- 1 6 oven stations
- 3 Left vessel field
- 4 Rinsing water stations (group of four)
- 5 Right vessel field
- 6 5 unload stations
- 7 Dry transfer station
- 8 Rinsing water stations (group of two)
- 9 5 load stations

6.2 Daily instrument setup



Note

Before setting up the instrument every day, check the water inlet to the instrument and turn it on if necessary.

- Open the instrument hood and remove the covers from the reagent vessels.
- Switch on the instrument.

Automatic fill level scan when initializing the instrument

During the initialization, fill level scans are automatically carried out in the following areas:

- Reagent vessels
- Rinsing water vessels
- Reagent vessels of the load and unload stations
- Oven station



Note

If the instrument still contains racks, reagent vessels that are insufficiently filled or still covered, and/or rinsing water vessels that are not ready for use, this is detected during the automatic fill level scan and displayed when finished.

6.2.1 Preparation and handling of reagent vessels

To ensure that everything runs smoothly in the instrument, observe the following notes and proceed as follows.

Attaching the reagent vessel handle

Check whether the reagent vessel handle is correctly attached to the reagent vessel. If this is not the case, fasten the handle according to (→ "Fig. 66").

Filling and draining reagent vessels



Warning

The reagent vessels are always to be filled or drained outside of the instrument to avoid or reduce the risk of spilling reagents into other reagent vessels and onto interior instrument components. Proceed carefully when filling or draining the reagent vessels and follow the respectively applicable laboratory specifications. If reagents have been spilled or another reagent station has been contaminated, it must be cleaned and re-filled. The vessels must be covered when not using the instrument to prevent the unnecessary evaporation of the reagents.

Correct fill level of the reagent vessels

- When filling either reagent vessel type, observe the fill level marks inside the reagent vessels (→ "Fig. 66") (→ "Fig. 67").
- A sufficient filling level is ensured if the level of the reagents is between the maximum (→ "Fig. 66-1") and minimum (→ "Fig. 66-2") fill level marks.
- If inserts for special stainings (→ "Fig. 67") are used in the reagent vessels in order to reduce reagent volume, insert these into the reagent vessel first and then fill the reagent at least up to the minimum filling level indicated (→ "Fig. 67-2"), but not over the maximum filling level (→ "Fig. 67-1").

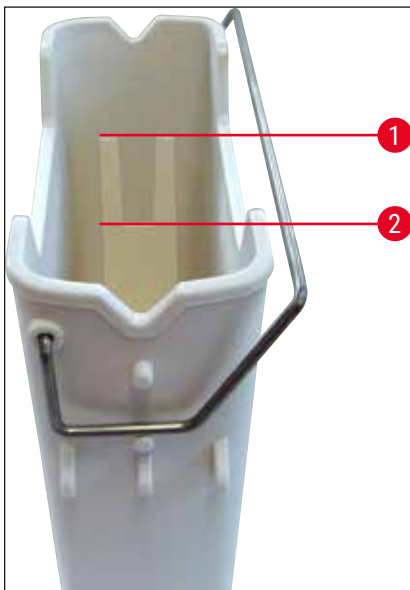

Fig. 66

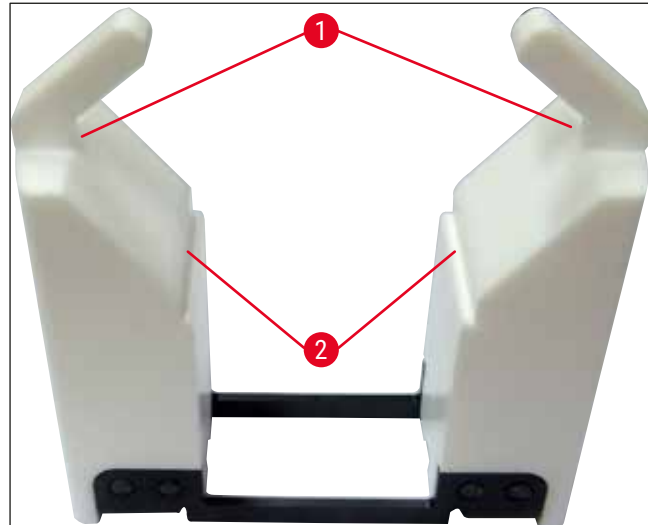

Fig. 67

Inserting the reagent vessel into the vessel field

- Select **Bathlayout** (→ P. 40 – 5.5 Main menu - overview) in the main menu and insert the reagent vessel into the correct position according to the arrangement of the bathlayout.



Note

Carefully insert the reagent vessel with handle into the vessel field so that the handle is on the right side of the reagent vessel when looking at the vessel field (→ "Fig. 68-1"). This orientation of the handle is recommended also for placing the reagent vessels in the loader or unloader station.



Note

Like the rack handle for 5 slides, the insert for special stainings is equipped with a special coating that prevents chemical interactions with reagents for special applications (e.g. Prussian blue staining for iron detection, silver stains such as Grocott or Gomori). For more information about reagents that should be used with coated accessories, see (→ P. 163 – A1. Appendix 1 - Compatible reagents).

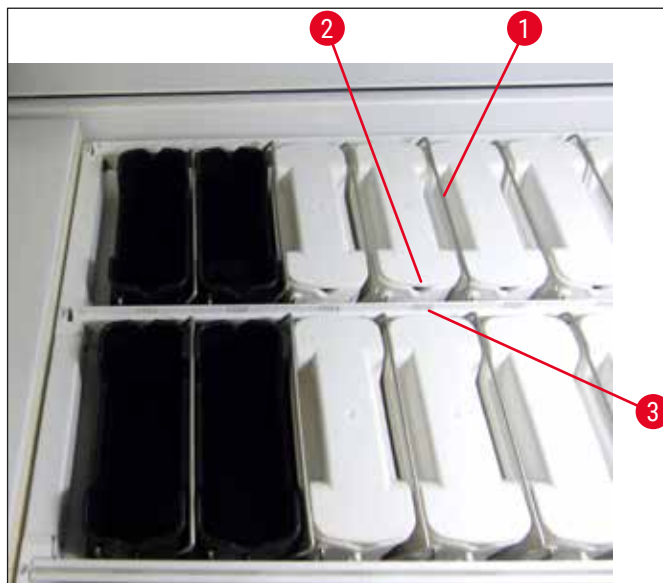

Fig. 68

**Warning**

Do not insert the reagent vessels into the instrument laterally offset from the station number. To do so, make sure that the notch on the front side of the reagent vessel (→ "Fig. 68-2") and the station number (→ "Fig. 68-3") are at the same height.

6.2.2 Automatic fill level scan

After filling and inserting the reagent vessels, the automatic fill level scan (→ "Fig. 69-1") should be carried out for verifying that all reagents used have the correct fill level.

**Note**

- The load and unload stations are not taken into account when executing the bathlayout. Reagents in the load and unload stations have to be defined and monitored by the user.
- The reagents in the load and unload stations are not monitored by the reagent management system. Therefore the user is responsible for making sure the reagents in these stations are in flawless condition.

To start the fill level scan manually, proceed as follows:

1. Call up the **Bathlayout** (→ P. 40 – 5.5 Main menu - overview) in the main menu.
2. The **Fill Level Scan** (→ "Fig. 69-1") button is in the lower part of the menu screen.
3. Press this button to start the fill level scan.

**Note**

Irregularities during the fill level scan are displayed on the screen. Follow the information messages and, for example, correct the fill level, remove the cover, add reagent vessels, etc.

6.3 Reagent management system (RMS)



The bathlayout (→ "Fig. 69") in the instrument is displayed by pressing the adjacent menu button. This display shows the current layout of the reagent stations, the rinsing water stations and the load and unload stations in the instrument.



Fig. 69

The bathlayout is empty when the instrument is delivered because reagents still have not been defined and a bathlayout has not yet been executed.

If reagents (→ P. 59 – Creating a new reagent or copying a reagent) and programs (→ P. 70 – 5.9.5 Creating or copying a new staining program) have been defined and the bathlayout has been executed (→ P. 77 – 5.9.9 Executing the bathlayout), the overview (→ "Fig. 69") shows all stations in the instrument in their real order.

Each reagent vessel shown in the bathlayout contains additional information:

- Station number (→ "Fig. 69-2")
- Abbreviating the reagent name (→ "Fig. 69-3")
- A background color (→ "Fig. 70")
- Equivalence symbol for a duplicated reagent station (→ "Fig. 69-4")



Note

- The background color shows the consumption status of the reagent (→ "Fig. 70"). As the reagent is consumed, the color bar rises from the bottom to the top and changes color based on the consumption status.
- As soon as the **RED** (→ "Fig. 70-3") consumption status has been reached, and absolutely no later than when the station flashes red, the reagent in question must be replaced. If this is not done, Leica staining programs are no longer able to start.
- For further information on the RMS, see (→ P. 58 – 5.8 Reagent list).

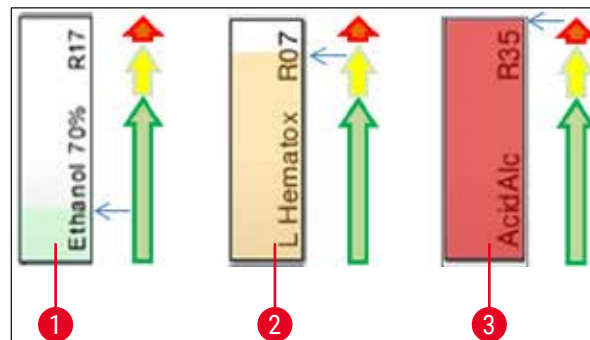

Fig. 70

- 1 Green: Consumption status between 0–80 % of the maximum use limit
- 2 Yellow: Consumption status between 80–95 % of the maximum use limit
- 3 Red: Consumption status between 95–100 % of the maximum use limit

6.4 Station details

Touching a station in the bathlayout will display more information (station details). The following station types are distinguished by their abbreviation:

L01-L05	Load stations
SID	Specimen slide counter station and title block identification (optional)
001-006	Oven stations for drying the specimen slides and starting to melt the paraffin
R01-R42	Reagent stations
W08-W09	Rinsing water stations (group of four)
W22-W23	
W36-W37	Rinsing water stations (group of two)
D01-D02	Dry transfer stations
U01-U05	Unload stations in the unload drawer

Specimen slide counter station (SID):

Touching this station causes a note to appear indicating that this station is the specimen slide counter station. The **Close** (→ "Fig. 71") button is used to close the display.

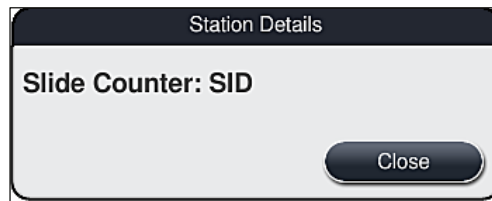

Fig. 71

Oven stations:

The detail view (→ "Fig. 72") of an oven station shows:

- The current temperature (→ "Fig. 72-1"),
- The target temperature adjustment (→ "Fig. 72-2") and
- The operating mode (→ "Fig. 72-3") of the 6 oven stations.

The **Close** (→ "Fig. 72-4") button is used to close the display.

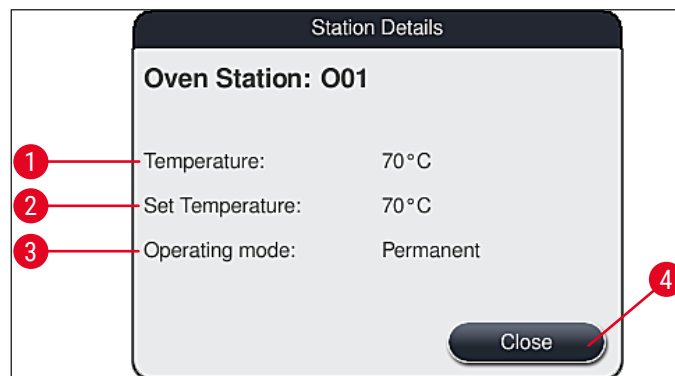

Fig. 72

Rinsing water stations (group of four):

The detail view of a rinsing water station (→ "Fig. 73") shows all other rinsing water stations that are connected to the same water circuit. The **Close** button is used to close the display.



Fig. 73

Rinsing water stations (group of two):

When you tap a rinsing water station of a group of two, an information window opens that shows the 2 water stations, which are connected to the second water circuit with, for example, distilled water or demineralized water (→ "Fig. 74-1") or rinsing water (→ "Fig. 74-2").

**Note**

Based on the connected supply (→ P. 29 – 4.2.1 Joint connection of all 6 rinsing water stations) (→ P. 30 – 4.2.2 Combined connection 4+2 rinsing water stations), the corresponding selection must be made in this menu.

The rinsing water stations (group of two) can only be programmed in **Supervisor** mode.

**Warning**

The correct assignment and connection of the rinsing water vessels is absolutely necessary for achieving good staining quality.

- To apply the settings, press the **Save** (→ "Fig. 74-3") button or press **Cancel** (→ "Fig. 74-4") to close the display without applying potential changes.

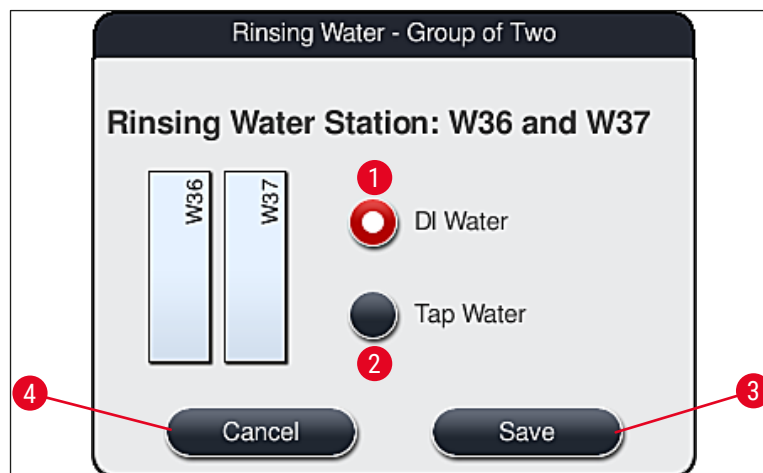

Fig. 74

Load stations in the load drawer

No reagents have been assigned yet to the loaders in the factory condition of the instrument.

If a reagent is to be assigned to a loader, run the following steps:

1. Select the corresponding station in the bathlayout (→ "Fig. 19-1") by touching it.
2. In the newly opened **Station Details** window, press the black **Reagent name** (→ "Fig. 75-1") button to open the list of available reagents (→ P. 58 – 5.8 Reagent list).
3. Select the desired reagent by touching it and then hit **Apply**.

- To apply the settings, press the **Save** (→ "Fig. 75-2") button or press **Cancel** (→ "Fig. 15-3") to close the display without applying potential changes.

✓ The assigned reagent name is displayed in the bathlayout.

If a reagent is no longer required in the selected load station, the assignment to the respective reagent can be removed using the **Clear** (→ "Fig. 75-4") and **Save** (→ "Fig. 75-2") buttons in the **Station Details** window.

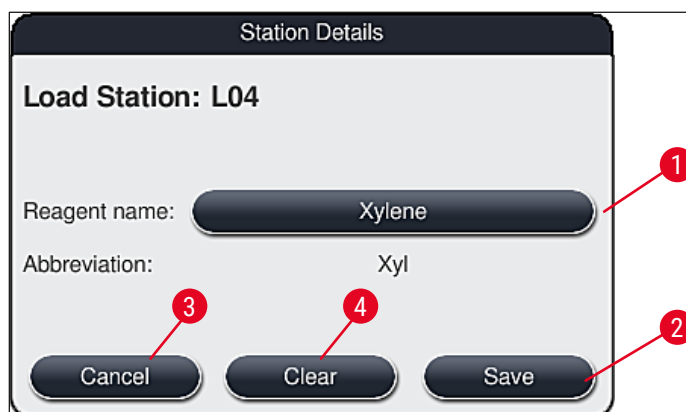

Fig. 75



Note

The load stations are not taken into account when executing the bathlayout. Reagents in the load stations have to be defined and monitored by the user.

Unload stations in the unload drawer

The assignment of the reagents to the 5 unload stations depends on the assignment of the last steps of the selected programs implemented in the bathlayout. The last step of a program must be either an Unload Station within the unload drawer or the Transfer Station to the HistoCore SPECTRA CV in workstation mode. If the program is to end in one of the 5 unload stations, it is mandatory to assign a created or predefined reagent of the process class **UNL** as the last program step.



Warning

The racks are either transported to the Transfer Station at the end of the program or into a free unload station, filled with the correct unload reagent defined in the program as last step. The samples can potentially become damaged if this is not observed.

Due to the possible different assignments of the unload stations, finished racks must be removed from the unload stations in due time. If this is not observed, this can have negative effects on the unloading capacity and can lead to interruptions in the staining process.

Reagent stations and unload stations

An information window opens when the reagent station or unload station is touched. It displays additional relevant data regarding the station type (reagent station (→ "Fig. 76"), Leica reagent station (→ "Fig. 78"), unload station).

Reagent name (→ "Fig. 76-1"), Abbreviation (→ "Fig. 76-2")	(→ P. 59 – Creating a new reagent or copying a reagent)
Unload Station reagent name (→ "Fig. 77-1")	
Consumption status (→ "Fig. 76-3")	(→ P. 93 – 6.3 Reagent management system (RMS))
Remaining slides (→ "Fig. 76-4"), Slides max. (→ "Fig. 76-6")	Displays the number of remaining processable specimen slides. When inserting a rack into the instrument, the slides contained in it are counted by the specimen slide counter station and subtracted from the number of remaining slides.
Slides since exchange (→ "Fig. 76-5")	Displays the number of specimen slides processed since the last reagent changeover.
Onboard shelf life after opening (→ "Fig. 76-7")	Displays the shelf life of the reagent filled into the reagent vessel.
Insert Yes/No (→ "Fig. 76-8")	Yes indicates that the insert for special stainings and the rack for 5 slides is used. This station cannot be used for programs with racks for 30 slides (→ P. 58 – 5.8 Reagent list).
Exclusive Yes/No (→ "Fig. 76-9")	The Yes setting defines that the reagent is only assigned to one program. No allows use by multiple programs (→ P. 73 – 5.9.6 Inserting or copying a new program step).
Expiry date (→ "Fig. 78-1"), Lot number (→ "Fig. 78-2")	is applied automatically when scanning the packaging of the Leica reagent kit.

Detail view of reagent station

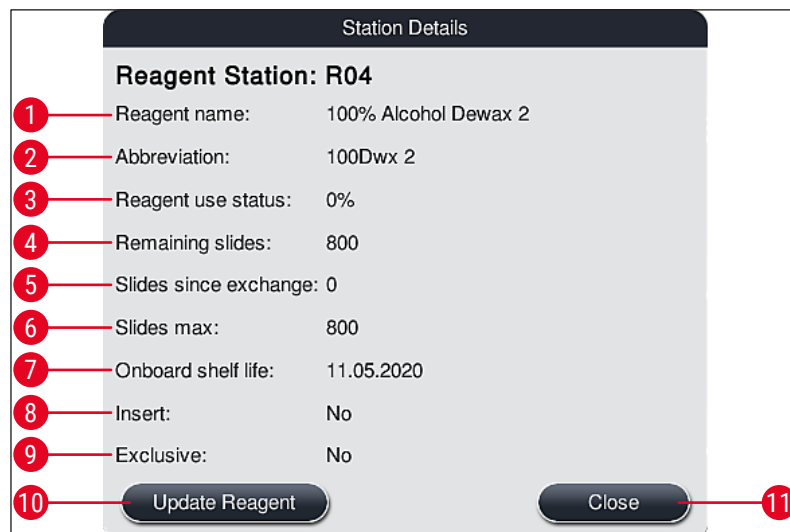

Fig. 76

Detail view of unload station

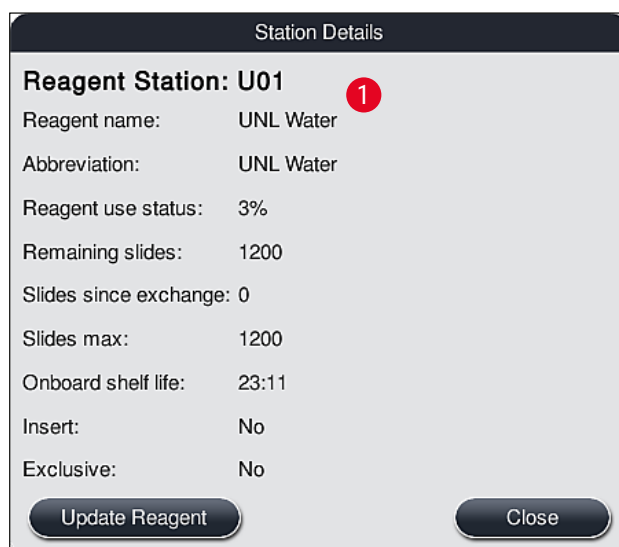

Fig. 77

Detail view of Leica reagent station

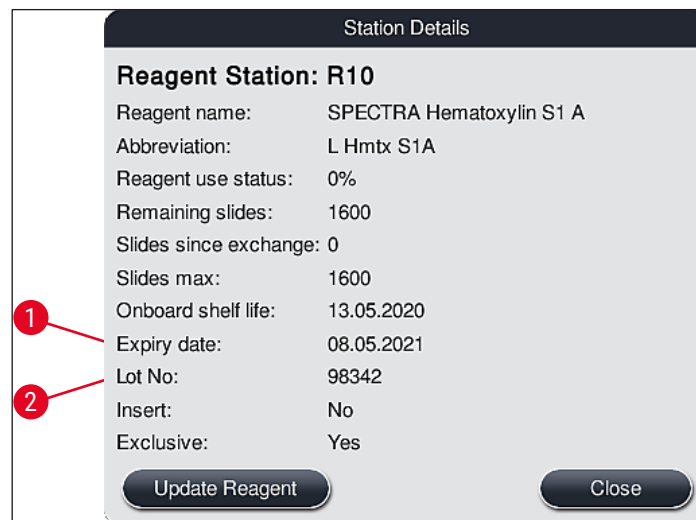

Fig. 78

Reagent replacement

- If the RMS indicates that a reagent is almost or completely consumed, a reagent change must occur. This changeover must be confirmed by pressing the **Update Reagent** (→ "Fig. 76-10") button.
- When replacing the Leica reagents, first press the **Update Reagent** button and follow the instructions for scanning and filling shown on the screen (→ P. 82 – Filling the Leica reagent kit reagents).
- The **Close** (→ "Fig. 76-11") button is used to close the display.



Note

- Please note: Replacement of reagents followed by an update to the RMS data is only possible if the instrument is in an operational state and there are no longer any racks in the instrument (including the load and unload drawers).
- If a user-defined staining program is still being used despite a required reagent changeover, the number of specimen slides will exceed the **Maximum specimen slide** (→ "Fig. 76-6") value. The exceeded number of specimen slides can be determined by comparing the information in the **Slides since exchange** and **Max. specimen slides** rows in the station details (→ "Fig. 76-5").
- A limit of 30 excess specimen slides applies to reagents in Leica reagent kits. This limit does not apply to additional reagents associated with the Leica program (e.g. alcohol, xylene).



Warning

- Updating the reagent status without replacing the corresponding reagent will inevitably affect the staining quality negatively.
- **NEVER** press the **Update Reagent** button if the reagent has not been replaced.



Note

Each Leica reagent kit can only be scanned once!
 Already added Leica reagents expire before their use-by date if a bathlayout is newly executed.

6.5 Preparing the rack



Warning

- Each rack handle (→ "Fig. 80-1") contains 2 RFID chips. Therefore, the rack handles may only be attached to the rack (→ "Fig. 80-2") after a possible microwave step for specimen preparation.
- If the slide racks should be transferred to a Leica CV5030 for coverslipping, a clip needs to be attached to the rack. This clip is for keeping the slides in a position that allows the Leica CV5030 to coverslip the slides. The clip should only be attached after the specimen rack has been removed from the HistoCore SPECTRA ST. Using the clip during the staining process can cause collisions within the device in all configurations, which can lead to damage to the slides and the samples.

Two different types of racks with compatible handles are available for use in the HistoCore SPECTRA ST stainer:

- Rack for 30 specimen slides for routine staining (→ "Fig. 80").
- Rack for 5 specimen slides for special staining (→ "Fig. 81").



Note

If a coverslipper from another manufacturer is used for coverslipping the HistoCore SPECTRA ST stained racks, the HistoCore SPECTRA ST offers the option of using racks from other manufacturers. These racks must be equipped with a rack handle produced by Leica and approved for this manufacturer. Racks from other manufacturers are generally transported to the unload drawer of the HistoCore SPECTRA ST after staining, and the user must remove them from there.

For available rack handles, see (→ P. 152 – Rack handles for racks from other manufacturers).

The colored handles must be correctly attached prior to using the rack in the instrument.

The rack handles must be attached corresponding to the previously defined program color (→ P. 65 – 5.9.1 Assigning a rack handle color to a staining program).

The specimen slide handles are available in 9 colors (8 program colors & white) (→ P. 150 – 9.2 Optional accessories).

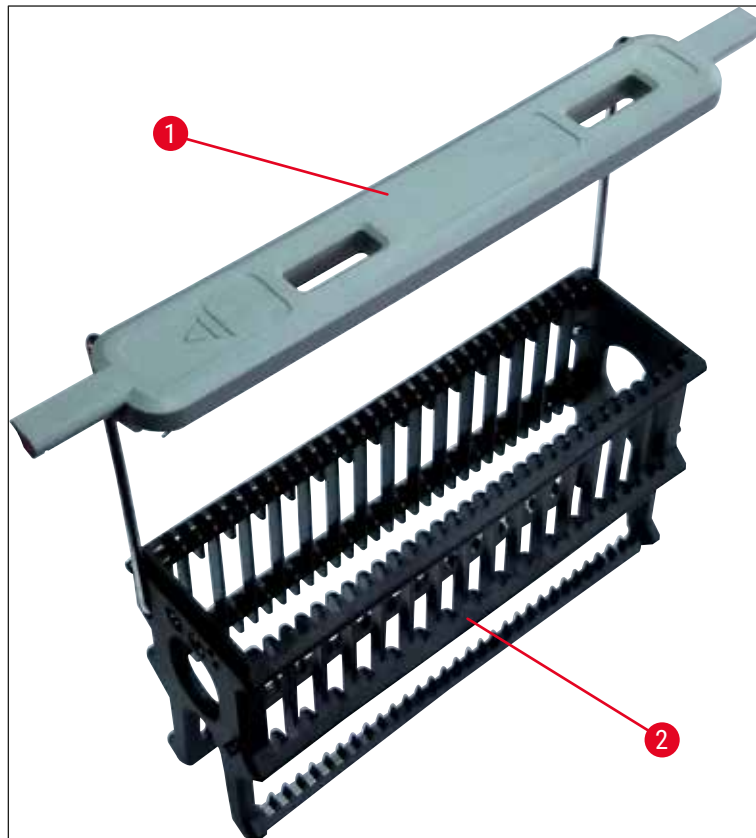

Fig. 80



Fig. 81

**Note**

The rack handle for 5 slides has a special coating that prevents chemical interactions with reagents for special applications (e.g. Prussian blue stain for iron detection, silver stains such as Grocott or Gomori). For more information about reagents that should be used with coated accessories, see (→ P. 163 – A1. Appendix 1 - Compatible reagents).

Special function of the white handle:

- The white handle cannot be permanently assigned to a staining program.
- Corresponding to a **WILDCARD FUNCTION**, the white handle must be reassigned to a program color each time the program is started.
- For this purpose, a selection menu opens on the screen automatically after inserting the rack.

Proceed as follows to attach or replace the rack handles:

Detach a handle from the rack:

- Slightly pull the handle apart (→ "Fig. 82"), so that the handle wire can be pulled out of the holes in the rack.

Attach a handle to the rack:

- Slightly pull apart the handle and lift on the rack so that the handle wire snaps into the respective holes on the left and right in the rack (→ "Fig. 82-1") (→ "Fig. 82-2").



Fig. 82

**Note**

- Be sure that the handle is correctly positioned in the upper position, centered above the rack (→ "Fig. 82").
- For stable placement for filling (→ "Fig. 83-3"), fold the handle (→ "Fig. 83-1") to the side as far as it goes (→ "Fig. 83-2") so it can be used as additional protection to prevent tipping.

6 Daily Instrument Setup

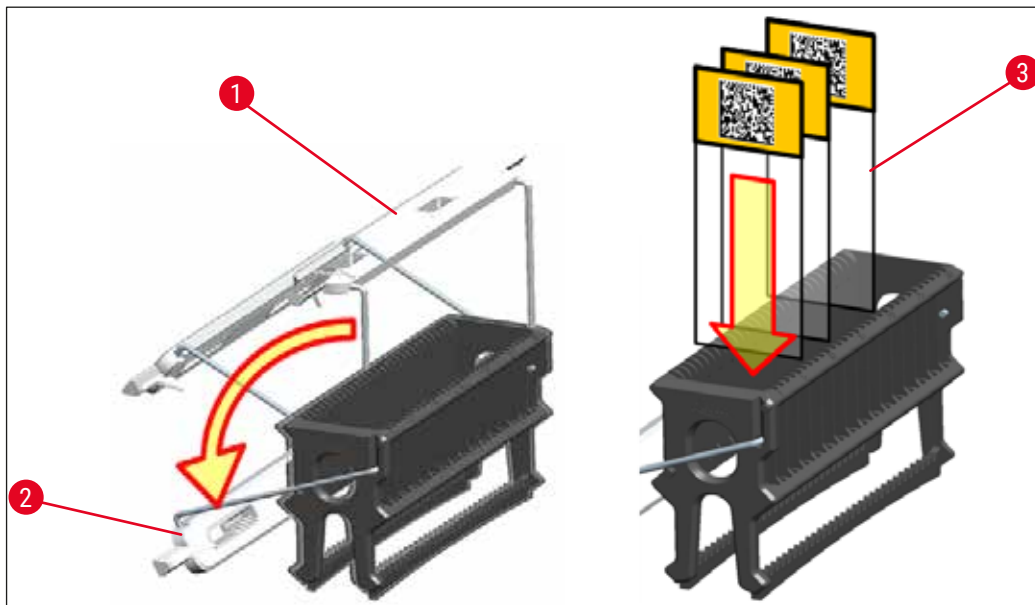

Fig. 83



Warning

- When inserting the specimen slides (→ "Fig. 83-3"), be absolutely certain that the slide label is facing upwards and toward the user. The side of the slide with the specimen absolutely must be facing the front side of the rack.
- The front side of the rack is labeled with the Leica logo. With the handle attached, **FRONT** can be read when looking at the handle (→ "Fig. 83").
- If the specimen slides are not inserted correctly, the samples can become damaged during the staining process.
- The stickers and/or labels used on the specimen slides must be resistant to the solvents used in the instrument.



Note

- Only specimen slides that meet the DIN ISO 8037-1 standard may be used with the 30-slide racks and 5-slide racks.
- When printable labels or handwritten labels are used on the rack handles and the specimen slides, they must be checked for solvent resistance prior to use.
- When inserting the specimen slide into the rack, you have to make sure that the slides are inserted into the respective rack for the desired staining program. The colored rack handles enable reliable assignment to the respective staining program.
- Make sure that only one specimen slide each is put into the insert space and that the slides are not jammed in.
- Extra-large slides with special size of 76 x 52 mm may therefore only be used in the recommended combination of optional Leica accessories (→ P. 152 – For special applications (extra-large slides)).

6.6 The staining process

The following requirements must be met to carry out the staining process:

- All settings have been optimized (parameters for oven, etc.).
- The programs required for staining have been created (→ P. 70 – 5.9.5 Creating or copying a new staining program).
- The reagent stations are filled with the correct reagents (→ P. 90 – 6.2.1 Preparation and handling of reagent vessels).
- A fill level scan has been carried out (→ P. 90 – 6.2 Daily instrument setup).
- The racks intended for staining are filled and the correct handles are attached to them (→ P. 101 – 6.5 Preparing the rack).



Note

Controlled shutdown of the instrument is initiated if the **operating switch** (→ "Fig. 13") is pressed during an ongoing staining process (→ P. 113 – 6.6.6 Finishing the daily operation). To do so, the user has to confirm shutdown of the instrument by pressing the **operating switch** twice.

6.6.1 Starting the staining process



Warning

- To avoid injuries, do not enter the movement area of the load drawer.
- The rack can be inserted only using the load drawer. Directly inserting it into any reagent or oven station by opening the instrument hood is not permitted. Racks inserted in this way cannot be recognized by the instrument and may cause collisions!
- Opening the hood when staining programs are active causes delays in the respective processing steps since no transport movements can take place during this time frame. This can result in changes to the staining quality.
- Make sure to keep the hood closed if the staining programs are active. Leica assumes no liability for loss of quality caused by this.
- If racks with white handles have been placed into the load drawer and assigned to a program, the program will have to be reassigned after the drawer and/or hood is opened again. For this purpose, observe the information messages displayed on the screen.

Starting the staining process

1. Fold the rack handle into the upright position (→ "Fig. 83").
2. If the load drawer is illuminated in green (→ "Fig. 84-1"), press it and open the drawer.
3. As shown in (→ "Fig. 84-2"), insert the rack into an available load drawer position.

6 Daily Instrument Setup



Fig. 84

4. Insert the rack so that both the Leica logo on the front side of the rack and the "Front" label on the top of the colored handle are pointing toward the user. The arrow on the top of the colored handle must point into the instrument.
5. Press the load drawer button again to close it again.
6. The user receives an information message if the load drawer is open for longer than 60 seconds.



Warning

Exercise caution when opening or closing the drawers. Crushing hazard! The drawers are motorized and open automatically when the button is pressed. Do not block the extension range of the drawers.

7. After the load drawer is closed, the instrument detects the RFID chip in the colored handle.
8. The detected handle color and the assigned program abbreviation are displayed in the bathlayout at the respective station (→ "Fig. 85").

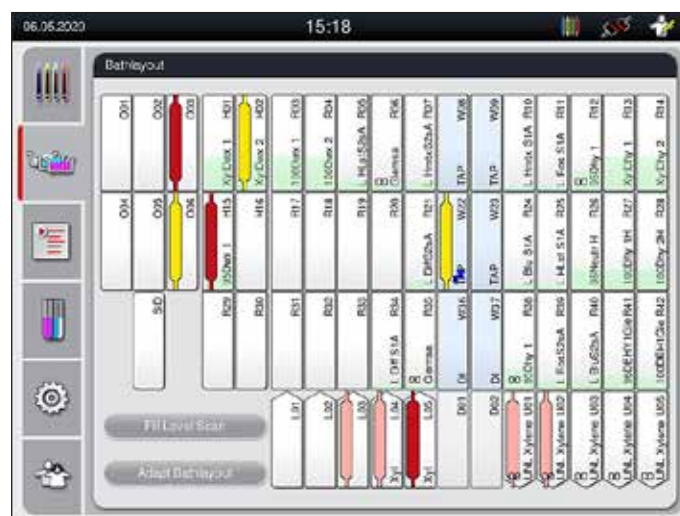

Fig. 85

**Note**

- The instrument detects and indicates when a rack has been inserted in the wrong orientation and has to be corrected by the user.
- If a rack has been inserted into the load drawer with a rack handle color for which no program is specified in the bathlayout (→ "Fig. 86"), the instrument detects this and informs the user by displaying an information message. The rack must be removed from the instrument. Corresponding to the bootable programs (→ P. 70 – Fig. 45), attach the correct colored handle to the rack and re-insert it into the load drawer.



Fig. 86

**Note**

For the inserted racks, the instrument calculates throughput-optimized start times that can deviate from the order of the inserted racks caused by the utilization of the step tolerances given in the specific program.

Due to the fact that the start times are optimized for throughput, a slightly different utilization of **DUPLICATED** reagent stations can occur.

- Before the first program step, the instrument counts the slides that have been inserted into the rack in the specimen slide counter station (→ "Fig. 3-2").
- The determined number of specimen slides is recorded and processed in the **RMS** and the consumption status of the respective reagents is updated.
- Afterwards, the rack is transported into an oven station or reagent station, depending on the defined first program step.

**Warning**

If the load drawer and hood of the instrument have been opened simultaneously before starting a staining process (e.g. for visual inspection of the reagents), the instrument issues an information message after 60 seconds that prompts the user to close the load drawer. If the rack is inserted before closing the load drawer, make sure that the hood is closed and the programs start.

If the programs do not start automatically, open the load drawer and close it once more.

6.6.2 Monitoring the staining process

Using the following menu, the user can call up or monitor details for ongoing programs:

- Bathlayout with station details (→ "Fig. 85").
- Process status display with calculated remaining program times and step times (→ P. 37 – 5.3 Process status display).
- The status bar (→ P. 36 – 5.2 Elements of the status display) with date, time and symbols that refer to information messages and warnings that occurred.



Note

The last 20 active information messages and warnings can be called up by touching the corresponding symbols in the status bar (→ "Fig. 16-2") (→ "Fig. 16-3"). This allows the user to learn about up-to-date situations after being absent from the instrument and to initiate any required actions.

6.6.3 Staining process finished

- After a rack has run through the staining process, it is transported into the unload drawer (→ "Fig. 19-4") and placed in an available position (→ "Fig. 87"). The user is informed of this by an information message and a signal tone.

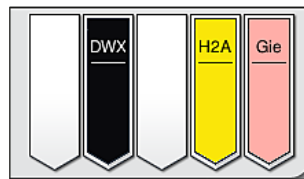

Fig. 87

- To remove the rack from the unload station, press the button on the unload drawer (→ "Fig. 19-4") to open it and remove the rack.
- Press the button again after removal to close the unload drawer.



Warning

- In the Process status display, the availability and the selected number of different unload stations is not visible to the user. It is recommended to use the Bathlayout menu for process monitoring (→ "Fig. 85") when using different reagents in the unload stations in order to be able to react early when the unload capacity is reached.
- If finished racks are not removed from the unload stations in due time, it may lead to interruptions in the staining process and may effect the staining results.
- To avoid injuries, do not enter the movement area of the unload drawer.
- The unload drawer must be opened and the racks must be removed no later than when the warning message is received indicating that the unload station is completely occupied (→ "Fig. 88"). Failure to comply with the warning message results in not being able to transport further racks into the unload stations. Deviating step times and delays in the staining process may change and ultimately invalidate the staining results.



Fig. 88

- The user receives an information message (→ "Fig. 89") if the unload drawer is open for longer than 60 seconds.



Fig. 89

**Note**

The warning message requests the user to close the unload drawer to prevent potential delays. When the unload drawer is open, the instrument cannot place completely processed racks into the unload stations. Deviating step times and delays in the staining process may change and ultimately invalidate the staining results.

- Press the button on the unload drawer for closing.

6.6.4 Canceling the staining program

**Note**

- Staining programs can only be canceled via the **process status display**.
- A program that is already in the specimen slide counter station (→ "Fig. 3-2") cannot be canceled.

1. To cancel a staining program, select the corresponding rack in the **process status display** (→ "Fig. 17-3") by touching it.
2. A list of program steps (→ "Fig. 90") appears; the current step is marked in red (→ "Fig. 90-1").

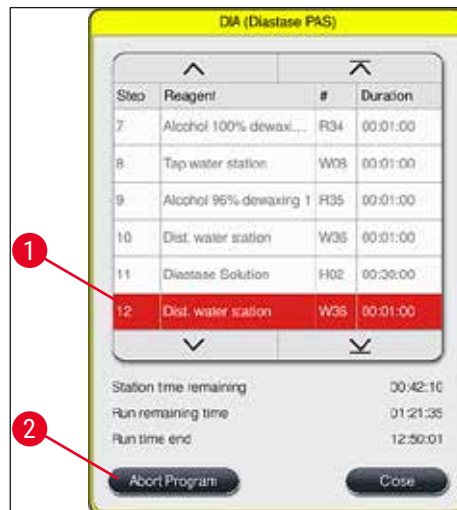

Fig. 90

- The frame of the window displays the color assigned to the program, the program name and the stored abbreviation.
- Press the **Abort program** (→ "Fig. 90-2") button.
- In the following information message (→ "Fig. 91"), confirm the program termination with the **Yes** button or return to the process status display with **No**.

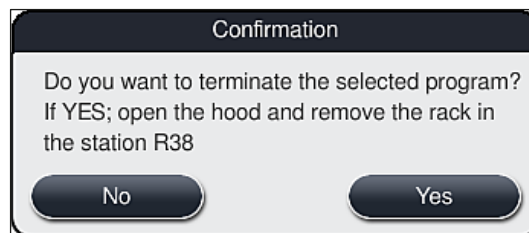

Fig. 91

**Note**

The information in the message (→ "Fig. 91") absolutely must be adhered to.

- The bathlayout is displayed after pressing the **Yes** button. The position of the rack in the instrument is marked orange (→ "Fig. 92-1").
- Open the instrument hood and remove the rack from the highlighted station.

**Warning**

If the marked station is an oven station, the left transport arm (→ "Fig. 3-1") may have to be shifted to the center of the instrument.

Do not touch or move the transport arm(s) at the sensor/antenna area (→ "Fig. 115-6")! Lift the metallic part of the gripper (→ "Fig. 115-1") manually and move the transport arm(s) carefully to the necessary position.

Then, pull the oven cover forward and remove the rack.

- Confirm the removal of the rack by pressing the marked station (→ "Fig. 92-1") and close the hood again.

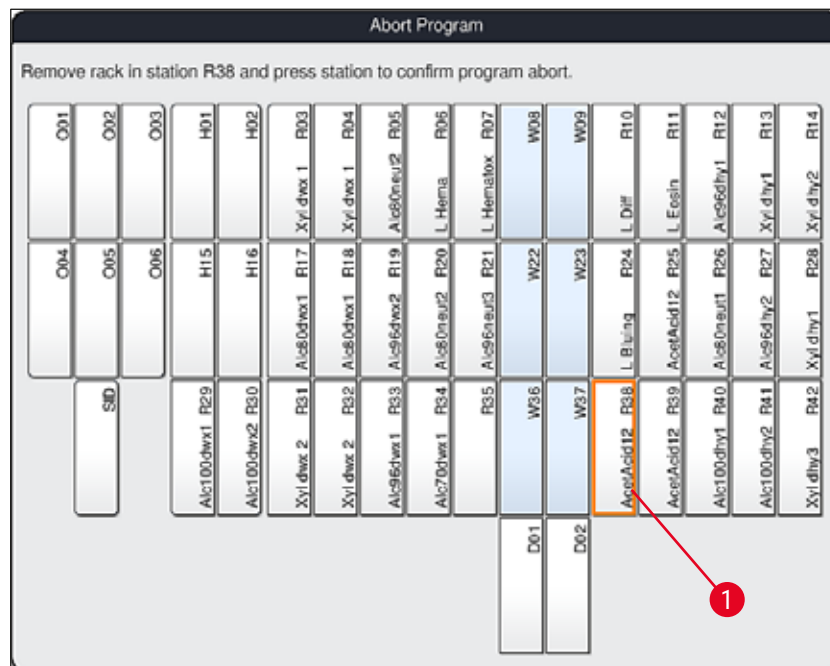

Fig. 92

**Warning**

- When removing the rack, proceed quickly and make sure that the hood remains open only for a short amount of time. After opening the hood, for safety reasons, all movements are interrupted until the hood is closed again. Deviating step times, delays and changed staining results can be caused each time the hood opens in the staining process.
- To avoid injuries, do not enter the movement range of the oven lid (swivel range of the oven).

**Note**

Remaining staining programs are continued after a program termination.

6.6.5 Operation as a workstation

The HistoCore SPECTRA ST can be operated as a workstation together with a HistoCore SPECTRA CV robotic coverslipper. This enables an interruption-free workflow from the staining process up to the removal of the finished coverslipped slides.

An optional transfer station is available for this purpose (→ P. 150 – 9.1 Optional instrument components).

**Note**

- The optional transfer station and connection of a HistoCore SPECTRA CV to the HistoCore SPECTRA ST may be installed subsequently only by a Leica-certified service technician.
- Any program must be programmed with a final target station. In the workstation mode, the transfer station is to be selected as the final step.
- When inserting a rack with a white handle, a program selection window opens in which a color program activated in the bathlayout has to be assigned to the white handle for this program only.
- If the transfer station is defined as the last station in the assigned program, the white rack must also be assigned to a suitable parameter set for the coverslipping process in the HistoCore SPECTRA CV. The user is also prompted to do so by a parameter selection window.

**Warning**

The user must adhere to the following in workstation mode!

- At least two unload stations of the HistoCore SPECTRA ST must be assigned to and filled with the same compatible reagent (**UNL Xylene**) as the load station(s) of the HistoCore SPECTRA CV.
- Filling the unload stations of the HistoCore SPECTRA ST and the load stations of the HistoCore SPECTRA CV with the same reagent is absolutely necessary, because the racks are conveyed into the unload station after the staining process in the event that the HistoCore SPECTRA CV is not available. This situation can occur if the reagent vessels of the load drawer of the HistoCore SPECTRA CV are already occupied by racks, the consumables have not been refilled in a timely manner or there is an instrument fault.
- If the HistoCore SPECTRA CV cannot temporarily accept any more racks from the HistoCore SPECTRA ST because the load drawer of the HistoCore SPECTRA CV is full, the racks are then be transported to the unload drawer of the HistoCore SPECTRA ST.
- In case of an instrument fault in the area of the transfer station of the HistoCore SPECTRA ST or if the load drawer of the HistoCore SPECTRA CV is not properly closed, the racks will be transported to the unload drawer of the HistoCore SPECTRA ST.
- In case of a persistent malfunction of the Transfer station, a reinitialisation should be tried after the staining processes have been finished. If this fails, the responsible Leica Service Organization must be notified.
- Racks for 5 specimen slides and 20 specimen slides cannot be transferred to the HistoCore SPECTRA CV. These racks are always put into the unload drawer at the end of the staining process, regardless of whether the transfer station has been specified in the staining program as the last station.
- If a white rack handle is used, the color of the staining program must be selected when inserting the rack into the load drawer. Following this, a second selection window opens, in which a parameter set must be selected for the HistoCore SPECTRA CV. The color of the parameter set in the HistoCore SPECTRA CV does not have to match the color of the selected staining program. If the HistoCore SPECTRA CV parameter set is not allocated, the rack is transported to the unload drawer of the HistoCore SPECTRA ST after staining. A note notifies the user about this.
- The operation as a workstation is described in detail in the Instructions for Use of the HistoCore SPECTRA CV.

**Warning**

If the specified stations are not filled as recommended, this can lead to damaged specimens with lower staining result quality and coverslipping quality. Not filling the specified stations may result in specimens being ruined from drying out.

6.6.6 Finishing the daily operation

After completing the daily staining operation, the instrument must be set to **standby** mode:

1. Check the following stations for remaining racks and remove them:
 - Load drawer (→ "Fig. 65-9")
 - Unload drawer (→ "Fig. 65-6")
 - Oven (→ "Fig. 65-1")
 - Dry transfer station (→ "Fig. 65-7")
 - Reagent vessel field (→ "Fig. 65-3"), (→ "Fig. 65-4"), (→ "Fig. 65-5") and (→ "Fig. 65-8")
2. Then cover all reagent vessels with the reagent vessel covers.
3. Push the green **operating switch** (→ "Fig. 9-2") once.
4. The instrument prompts the user to confirm the shutdown of the instrument by pressing the **operating switch** again.
5. After pushing the **operating switch** a second time, the instrument shuts down in a controlled manner.
6. The **operating switch** is now red and the instrument is in **standby** mode.
7. Finally, shut off the water supply.



Warning

- If cleaning or maintenance work are to be carried out on the instrument, the instrument must also be shut down at the **main switch** (→ "Fig. 9-1").
- To ensure a smooth operation of the instrument software, the instrument must be restarted by the user at least every 3 days. This applies to both HistoCore SPECTRA ST and HistoCore SPECTRA CV stand-alone units as well as in operation as a workstation. This also implies the HistoCore SPECTRA CV must be restarted by the user at least every 3 days.

7. Cleaning and Maintenance

7.1 Important notes about cleaning this instrument



Warning

General instructions:

- Before each cleaning, shut down the instrument using the **operating switch** (→ "Fig. 9-2") and then switch it off using the **main switch** (→ "Fig. 9-1").
- When cleaning the instrument, wear suitable protective clothing (lab coat and gloves) to protect from reagents and potentially infectious micro-biological contamination.
- Liquid must not come into contact with the electrical connections or get inside the instrument or in the housing below the transport arms.
- In case that the transport arm(s) must be lifted and moved, do not touch or move the transport arm(s) at the sensor/antenna area (→ "Fig. 115-6"). For this purpose lift the metallic part of the gripper (→ "Fig. 115-1") manually and move the transport arm(s) carefully to the necessary position.
- When using cleaning agents, observe the manufacturer's safety instructions and the laboratory regulations valid in the country of operation.
- Dispose of spent reagents in accordance with the laboratory guidelines in force in the country of operation.

The following applies to all instrument surfaces:

- Wipe up spilled solvents (reagents) without delay. The hood surface is only conditionally solvent-resistant at a longer exposure time!
- Do not use any of the following for cleaning the outside surfaces of the instrument: alcohol, detergents containing alcohol (e.g. window cleaner), abrasive cleaning powders, solvents containing acetone or xylene.

7.2 Exterior surfaces, varnished surfaces, instrument hood

The surfaces can be cleaned with a mild, pH-neutral, commercially available cleaning agent. After cleaning the surfaces, wipe them off with a cloth moistened with water.



Warning

Varnished instrument surfaces and plastic surfaces (e.g. the instrument hood) must not be cleaned with solvents such as acetone, xylene, toluene, xylene substitutes, alcohol, alcohol mixtures and abrasives! In case of long-term exposure, the surfaces and instrument hood are only conditionally resistant to solvents.

7.3 TFT touchscreen

Clean the screen using a lint-free cloth. A suitable screen cleaner can be used in compliance with the manufacturer information.

7.4 Interior and drain pan

- To clean the interior and the drain pan, remove the reagent vessels and rinsing water vessels.

Use a mild, pH-neutral, commercially available cleaning agent to clean these areas.

- After cleaning the drain pan, prime it thoroughly with water.

7.5 Transport arms

To clean the surfaces of the transport arms (→ "Fig. 93-1"), these are to be wiped off with cloth moistened with water or with a mild cleaning agent with a neutral pH value.



Warning

Ensure that no liquids spill underneath the housing (→ "Fig. 93-2") of the transport arms because there are sensitive parts here.

7.6 Specimen slide counter station

Check the recess and the sensors (→ "Fig. 93-4") of the specimen slide counter station for dirt and reagent residue. If specimen slides that already have damaged edges are used, small glass shards and splinters may have collected there (→ "Fig. 93-3"). Therefore, all debris in this area must be carefully removed to prevent injury. Clean the sensors with a lint-free cloth if they are covered with reagent residues.



Warning

Wear suitable protective clothing (lab coat and gloves) to protect against cutting injuries.

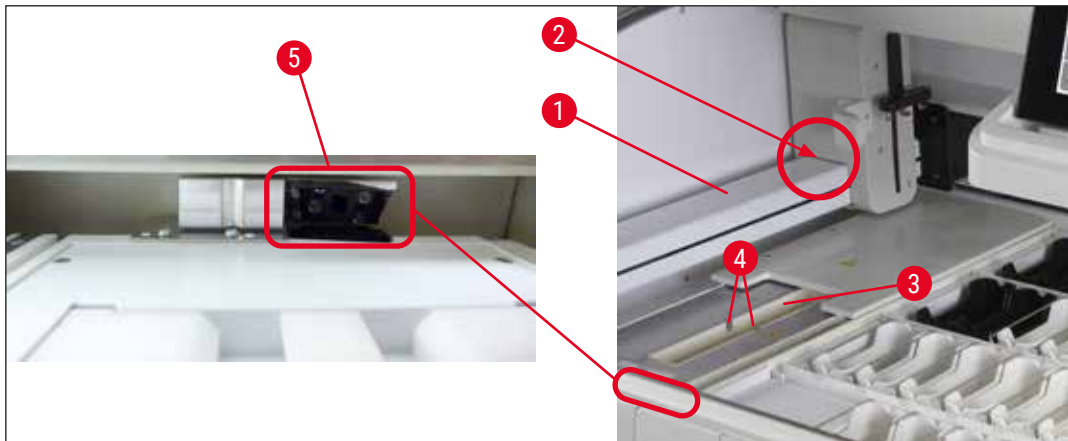

Fig. 93



Warning

Do not pour the alcohol directly on the plastic window.

7.7 Load and unload drawers

- Remove reagent vessels from both drawers and store them outside of the instrument.
- Check the inside of the drawers for reagent residue and remove residue where appropriate.
- Finally, insert the reagent vessels into the correct positions again.
- Observe the existing labeling (→ "Fig. 94-1") for stations in the drawers.

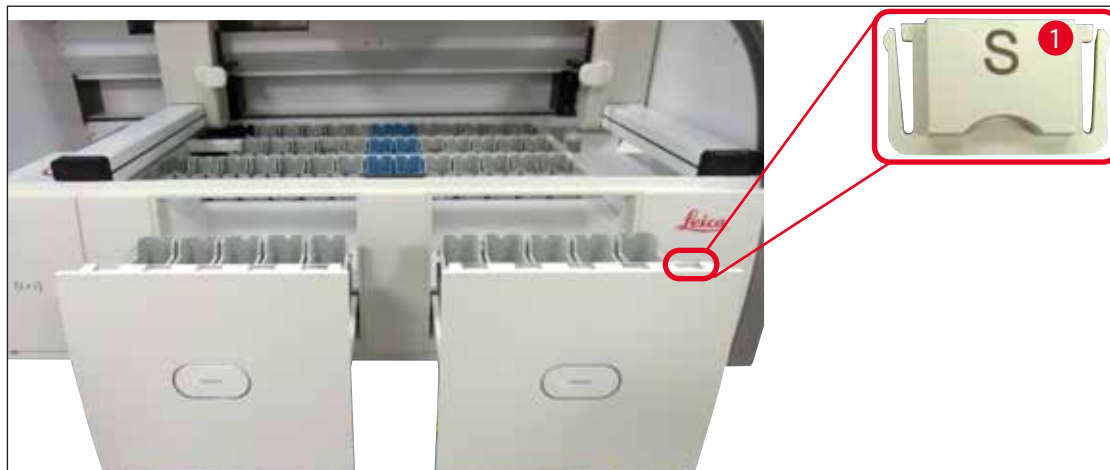

Fig. 94



Note

Use the label covers contained in the (→ P. 20 – 3.1 Standard delivery) to label the reagent vessels in the load and unload drawers. The imprinted letters have the following meanings:

- H₂O = water or distilled water
- A= alcohol
- S = solvent, for example, xylene

7.8 Dry transfer station

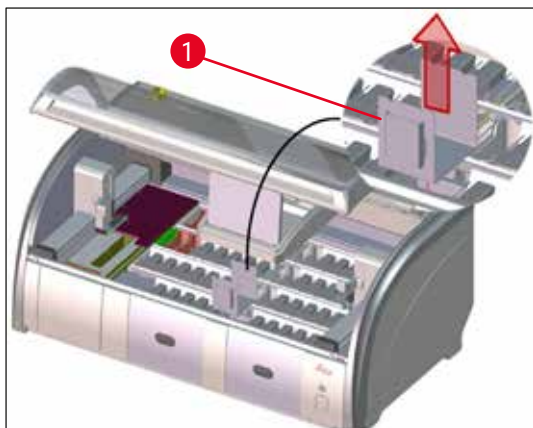

Fig. 95

After inserting the dry transfer station, the reagents can drip down. This residue must be removed regularly.

- To do so, remove the insert (→ "Fig. 95-1") of the dry transfer station by pulling upwards, check for contamination and clean if necessary.
- Then, re-insert the insert and make sure it snaps in correctly.

7.9 Transfer station (optional)

- Regularly check the transfer station (→ "Fig. 96") for reagent residue and, if necessary, clean it using a commercially available, mild cleaning agent with a neutral pH value.

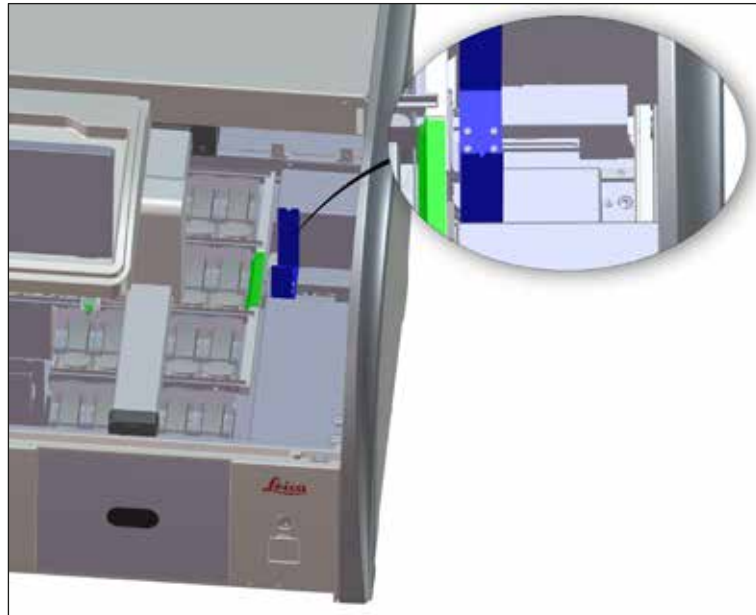

Fig. 96

7.10 Reagent vessels and rinsing water vessels

Generell

- Remove the vessels individually from the handle. Ensure that the handle is in the correct position (→ P. 90 – 6.2.1 Preparation and handling of reagent vessels) to prevent spilling of the reagent.
- Dispose of reagents in accordance with the local laboratory specifications.
- Reagent and rinsing water vessels can be cleaned in a dishwasher, at a maximum temperature of 65 °C, using a standard, commercially available detergent for lab dishwashers. The handles can remain attached to the various vessels during this process.
- The O-ring (→ "Fig. 97-1") must remain attached to the rinsing water vessel.



Warning

- Never clean plastic reagent vessels at temperatures higher than 65 °C since this can deform reagent vessels.

Reagent vessels



Warning

- To prevent damage to the coating of coated accessories (inserts for special stainings and specimen slide handles for 5 specimen slides), these must not be cleaned in a dishwasher. Likewise, make sure the coating does not get damaged when cleaning manually. If coated accessories are damaged, they may cause chemical reactions with reagents for special applications (→ P. 163 – A1. Appendix 1 - Compatible reagents).
- Color reagent vessels have to be pre-cleaned by hand before cleaning in a dishwasher. Remove as much staining residue as possible to avoid discoloring the remaining reagent vessels in the dishwasher.
- If the cleaned and filled reagent vessels are to be put back into the instrument, they need to be put in the correct position in accordance with the displayed arrangement of the bathlayout (→ P. 77 – 5.9.9 Executing the bathlayout). To do so, switch on and initialize the instrument.

Rinsing water vessels

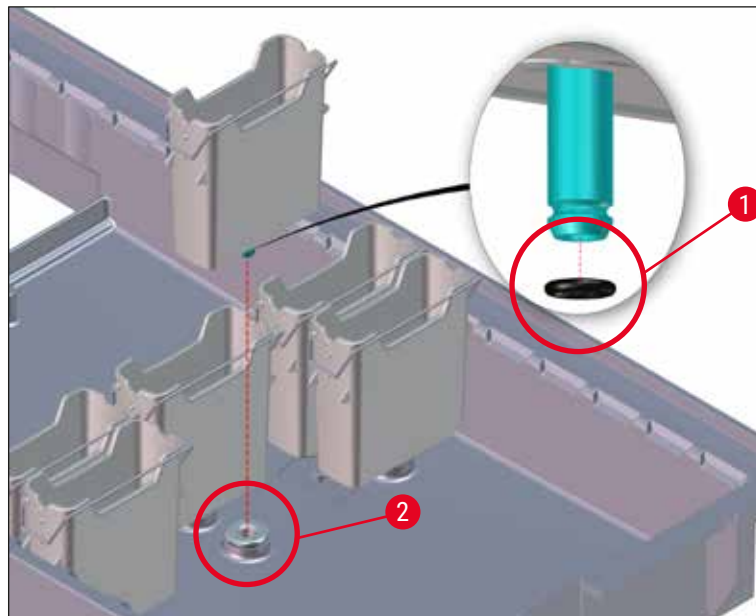

Fig. 97

**Warning**

- Do not reinsert rinsing water vessels without O-ring or with a damaged O-ring! If an O-ring cannot be replaced immediately, the affected rinsing water vessel must be removed from the instrument.
- In this case the user must start the **Fill Level Scan**. The software detects the missing vessel and marks it as defective. If only 1 or 2 rinsing water vessels are affected, programs that contain a rinsing water step can still be started.
- If the two front rinsing water cuvettes are defined as DI water and one of the two fails, there may be delays in programs that contain a DI water step. If both rinsing water vessels had to be removed, programs that contain a DI water step cannot be started!
- Replace the missing/defective O-ring (s) and grease with Molykote111. Put the rinsing water vessel(s) back into the device and start the **Fill Level Scan** again. The software recognizes that the rinsing water vessel(s) is/are ready for use again.

**Note**

- The rinsing water vessels are to be regularly checked for calcification, visible, microbiological deposits of bacteria, fungi, algae and permeability. Lime residue can be removed using a mild vinegar-based cleaning solution. Finally, rinse off the vessels with clear water until the cleaning agent residue has been removed. O-rings (→ "Fig. 97-1") need to be checked for damages. Replace damaged O-rings with new ones (→ P. 150 – 9.2 [Optional accessories](#)).
- After cleaning the rinsing water vessels and before inserting them into the instrument again, the connecting piece to the water inlet system must be checked for correct positioning on the O-ring (→ "Fig. 97-1").
- If O-rings are left in the instrument when removing a rinsing water vessel (→ "Fig. 97-2"), remove them carefully with pincers and stick them back onto the connection port.
- If an O-ring is missing or positioned incorrectly, the rinsing water vessels must not be put back into position after cleaning, because otherwise there is a danger of the priming function being defective during the staining process.
- After attaching or correcting the position of the O-ring, lubricate it with the Molykote 111 grease included in the (→ P. 20 – 3.1 [Standard delivery](#)).
- Then the rinsing water vessels can be put back into their position.

7.11 Rack and handle

- The rack is to be checked regularly for staining residue and other possible contamination.
- The colored handle must be removed from the rack for cleaning.
- To remove staining residue from the racks, immerse it in a bath of lukewarm water and a mild, pH-neutral lab cleaner and let the cleaner take effect. When doing so, carefully observe the additional manufacturer information regarding cleaning agents and the recommended application area.
- Then, strong staining contamination can be removed using a brush.
- Now, take your time to thoroughly prime the racks with fresh water until no more staining and cleaning agent residue remains on them.
- If residue from the mounting medium remains on the racks, these can be placed in a bath of solvent.



Warning

The racks and handles must not remain in the solvent for a long time (e.g. several hours or overnight), because this can lead to deformation!

It is essential to ensure that the solvent being used is compatible with the mounting medium. Xylene or toluene-based mounting media can be removed using a xylene bath. Xylene substitute-based mounting media can be removed using a bath containing a corresponding xylene substitute.



Note

The maximum exposure time in a solvent bath is 1-2 hours. The solvent can be washed off with alcohol. Completely prime the racks with water, then dry them. If an external drying oven is used for drying, the temperature must not exceed 70 °C.

7.12 Water drainage



Warning

The draining system within the instrument must be regularly cleaned and checked for correct flow. If this measure is not completed, the water draining system must become clogged, which could lead to interruptions or malfunctions in the staining process.

- To clean the water draining system, remove the 4 rear rinsing water vessels (→ "Fig. 65-4") and all surrounding reagent vessels.
- The remaining reagent vessels have to be covered with lids.
- Remove the drainage sieve and clean it if necessary (→ "Fig. 98-1").
- Place one to two cleaning tablets with active oxygen (e.g. a denture cleanser) into the drain and dissolve in water to remove various residue (reagents, bacteria, fungi, algae).
- Then, clean the entire curved drainage area inside the instrument with a long, flexible brush (→ "Fig. 98-2").
- Check the flow by flushing thoroughly with water.
- Insert the drainage sieve again, and put the vessels back in their original, defined positions.

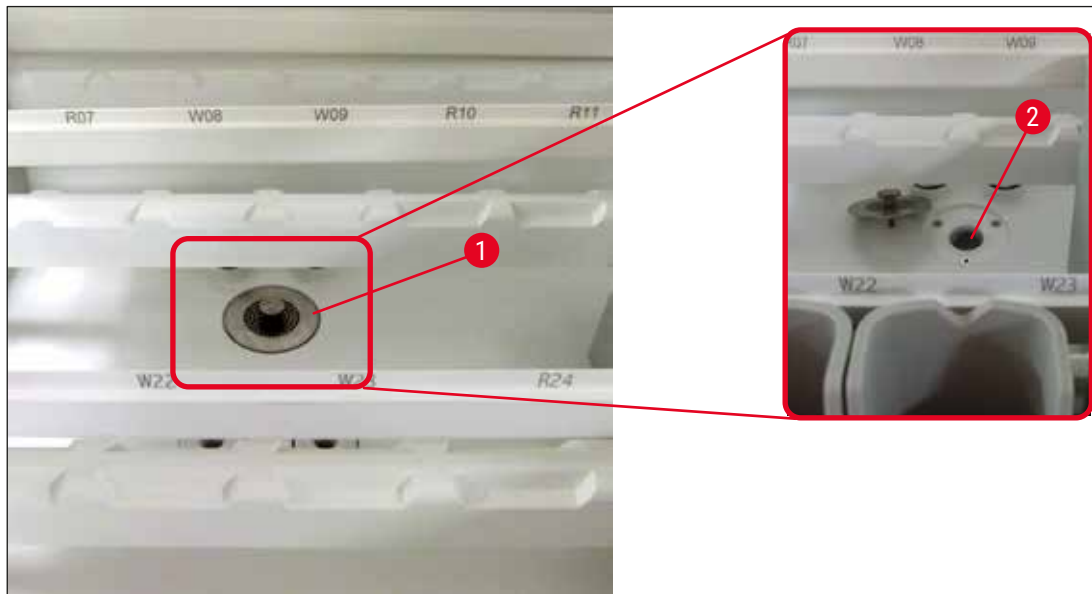

Fig. 98

7.13 Water drain hose

The water drain hose must be checked once a year by a service technician authorized by Leica.

7.14 Replacing the filter cartridge of the water intake filter



Warning

The housing of the water intake filter is not solvent-resistant and can therefore become brittle and break. Do not use any alcohol or detergents containing alcohol for cleaning the water filter housing (→ "Fig. 99-2"). The consequence could be that water leaks in an uncontrolled manner and damages the laboratory and the laboratory environment.

The water intake filter with filter cartridge should be checked and replaced once a year by a service technician authorized by Leica.

The integrated water intake filter (→ "Fig. 99") protects instrument's internal water circuit components from damage due to sediments and mineral deposits.

The water filter durability depends on the water quality at the installation location. The maximum lifetime of the water filter is 1 year.

The water intake filter should therefore be checked regularly by looking through the filter housing for visible debris.

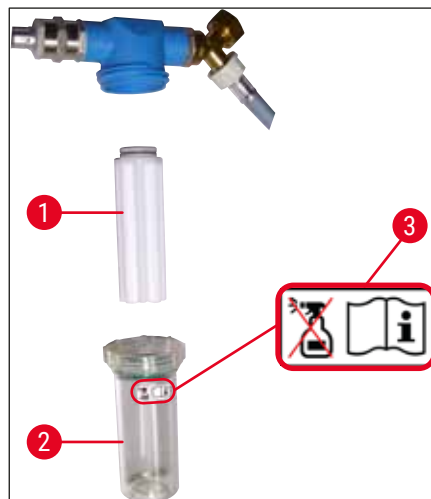

Fig. 99

- 1 Filter cartridge, Order No. 14 0512 49332
- 2 Filter housing
- 3 Warning label: Do not use any kind of alcohol for cleaning and observe the Instructions for Use

**Note**

If a significant amount of debris is visible in the water filter before the maintenance interval (1 year) expires, it must be replaced by a Leica service technician.

7.15 Changing the active carbon filter

The active carbon filters (→ "Fig. 1-1") installed in the instrument help reduce the amount of reagent vapors in the exhaust air. The life cycle of the filter can fluctuate strongly depending on intensity of use and the reagent configuration of the instrument. Therefore, replace the active carbon filter regularly, but at least every three months, and dispose of it properly in accordance with the laboratory regulations applicable in the country of operation.

- The filter unit consists of two individual filter elements (→ "Fig. 100-1"), which are accessible to the user on the front of the instrument.
- They can be accessed without tools and removed by pulling on the pull tabs (→ "Fig. 100-2").
- Insert the new filter elements so that the pull tabs can be reached after they are inserted fully and the article number (→ "Fig. 100-3") printed on them is legible.
- Note the insertion date for the filter element on the white label and stick the label on the left or right side of the active carbon filter (→ "Fig. 100-4").
- Both active carbon filters must be pushed in until you feel them make contact with the rear panel of the instrument.



Fig. 100

**Warning**

If inserted incorrectly, the active carbon filters can protrude into the range of movement of the two transport arms, thereby impeding or interrupting the staining process.

7.16 Cleaning the ovens**Warning**

- Beware of hot surfaces: After using the oven in the staining process, first shut the instrument down before cleaning it and wait at least 10 minutes for it to cool off. Only hold the oven inserts at the described positions.
- The interior of the oven must not be cleaned using solvents, as there is a risk that solvent residues will get into the oven and evaporate in the oven when the process begins.

Regularly check for dirt on the sheet metal inserts for catching paraffin residue in the oven.

- Manually pull the movable oven cover (→ "Fig. 101-1") towards the front of the instrument. The oven cover should not be folded up to the side.
- If necessary, carefully shift the left transport arm to the side, so that the oven insert can be easily accessed.



Warning

In case the transport arm(s) must be lifted and moved, do not touch or move the transport arm(s) at the sensor/antenna area (→ "Fig. 115-6"). For this purpose lift the metallic part of the gripper (→ "Fig. 115-1") manually and move the transport arm(s) carefully to the necessary position.

- First grab the front oven insert (→ "Fig. 101-2") by the sides and lift it upwards out of the instrument, then remove the rear oven insert (→ "Fig. 102-2").
- Disconnect the two oven chambers by pulling them up in opposite directions.
- You can then pull out the insert for catching paraffin residue from the respective oven insert (→ "Fig. 102-3") and (→ "Fig. 102-4").
- Check the sheet metal inserts for paraffin residue and dirt and clean them. To melt the paraffin, the inserts can be placed in an external laboratory oven.
- After heating, wipe off the paraffin residue with a lint-free cloth.
- Check the ventilation flaps in the oven chambers for proper function. If they are visibly dirty, carefully clean them with a lint-free cloth.
- Push the sheet metal inserts back into the respective oven insert in the correct orientation (perforated side facing up).
- After cleaning, first put the rear oven insert (→ "Fig. 102-2") back into the instrument in the correct position and then put back the front oven insert (→ "Fig. 101-2"). Observe the correct positioning of the connected oven inserts.

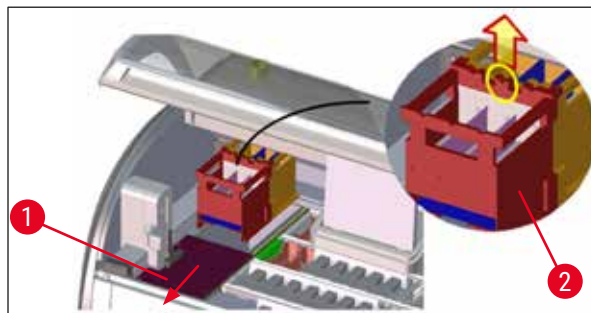

Fig. 101

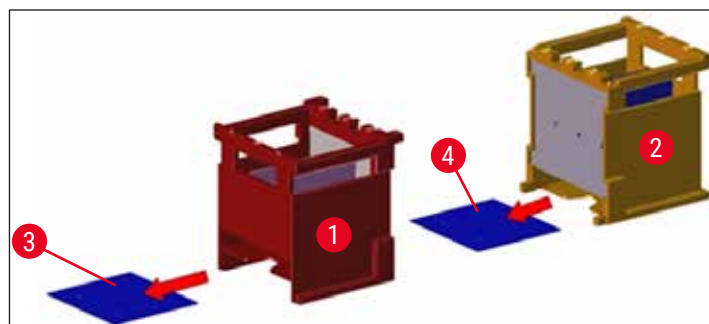

Fig. 102

7.17 Oven air filter

The air filter of the oven should be regularly checked, cleaned or replaced.

- To do so, remove the filter insert (→ "Fig. 103-1") and shake it out or replace it with a new filter insert (→ P. 150 – 9.2 Optional accessories).
- After checking and cleaning, re-insert into the oven in the same way.

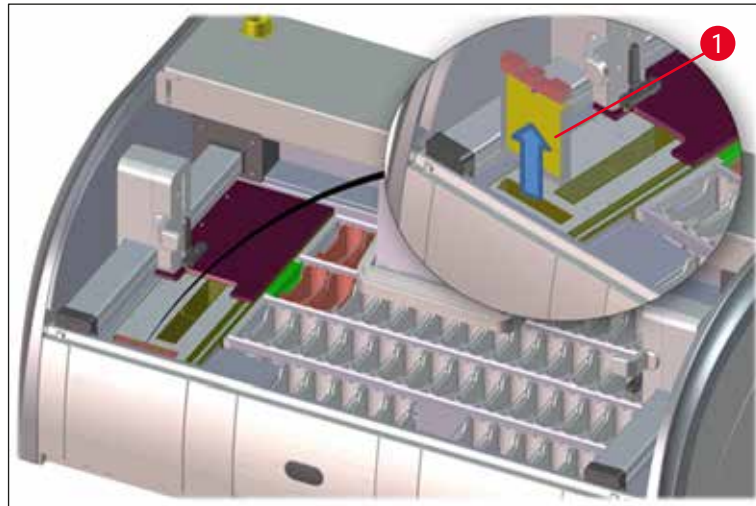

Fig. 103



Note

The installation is carried out in reverse order.

7.18 Maintenance and cleaning intervals



Warning

- You must carry out the maintenance and cleaning tasks listed below.
- The instrument must be inspected once per year by a qualified service technician authorized by Leica in order to ensure the continuous functional capability of the instrument.

To ensure trouble-free operation of the instrument over a long period of time, the following is strongly recommended:

- At the end of the warranty period, enter into a service contract. For more information, contact the relevant customer service organization.

7 Cleaning and Maintenance

7.18.1 Daily cleaning and maintenance



Warning

If sensitive instrument parts and areas get very dirty or if reagents are spilled, they must be cleaned immediately, as a reliable workflow is not guaranteed otherwise.

- 1 Checking and filling/refilling the reagent vessels. (→ P. 90 – 6.2.1 Preparation and handling of reagent vessels)
- 2 Covering the reagent vessels and, if necessary, storing them with covers in a refrigerator.
- 3 Checking the rack and handles for paraffin or staining residue and broken glass. (→ P. 119 – 7.11 Rack and handle)
- 4 Check the complete specimen slide counter station for reagent residue and dirt and clean it if necessary. (→ P. 115 – 7.6 Specimen slide counter station)
- 5 Check the surface in the area of the load and unload drawers for solvent residue and clean it if necessary. (→ P. 116 – 7.7 Load and unload drawers)
- 6 Clean the insert of the dry transfer station and clean if necessary. (→ P. 116 – 7.8 Dry transfer station)
- 8 Check the transfer station (optional) for reagent residue and clean it if necessary. (→ P. 117 – 7.9 Transfer station (optional))

7.18.2 Cleaning and maintenance as necessary

- 1 Clean the screen using a lint-free cloth. A screen cleaner can be used according to manufacturer instructions. (→ P. 114 – 7.3 TFT touchscreen)
- 2 Clean outer/painted surfaces. (→ P. 114 – 7.2 Exterior surfaces, varnished surfaces, instrument hood)
- 3 Clean the instrument cover. (→ P. 114 – 7.2 Exterior surfaces, varnished surfaces, instrument hood)
- 4 To ensure a smooth operation of the instrument software, the instrument must be restarted at least every 3 days. (→ P. 113 – 6.6.6 Finishing the daily operation)

7.18.3 Weekly cleaning and maintenance

- | | | |
|----------|--|---|
| 1 | Check/clean the rinsing water vessels for bacterial contamination. Make sure the O-rings are in place and undamaged. Damaged O-rings must be replaced with new ones. | (→ P. 117 – 7.10 Reagent vessels and rinsing water vessels) |
| 2 | Clean the reagent vessels. | (→ P. 117 – 7.10 Reagent vessels and rinsing water vessels) |
| 4 | Clean the racks and handles. | (→ P. 119 – 7.11 Rack and handle) |
| 5 | Check the water drain and sieve within the instrument for proper function and clean it if necessary. | (→ P. 120 – 7.12 Water drainage) |
| 6 | Checking transport arms for dirt and clean if necessary. | (→ P. 115 – 7.5 Transport arms) |

7.18.4 Monthly cleaning and maintenance

- | | | |
|----------|--|---|
| 1 | Check the water intake filter (look through filter housing). | (→ P. 121 – 7.14 Replacing the filter cartridge of the water intake filter) |
| 2 | Check, clean or, if necessary, replace the air filter of the drying oven with a new one. | (→ P. 150 – 9.2 Optional accessories)
(→ P. 125 – 7.17 Oven air filter) |
| 3 | Cleaning the drip tray. | (→ P. 114 – 7.4 Interior and drain pan) |
| 4 | Checking the drying oven insert and catch tray for paraffin residue and cleaning it. | (→ P. 123 – 7.16 Cleaning the ovens) |

7.18.5 Cleaning and Maintenance Every Three Months

- | | | |
|----------|------------------------------------|---|
| 1 | Changing the active carbon filter. | (→ P. 122 – 7.15 Changing the active carbon filter) |
|----------|------------------------------------|---|

7.18.6 Annual cleaning and maintenance

- | | |
|----------|---|
| 1 | Checking and maintenance of the instrument by a service technician authorized by Leica. |
|----------|---|

8. Malfunctions and Troubleshooting

8.1 Fault remedies for instrument malfunctions

Error/problem

Rising water level in the drain pan with alarm.

Cause

Water drain partially or completely blocked

Water drainage system inside the instrument and/or the drainage sieve partially or completely blocked.

Troubleshooting

Checking and maintaining the water drain hose (→ "Fig. 7-1"). For this purpose, contact the responsible Leica service.

Checking and maintaining the water drain system in the instrument.

Observe the cleaning instructions in the (→ P. 125 – 7.18 Maintenance and cleaning intervals).

If the blockade remains, the water inflow to the rinsing water vessels is stopped and the staining process is interrupted. Therefore, the specimens have to be removed from the instrument and put into a safe position or temporary storage (→ P. 131 – 8.2 Power failure scenario and instrument malfunction).

Decreased priming during the staining cycles with possibly inconsistent staining results.

Water inlet in rinsing water vessels attenuated/blocked.

Possible causes:

- Rinsing water vessels fit incorrectly (rinsing water vessel connector broken or O-ring damaged).
- Calcification of the rinsing water vessel.

Monitoring and maintaining the rinsing water vessels.

Observe the cleaning instructions (→ P. 117 – 7.10 Reagent vessels and rinsing water vessels), check O-ring and rinsing water vessel connector.

Observe regular maintenance intervals.

Rinsing water vessels do not drain automatically during breaks in operation of the instrument. Standing water can be a source for microbiological contamination in the rinsing water vessel and the samples.

The additional water drain hole at the base of the rinsing water vessels is blocked by calcification/dirt.

Monitoring and maintaining the rinsing water vessels.

Observe the cleaning instructions (→ P. 117 – 7.10 Reagent vessels and rinsing water vessels).

Observe regular maintenance intervals.

Error/problem	Cause	Troubleshooting
Insufficient flushing during the staining processes may yield inconsistent staining results.	Water pressure too low in the intake drainage system of the lab or fluctuations at different times of the day.	The specified minimum requirements for water pressure (→ P. 21 – 3.2 Specifications) must be fulfilled (even in the event of possible deviations during the daytime).
Reagent vessels are deformed.	Use of reagents that are not permitted (ex. phenol in Ziehl-Neelson staining or Gram staining, etc.). Incorrectly applied cleaning procedure.	Monitoring the used reagents using the list of permitted reagents (→ P. 163 – A1. Appendix 1 - Compatible reagents). Observe the cleaning instructions (→ P. 117 – 7.10 Reagent vessels and rinsing water vessels).
Inconsistent staining results	The tolerance of the program step for staining reagents is not correctly defined.	Inspecting the staining programs and reagents. Most short program steps demand exact compliance with the staining step. The tolerance of the reagent must be set to 0 %.
Varying staining results	The process classes (paraffin removal, staining, etc.) for reagents have not been correctly assigned. This means that the bathlayout might not have been optimally executed. Reagents that are only to be used by one program are used by other programs. The reagent was dirty because it was not programmed as " Exclusive ".	Inspection and correction of the assigned reagent classes (→ P. 59 – Creating a new reagent or copying a reagent). Inspecting and correcting the programming of respective reagents.
Insufficient staining quality	Water quality does not comply with: <ul style="list-style-type: none"> • ISO 3696: 1995 Type 3/ASTM D1193-91 Type IV • Drinking water quality, in accordance with applicable official regulations Inappropriate, acidic pH value of the connected water supply can influence the staining reaction and may lead to deviating staining results.	Test the water quality in accordance with ISO 3696: 1995 Type 3/ASTM D1193-91 Type IV and adjust the water quality if necessary. If the problem still persists, contact your local Leica service and application support to discuss further options for installation and protocol adaptations.

Error/problem	Cause	Troubleshooting
Insufficient water quality affects rinsing function in water vessels (instrument parts may be damaged)	Water quality does not comply with: <ul style="list-style-type: none"> • ISO 3696: 1995 Type 3/ASTM D1193-91 Type IV • Drinking water quality, in accordance with applicable official regulations 	Test the water quality in accordance with ISO 3696: 1995 Type 3/ASTM D1193-91 Type IV and adjust the water quality if necessary. If the problem still persists, contact your local Leica service and application support to discuss further options for installation and protocol adaptations.
After drying, tissue does not adhere well enough to the specimen slide, and floats away during the staining process.	Acidic pH value may damage instrument parts made of stainless steel	Inspecting and correcting information about firing time and oven temperature for customer-defined programs.
The staining processes are finished, but repeated or additional programming (supervisor mode) cannot be completed.	For customer-defined programs, the selected firing time and oven temperature (or both) are too low. Programming can only be completed when the instrument is in sleep mode; in other words, no racks may be in progress; this also includes the unload drawer positions.	Remove racks from the unload drawer, then carry out programming.
Initialization of the instrument cannot be completed.	Arms are blocked.	Check that the active carbon filter is in the correct position.
The automatic fill level scan shows incorrect results.	Inserted reagent vessel clips protrude over the reagent vessel and are incorrectly interpreted in the fill level scan.	Check the proper placement of the reagent vessel clip and, if necessary, correct it.
The automatic fill level scan shows incorrect results for the load drawer stations and/or the dry transfer station. Individual stations are reported as "Missing".	Deposits on the bottom of the empty reagent vessel and/or dry transfer station influence the measuring methods of the automatic fill level scan.	Clean the reagent vessels and/or the dry transfer station and remove any clinging lime residue. Then, repeat the fill level scan (→ P. 92 – 6.2.2 Automatic fill level scan).



Note

Display messages for certain failures contain image sequences to guide the user through the troubleshooting process (→ "Fig. 120").

8.2 Power failure scenario and instrument malfunction



Note

- For the event of a short-term power failure (in the range of a few seconds), the HistoCore SPECTRA ST has an internal UPS (uninterruptible power supply). The user is notified in the event of a short-term power failure via an information message on the screen. The information message goes away as soon as the power supply is restored. The event is entered into the event log.
- Circumventing longer-term power failure is possible only by using an external UPS (→ P. 32 – 4.3.1 Using an external uninterruptible power supply (UPS)).

In the event of a longer-term power failure (lasting > 3 seconds), the instrument shuts down. The event is entered into the event log.

The internal UPS ensures that transferable racks are placed in a secure position above two reagent stations (→ "Fig. 104") to prevent unintentional lowering into an incompatible reagent.



Warning

Reagent displacement can occur as a result of clinging reagents when setting aside a rack. The affected reagent vessels are to be checked for debris before starting a staining process and replaced if necessary (→ P. 100 – Reagent replacement).



Fig. 104

The instrument restarts as soon as the power supply is restored.

During initialization, the instrument software issues a series of messages and instructions to the user, which provide him/her with information about the power failure and instruct him/her regarding how to proceed.

The user can cancel or resume the staining process software using the displayed assistance.



Warning

Racks in critical positions must immediately be removed from the instrument by the user.

The reagent stations defined as "critical" positions are those at which excessively long dwell times may lead to the deterioration of the staining quality or to sample destruction.

Critical positions:

- » Rinsing water (→ "Fig. 105-1") and DI water stations (→ "Fig. 105-2")
- ① Vessels can be drained and the specimens can dry out through continuous, automatic water draining on the floor of the vessel. The specimens are to be removed from the instrument and stored securely outside of the instrument, i.e. the staining process is to be completed manually.
- » Dry transfer station (→ "Fig. 105-3")
- ① The specimen are not located in a reagent and could dry out. The specimens are to be removed from the instrument and stored securely outside of the instrument, i.e. the staining process is to be completed manually.
- » Specimen slide counter station (SID) (→ "Fig. 105-4")
- ① In the event of power failure, a rack inserted into the specimen slide counter station is placed in a secure location between two reagent stations (→ "Fig. 104"). Remove the rack as described (→ P. 139 – 8.2.4 Detaching a rack from the gripper mechanism) and re-insert it into the load drawer.
- » Oven stations (→ "Fig. 105-5")
- ① A drop in temperature in the oven station can occur during longer-term power failure. This could result in specimens that have not dried properly. The affected racks are to be removed from the oven and reinserted into the load drawer.
- » Transfer station (→ "Fig. 105-8")
- ① The specimens are not located in a reagent and could dry out. The specimens are to be removed from the instrument and stored securely outside of the instrument or manually inserted into the load drawer of the HistoCore SPECTRA CV to be coverslipped.

**Warning**

The user is to check whether additional racks are present in the remaining reagent stations (→ "Fig. 105-6") where excessively long dwell times may lead to a loss in staining quality due to the reagent used at those specific stations. The specimens are to be removed from the instrument and stored securely outside of the instrument, i.e. the staining process is to be completed manually.

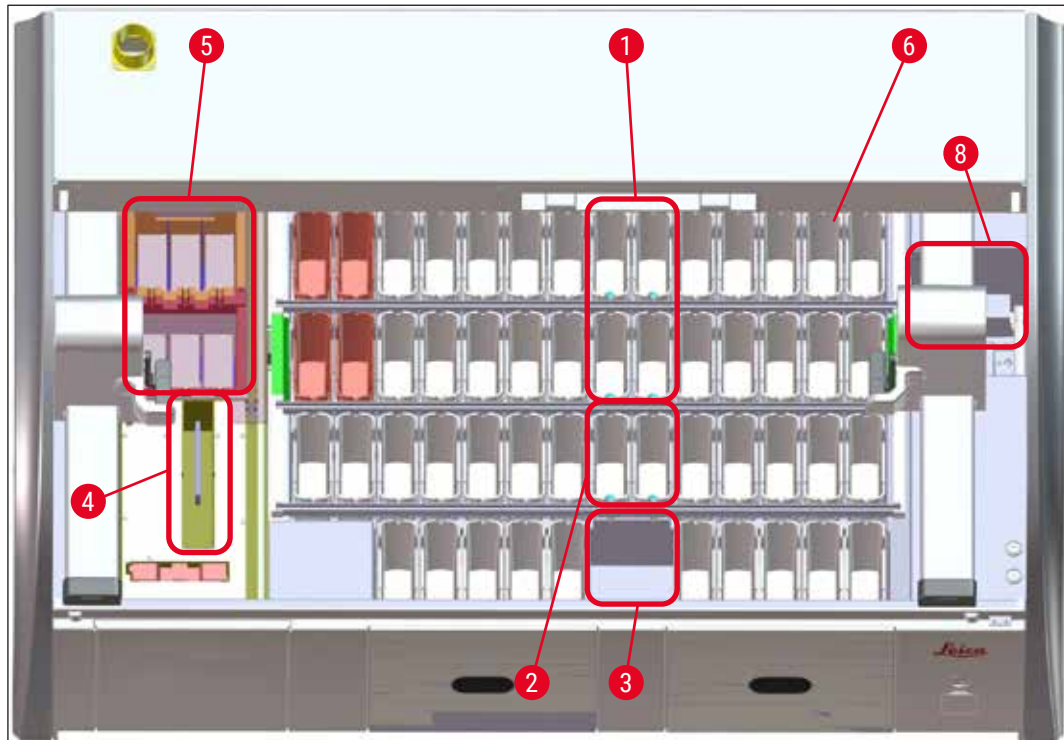

Fig. 105

8.2.1 Procedure after a power failure

- ① The first information message after the instrument restarts automatically notifies the user of the power failure time (→ "Fig. 106"). Confirm this information message by pressing the **OK** button to start the additional instructions for continuing the staining process.

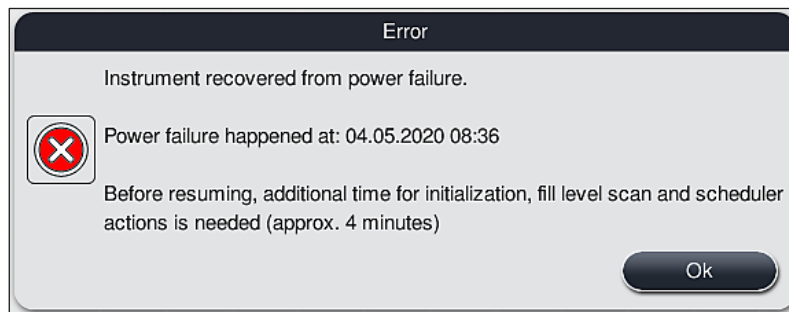

Fig. 106

1. After confirming this information message, the user is informed that the staining periods may have been exceeded, i.e. individual racks have already spent too much time in a reagent under certain circumstances or in a critical station, which can impede the staining quality. Confirm this information message (→ "Fig. 107") by pressing the **OK** button to resume.

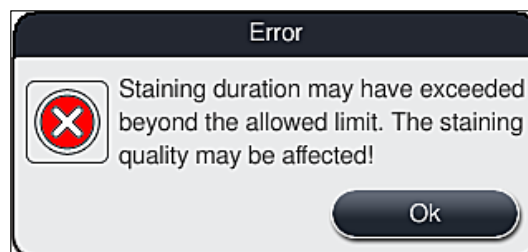

Fig. 107

2. Following this, this information message prompts the user to check (→ "Fig. 108") whether or not the instrument has placed one or two racks in a secure position between two reagent vessels (→ "Fig. 104").

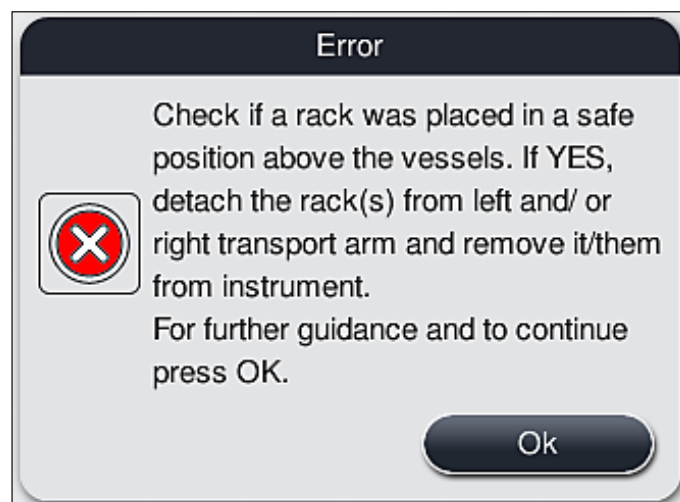

Fig. 108

3. After pressing the **OK** button (→ "Fig. 108"), another information message appears (→ "Fig. 109") that provides the user with instructions regarding the correct procedure for removing the respective racks.

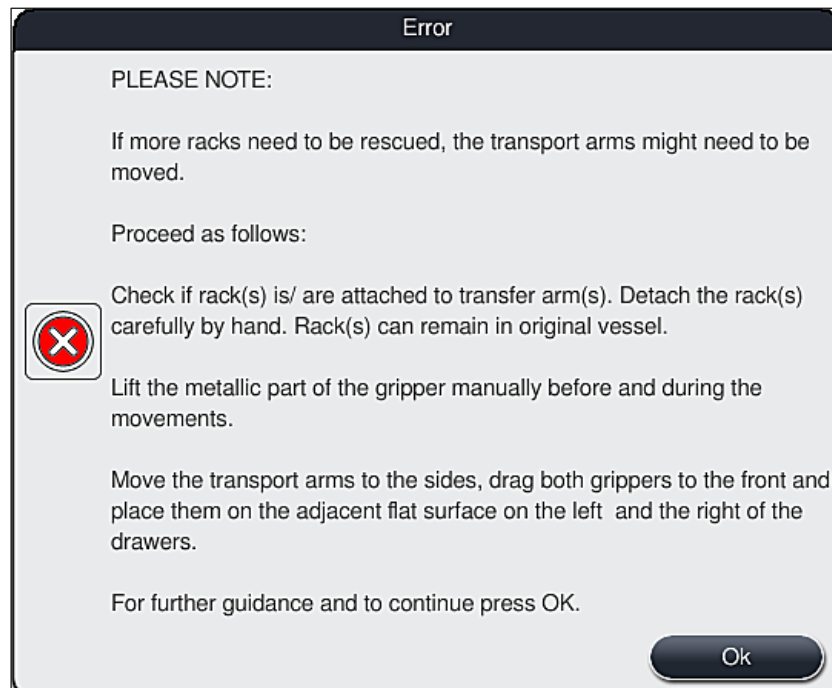

Fig. 109

4. Following this, the user has the option of selecting whether or not the staining process is to be resumed (→ P. 136 – 8.2.2 Resuming the staining process after a power failure) or canceled (→ P. 137 – 8.2.3 Canceling all staining processes after a power failure)(→ "Fig. 110").

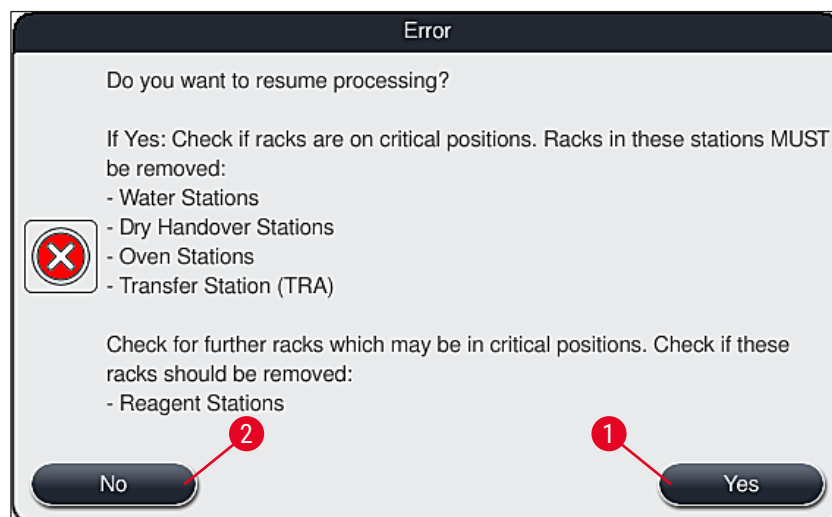

Fig. 110

8.2.2 Resuming the staining process after a power failure

1. To resume the staining process, press the **Yes** button (→ "Fig. 110-1").

**Note**

In the following menu, the racks in progress are displayed in the overview of the bathlayout (→ "Fig. 111").

2. Remove the critical racks from the instrument in accordance with the previous information message (→ "Fig. 110") and confirm the removal by pressing the corresponding station (→ "Fig. 111-1") on the screen.

**Note**

- It is only possible to remove the racks in progress at the time of the power failure using the method described here.
- The specimen of the removed racks are to be stored secured outside of the instrument, i.e. the staining process is to be completed manually.

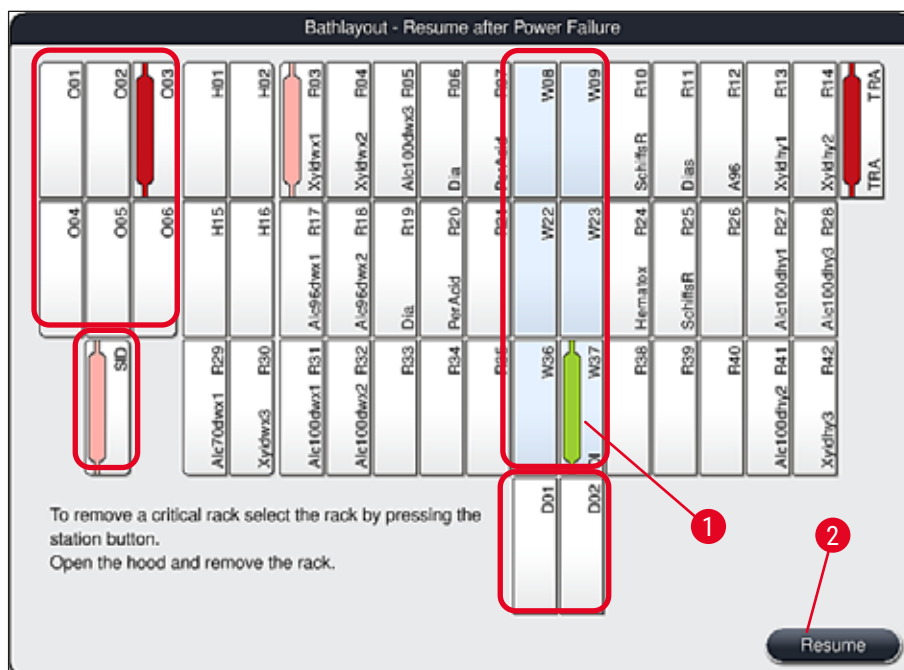

Fig. 111

3. If all critical racks have been removed, press the **Resume** button, observe the following information message and confirm by pressing the **OK** button.
4. Finally, the instrument carries out an automatic fill level scan and resumes the staining process for the racks remaining in the instrument.

**Warning**

- The remaining racks in the load drawer are not detected under certain circumstances. In this case, open the load drawer and close it again.
- A program must be assigned to white racks again.
- For white racks, the load drawer must also be opened and the specimen slide marking must be inspected for the identification of the correct programs to determine which program is to be reassigned.

8.2.3 Canceling all staining processes after a power failure

1. If the staining process for all racks is to be canceled, press the **No** (→ "Fig. 110-2") button and confirm the following warning message by pressing **OK** (→ "Fig. 112-1") to begin the removal of the racks.

**Note**

The cancellation of the staining process and the return to the previous selection menu (→ "Fig. 110") can be undone by pressing the **Cancel** button (→ "Fig. 112-2").

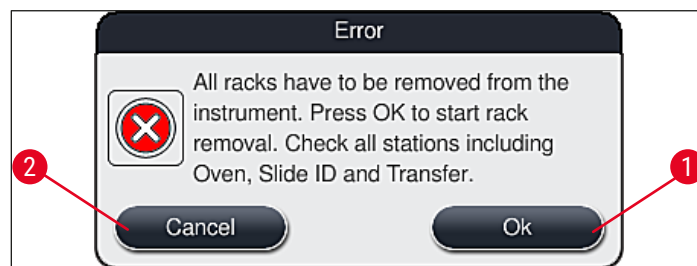
**Fig. 112**

2. Open the instrument cover and remove all racks.
3. Confirm the removal of the rack by touching the corresponding station (→ "Fig. 113-1") on the screen.

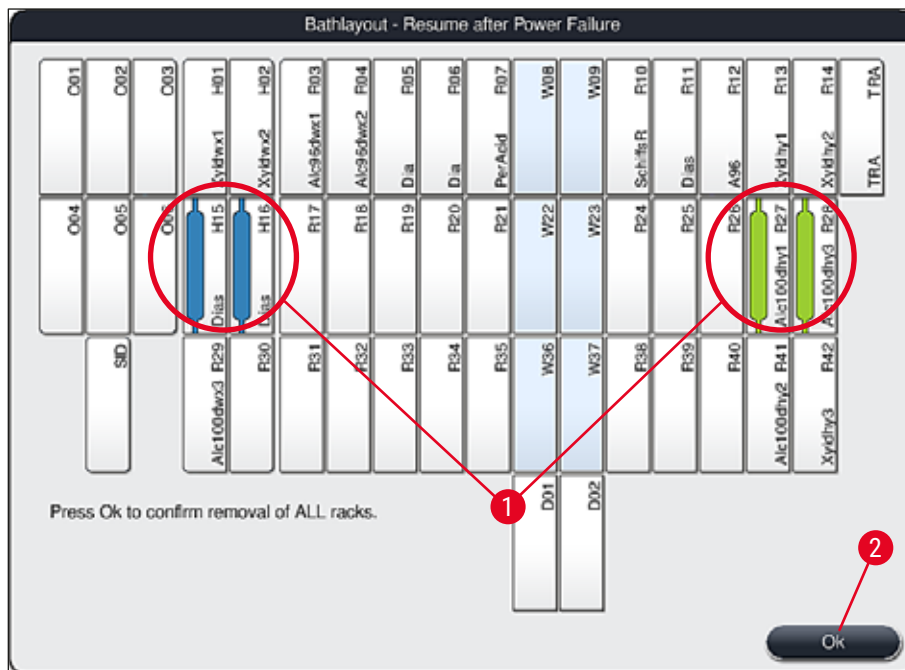

Fig. 113

- After removing all of the racks successfully, press the **OK** button (→ "Fig. 113-2") to leave the menu and to resume the initialization of the instrument.



Warning

- The remaining racks in the load drawer are not detected under certain circumstances. In this case, open the load drawer and close it again.
- A program must be assigned to white racks again.
- For white racks, the load drawer must also be opened and the specimen slide marking must be checked to identify the correct programs.

- ✓ After removing the critical racks from the instrument, the remaining racks are further processed and new racks can be inserted into the load drawer.

8.2.4 Detaching a rack from the gripper mechanism

- ① The racks are secured on the bottom of the gripper mechanism by the gripper mechanism using two hooks. In the event of a power failure, the rack must be released from the gripper mechanism for the removal from the instrument.



Warning

In case the transport arm(s) must be lifted and moved, note the symbol on the front (→ "Fig. 115-7") and do not touch or move the transport arm(s) at the sensor/antenna area (→ "Fig. 115-6"). For this purpose lift the metallic part of the gripper (→ "Fig. 115-1") manually and move the transport arm(s) carefully to the necessary position.

1. Grasp with one hand under the colored rack handle (→ "Fig. 115-2") and push it upwards slightly (→ "Fig. 115-3").
2. Slide the rack approx. 1 cm toward the inside of the specimen (→ "Fig. 115-4").
3. Grasp the gripper mechanism (→ "Fig. 115-1") with your free hand, slide it upwards (→ "Fig. 115-5") and firmly hold.
4. The rack can now be removed from the instrument and set aside.
5. Finally, pull the gripper mechanism forwards and carefully place it on the free surface next to the left load drawer (→ "Fig. 116-3") or next to the right unload drawer (→ "Fig. 116-6").

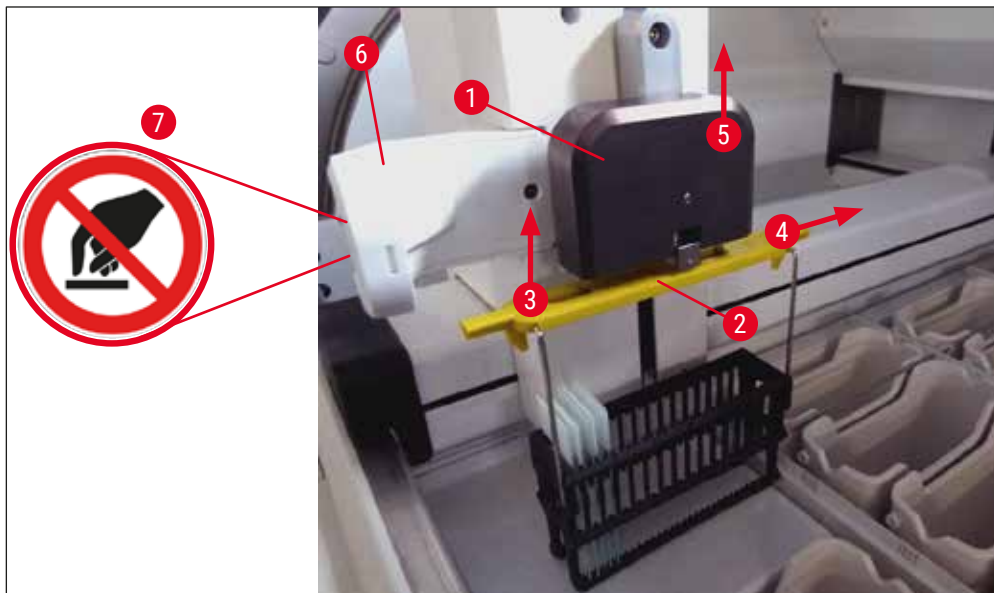

Fig. 115

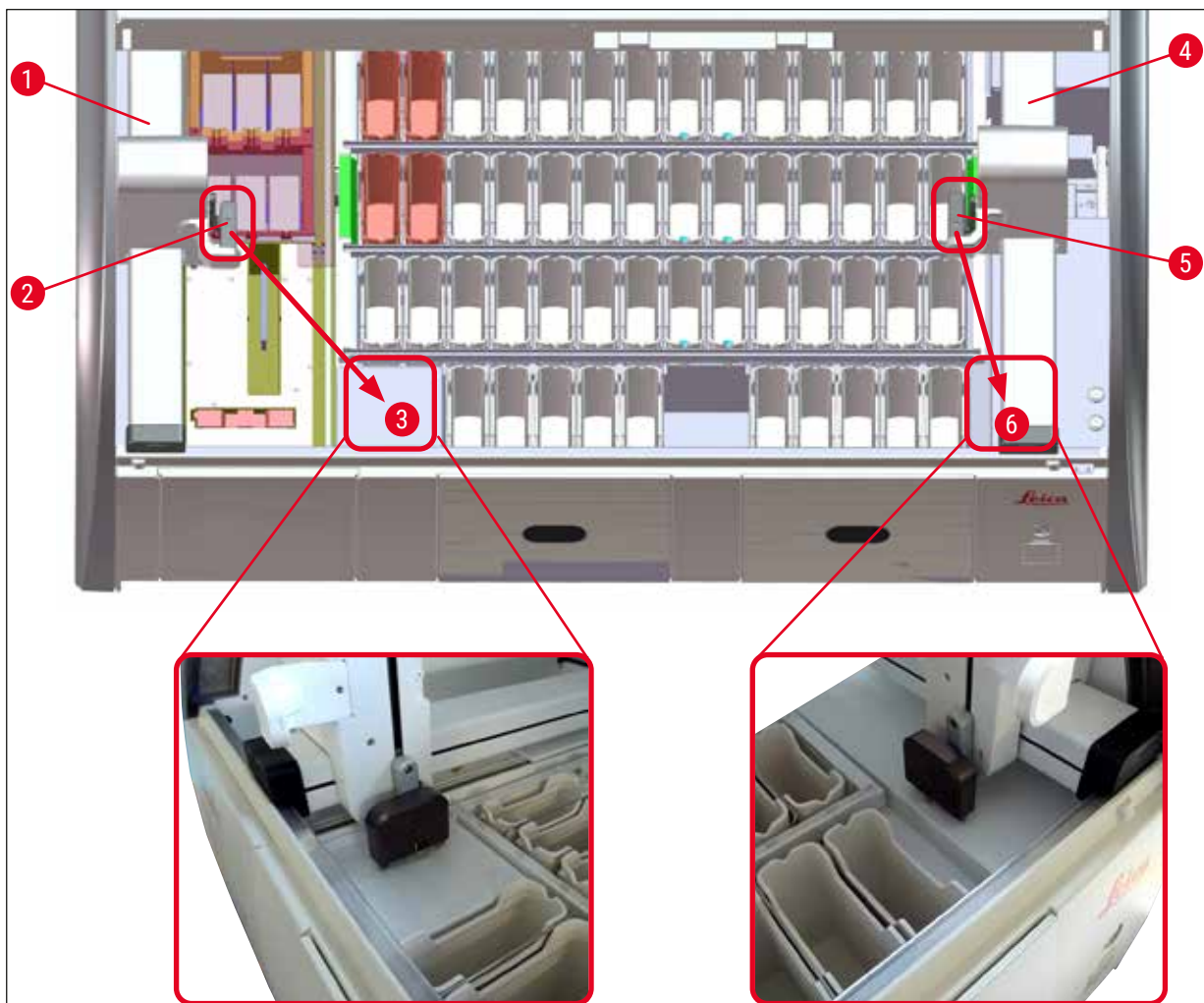

Fig. 116



Warning

After restarting the instrument, an error message appears which can be used to call up the bathlayout (→ "Fig. 40") for assistance in removing the specific rack. All racks in progress must be removed from the instrument by the user manually. Also check the specimen slide counter station (→ "Fig. 3-2") and the oven (→ "Fig. 3-10") on the rack and replace these if necessary:

The specimens must be stored outside of the instrument in a suitable reagent and the steps of the already started staining programs must be continued manually until the end of the program. The user shall be responsible for further processing of the samples.

- After the power supply is restored, the instrument can be restarted and loaded with new specimens.



Note

In the event of severe instrument malfunctions requiring removal of specimens from the instrument due to a cancellation of the staining process, the procedure in the outlined power failure scenario must be followed. Severe instrument malfunctions are indicated by a defined alarm sound (→ P. 47 – 5.7.4 Menu for alarm tones – Error and signal tones).

8.2.5 Removal of a rack from the transfer station

① If a malfunction occurs in workstation mode while the transfer device of the HistoCore SPECTRA ST transfers a rack to the HistoCore SPECTRA CV using the transfer station, the user must check where the rack is located.

1. Open the hood of the HistoCore SPECTRA ST.
2. Check whether the rack is still visible from the transfer station (→ "Fig. 117-1").

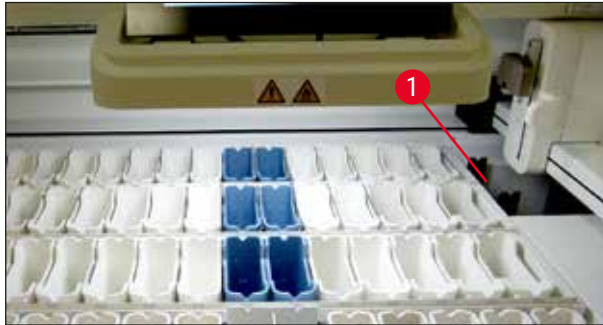

Fig. 117

3. If this is the case, push the sledge (→ "Fig. 118-1") for the transfer station back into the HistoCore SPECTRA ST manually (→ "Fig. 118-2") and remove the rack (→ "Fig. 118-3") from the holder (→ "Fig. 118-4").

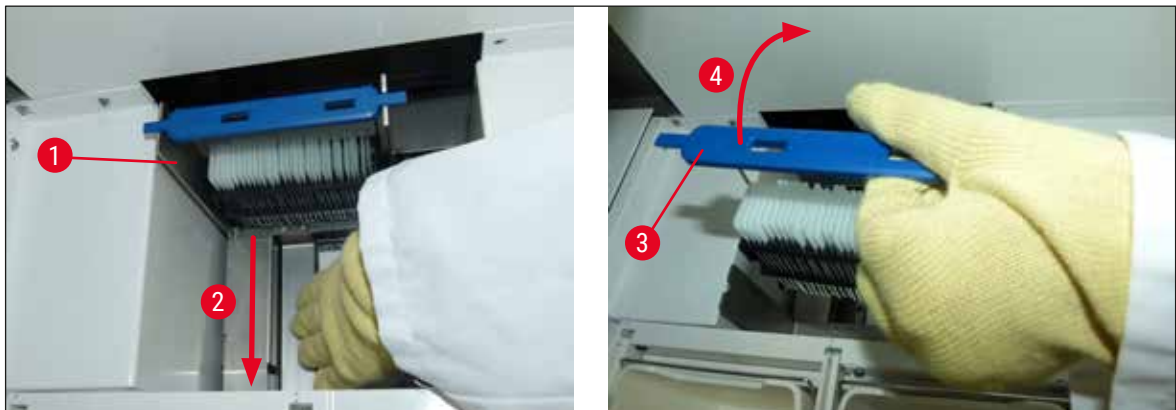

Fig. 118

4. Following this, remove the rack from the instrument and store it safely.
5. After the instrument fault has been corrected, insert the rack in the load drawer of the HistoCore SPECTRA CV to start the coverslipping process.

8.3 Replacing main fuses



Warning

The instrument should be shut down using the **power switch** and disconnected from the power supply in the case of a instrument failure. The main fuses can then be inspected.

- To do so, open the hood and unscrew the two fuse holders on the top of the right cover (→ "Fig. 119-1") with a flat-head screwdriver and check for damage.



Warning

A suitable flat-head screwdriver must be used to prevent damage to the fuse holder.



Warning

Beware of defective fuses! Potential risk of injury due to broken glass!



Fig. 119

- If the fuse is defective, remove it from the fuse holder and replace it with a new fuse (→ P. 20 – 3.1 [Standard delivery](#)).
- Installation occurs in the reverse sequence of operations.

8.4 Water drain system blocked

A water drain system blockage can be caused by a blocked drain sieve (→ "Fig. 98-1") or drain hose (→ "Fig. 7-1"). Such blockage could lead to a rising water level in the drain pan. As a result, a critical water level can be reached in the instrument. The user receives an error message on the screen (→ "Fig. 120") and an alarm sounds. The error message provides the user guidance to resolve the blockage by a sequence of repetitive pictures (→ "Fig. 122").



Fig. 120



Warning

Losses in quality and delays in the staining process can occur in the event of a critical rising water level in the instrument resulting from a water drainage system blockage. Ongoing staining programs are temporarily stopped. The blockage has to be remedied immediately by the user as described below.

Removing a water drain system blockage

1. Open the hood.
2. Check the water outlet system (→ P. 120 – 7.12 Water drainage).



Note

- If racks are located in the rinsing water vessels (→ "Fig. 122-1"), they must be removed (→ "Fig. 122-2") and stored temporarily in water outside of the instrument (→ "Fig. 122-3").
- Write down the position of the removed rack to ensure that the staining process can be resumed again after removing the blockage.
- The neighboring reagent vessels are to be covered for protection and can remain in the instrument for the time being.
- If the water level in the drain pan falls below the critical level during the solving process, the message (→ "Fig. 120") disappears and another message on the display informs the user that the staining process can be continued.

3. Carefully remove the rinsing water vessels (→ "Fig. 122-4") and, if necessary, the neighboring reagent vessels over the drainage sieve (→ P. 120 – 7.12 Water drainage).



Warning

Be careful when removing the rinsing water vessels. Lift each individual rinsing water vessel and allow the water inside of it to run into the drain pan. In order to remove the vessels from the instrument without having water drip into the reagent vessel, it is necessary to drain them completely.

4. Check the drainage sieve and the curved drainage in the inside of the instrument (→ "Fig. 122-5") for clogs and clean them as described in (→ P. 120 – 7.12 Water drainage) and (→ P. 121 – 7.13 Water drain hose), if necessary.
 5. Put back the previously removed rinsing water vessels (→ "Fig. 122-6") and reagent vessels. Place racks (→ "Fig. 122-7") back into their original positions (→ "Fig. 122-8").
 6. Press **Ok** (→ "Fig. 120-1") to continue.
- ✓ If the blocked water drains, another message on the display (→ "Fig. 121") informs the user that staining programs can be continued. Press **Ok** (→ "Fig. 121") to continue.

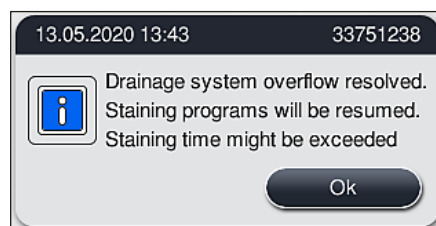

Fig. 121

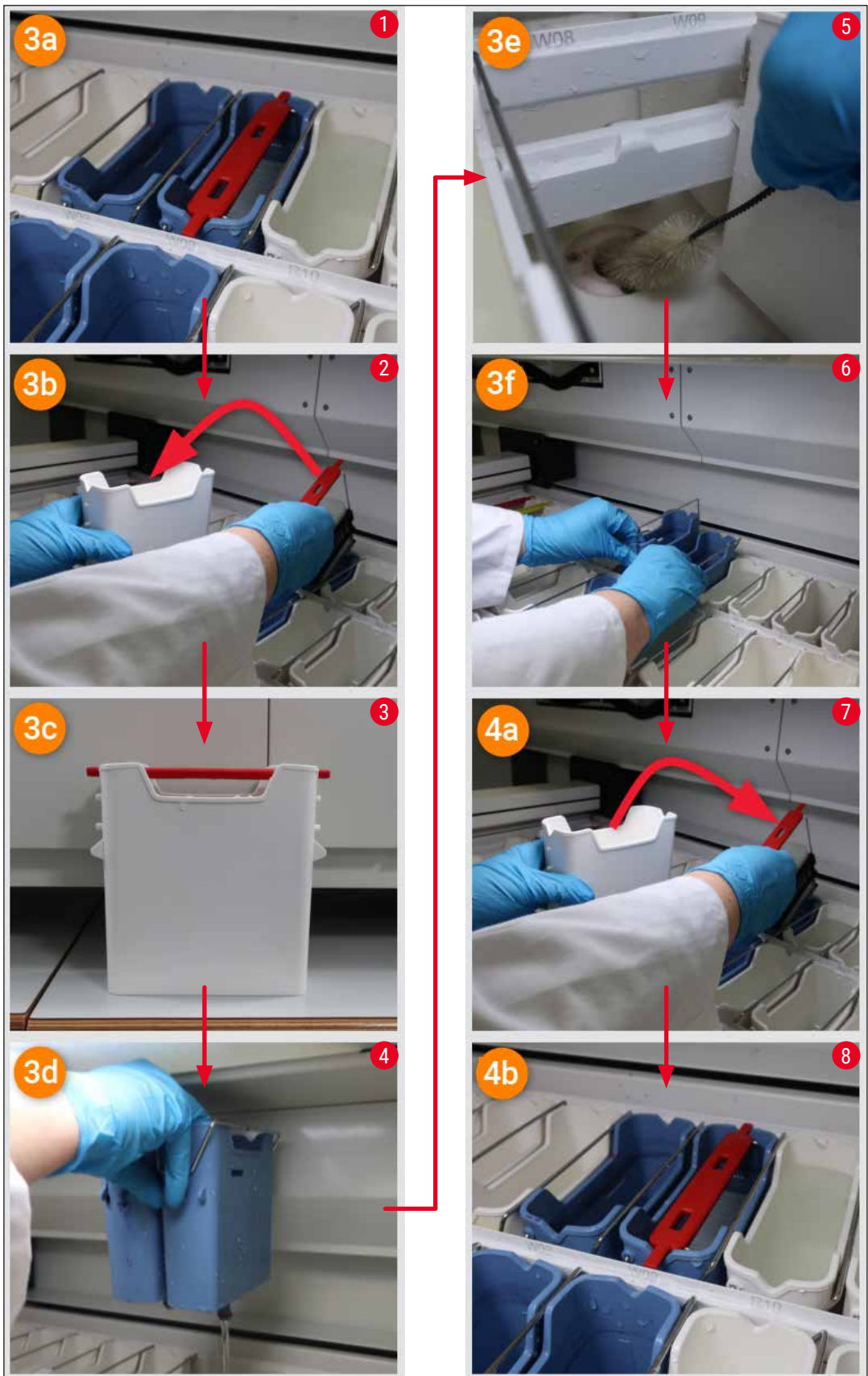

Fig. 122

Water drain system blockage not resolved, blockage still persists

If the message (→ "Fig. 120-1") is confirmed with **OK**, but the blockage still persists, the user is informed by a new message (→ "Fig. 123") that a further period of 5 minutes is available in which the persisting high water level in the tub is continuously checked by the system. In this interval, the user can carry out further cleaning attempts.

**Note**

If necessary, the user can abort all racks which need a water step. To do so, press **Cancel** (→ "Fig. 123-1") and confirm the following message by pressing **Yes** (→ "Fig. 123-2") to start the controlled abortion process. Press **No** (→ "Fig. 123-3") to continue the waiting period.

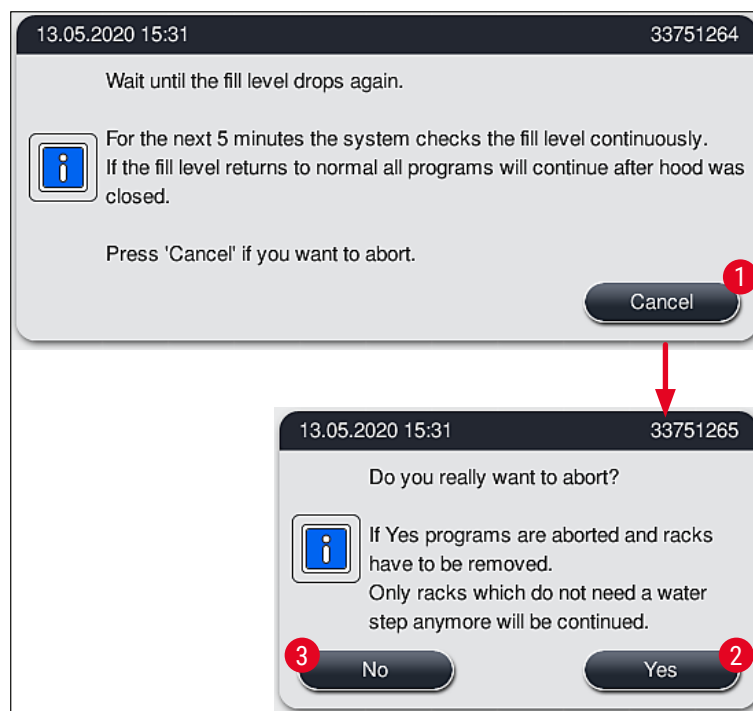

Fig. 123

From this point on there are 3 different options:

1. If the further cleaning attempts are successful and the blockage could be removed, the water level falls below the critical level. A message on the display (→ "Fig. 121") informs the user that staining programs can be continued. Press **Ok** (→ "Fig. 121") to continue. The startability of the programs is displayed and the programs in the process continue automatically.
2. After 5 minutes and after further cleaning attempts were carried out but the blockage still persists, a message (→ "Fig. 124") on the display shows the user that the water level is still too high. By pressing **No** (→ "Fig. 124-1"), the user can extend the waiting time by another 5 minutes to carry out further cleaning attempts. If the further cleaning attempts in this second interval are successful, the situation is solved as described under 1. If additional time is required for the cleaning measures, press again **No** (→ "Fig. 124-1"). The interval can be repeated multiple times. If the blockage could not be released despite all cleaning attempts, press **Yes** (→ "Fig. 124-2") to start a controlled abortion process, see the following sections 3 and 4.

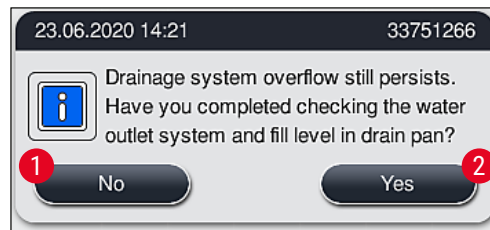

Fig. 124

3. If the blockage can not be removed despite the cleaning measures, the water stations are deactivated due to the persisting critical water level. The water stations are shown as defective on the display. To abort one or more programs, press either (→ "Fig. 123-2") or (→ "Fig. 124-2") to start the controlled abortion process. Programs that do not require a water step are continued until the end of the staining process. Any remaining racks which still require at least one water step must be canceled and removed from the instrument. Confirm the following message (→ "Fig. 125") by pressing **Ok**.

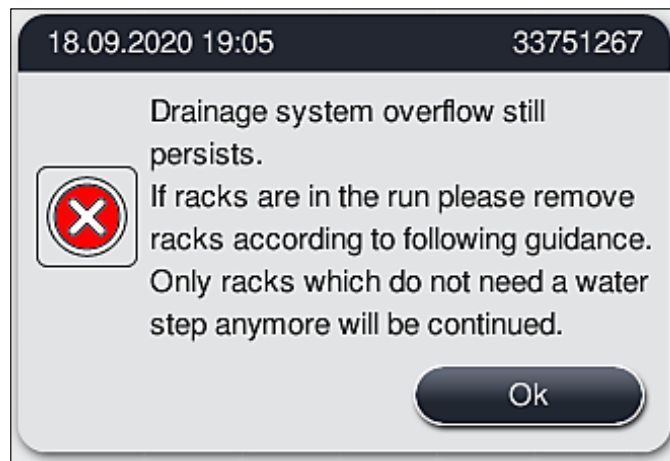

Fig. 125

4. For each rack to be removed, a corresponding message is shown on the display (→ "Fig. 126"). Open the hood and remove the rack out of the station shown in the message. Confirm the removal with **Ok**. Continue until all affected racks have been removed.



Fig. 126

- ✓ After the last rack has been removed, a message informs the user, which programs are no longer startable because of the deactivated water stations, press **Ok** (→ "Fig. 127-1") to continue. The water stations are marked as defective (→ "Fig. 127-2") on the display.

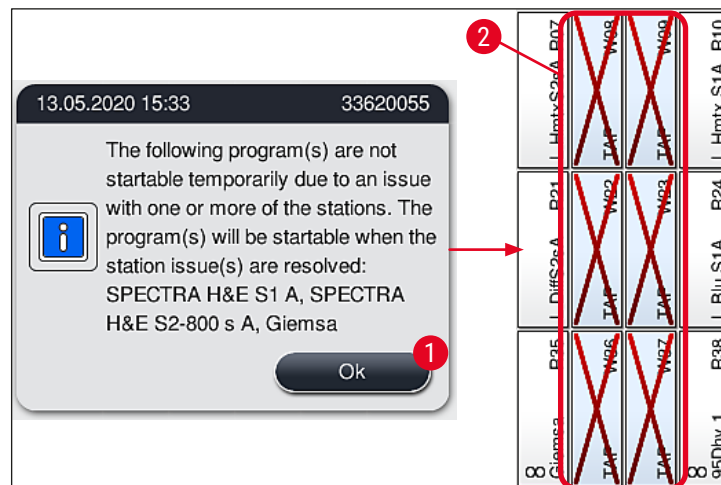

Fig. 127

**Warning**

In the event of persistent or frequently recurring blockages, the responsible Leica Service Organization must be informed.

**Note**

Programs which did not include a water step are still startable. Notifying the responsible Leica Service Organization is highly recommended.

8.5 Errors when attaching, detaching or transporting racks

**Warning**

In case the gripper and/or the transport arm are not able to lift, place or transport a rack, the user is notified about the failure via a warning message on the screen, i.e. (→ "Fig. 128"). **NEVER** open the hood in this situation to avoid abortion of all racks in process! Otherwise the aborted racks must be removed from the instrument immediately and staining must be finished manually!

In case that the transport arm(s) must be lifted and moved, do not touch or move the transport arm(s) at the sensor/antenna area (→ "Fig. 115-6"). For this purpose lift the metallic part of the gripper (→ "Fig. 115-1") manually and move the transport arm(s) carefully to the necessary position.

1. The message provides information about the location of the failure. Check this location through the closed hood for blockages or obstacles.
2. If no blockages or obstacles are obvious, press **Ok** (→ "Fig. 128-1") to again lift, place or transport the rack.

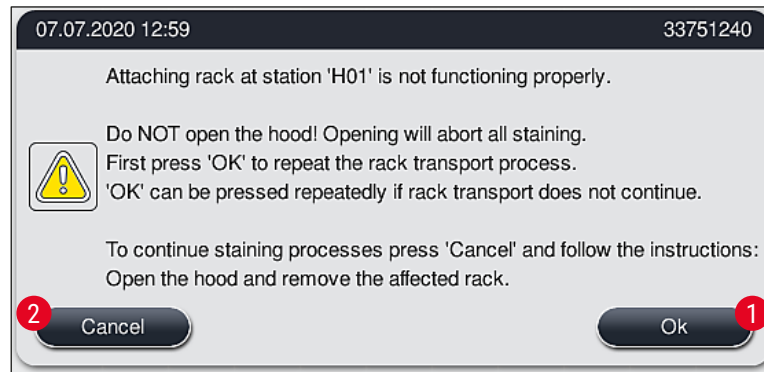

Fig. 128

**Note**

The **Ok** button (→ "Fig. 128-1") can be pressed repeatedly if the rack transport does not continue.

3. In case a blockage/obstacle will be recognized or after pressing **Ok** repeatedly without success, press **Cancel** (→ "Fig. 128-2") to abort the specific rack safely and to continue the staining process for the remaining racks.
4. **NOW** open the hood and remove the rack from the instrument.
5. Confirm by pressing **Ok** (→ "Fig. 129").

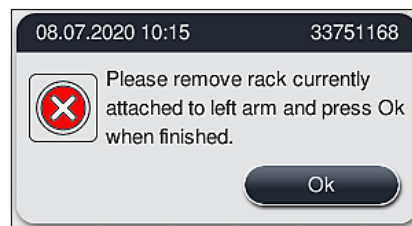

Fig. 129

**Note**

- Please note that the removed rack can not be continued! All other racks in process will be finished.
- Store the removed rack outside of the instrument in a suitable reagent. The staining of the slides of this rack needs to be finished manually.

9. Instrument Components and Specifications

9.1 Optional instrument components

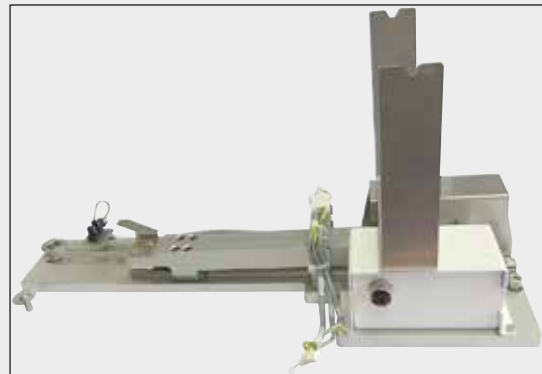

Fig. 131

HistoCore workstation kit

For use in the HistoCore SPECTRA ST, for transferring samples to a connected robotic coverslipper HistoCore SPECTRA CV. The two instruments form a workstation after the installation of the kit.

The kit contains the transfer module and all parts required for the integration in the HistoCore SPECTRA ST.

Order No.:

14 0512 54355

9.2 Optional accessories

Designation	Order No.
Exhaust hose, 2 m	14 0512 54365
Active carbon filter set (2 pcs.)	14 0512 53772
Replacement filter for oven air filter (3 pieces)	14 0512 54943
Outlet hose, 2 m	14 0512 55279
Supply hose	14 0474 32325
Reagent vessel, assembly, including reagent vessel cover	14 0512 47086
Vessel cover kit, consisting of 3 covers	14 0512 57846
Water connection kit, consisting of:	14 0512 49324
2 pc. Water inlet hose, 10 mm, 2.5 m	14 0474 32325
1 pc. Extension hose, 1.5 m	14 0512 49334
1 pc. Y-junction G3/4	14 3000 00351
1 pc. Double nipple G3/4 G1/2	14 3000 00359
1 pc. Filter housing	14 0512 49331
1 pc. Filter cartridge	14 0512 49332
1 pc. Pipe coupling G3/4	14 3000 00360
1 pc. Blind cap G3/4	14 3000 00434
1 pc. Seal washer	14 0512 54772
1 pc. Single-head wrench SW30 DIN894	14 0330 54755
HistoCore workstation kit	14 0512 54355

Designation	Order No.
Insert for special stainings	14 0512 49261
Water Filter Holder assembly	14 0512 59363
Rinsing water vessel, blue, assembly	14 0512 47087
Molykote 111 grease, 100 g	14 0336 35460
Set of label covers for the load and unload drawers (10 blank, 5 each of "H2O"=water, "A"=alcohol and "S"=solvent, e.g. xylene)	14 0512 55161
O-rings 7x2, for rinsing water vessel connecting piece (12 pcs. per package)	14 0253 54716
Rack for 30 spec. sl.* (3 pcs. per package)	14 0512 52473
Rack for 5 spec. sl.* (3 pcs. per package)	14 0512 52475
Handle for rack for 30 spec. sl.* (yellow, 3 pcs. per package)	14 0512 52476
Handle for rack for 30 spec. sl.* (lightblue, 3 pcs. per package)	14 0512 52477
Handle for rack for 30 spec. sl.* (darkblue, 3 pcs. per package)	14 0512 52478
Handle for rack for 30 spec. sl.* (pink, 3 pcs. per package)	14 0512 52479
Handle for rack for 30 spec. sl.* (red, 3 pcs. per package)	14 0512 52480
Handle for rack for 30 spec. sl.* (light green, 3 pcs. per package)	14 0512 52481
Handle for rack for 30 spec. sl.* (black, 3 pcs. per package)	14 0512 52482
Handle for rack for 30 spec. sl.* (gray, 3 pcs. per package)	14 0512 52483
Handle for rack for 30 spec. sl.* (white, 3 pcs. per package)	14 0512 52484
Handle for rack for 5 spec. sl.* (yellow, 3 pcs. per package)	14 0512 52494
Handle for rack for 5 spec. sl.* (lightblue, 3 pcs. per package)	14 0512 52495
Handle for rack for 5 spec. sl.* (darkblue, 3 pcs. per package)	14 0512 52496
Handle for rack for 5 spec. sl.* (pink, 3 pcs. per package)	14 0512 52497
Handle for rack for 5 spec. sl.* (red, 3 pcs. per package)	14 0512 52498
Handle for rack for 5 spec. sl.* (light green, 3 pcs. per package)	14 0512 52499
Handle for rack for 5 spec. sl.* (black, 3 pcs. per package)	14 0512 52500
Handle for rack for 5 spec. sl.* (gray, 3 pcs. per package)	14 0512 52501
Handle for rack for 5 spec. sl.* (white, 3 pcs. per package)	14 0512 52502

(* Specimen slide)



Note

- Information about the available Leica reagent kits and validated Leica programs can be requested from the responsible Leica sales organization.
- Furthermore, instructions for use is provided with each Leica reagents kit, in which a supply source is specified for the import of validated Leica programs.

Rack handles for racks from other manufacturers



Note

The use of this rack adapter has been verified once in the HistoCore SPECTRA ST together with the Sakura slide holder (Sakura 20-slide basket, product code 4768) available in October 2017.

Since changes may be made by the manufacturer of the slide holder to the type verified by Leica, we recommend that the customer performs a test run, prior to clinical use of the adapter.

Adapter handle for Sakura 20 rack (yellow, 3 pcs. for each package)	14 0512 55661
Adapter handle for Sakura 20 rack (lightblue, 3 pcs. for each package)	14 0512 55662
Adapter handle for Sakura 20 rack (darkblue, 3 pcs. for each package)	14 0512 55663
Adapter handle for Sakura 20 rack (pink, 3 pcs. for each package)	14 0512 55664
Adapter handle for Sakura 20 rack (red, 3 pcs. for each package)	14 0512 55665
Adapter handle for Sakura 20 rack (light green, 3 pcs. for each package)	14 0512 55666
Adapter handle for Sakura 20 rack (black, 3 pcs. for each package)	14 0512 55667
Adapter handle for Sakura 20 rack (gray, 3 pcs. for each package)	14 0512 55668
Adapter handle for Sakura 20 rack (white, 3 pcs. for each package)	14 0512 55669

For special applications (extra-large slides)

The adapter handles for the Sakura 20-slide racks can be used for the special application to stain extra-large slides (special size 76 mm x 52 mm).

This special application requires the combination of the following optional Leica accessories:



Warning

Extra-large slides of special size 76 x 52 mm must never be inserted into racks for 30 slides for staining in the HistoCore SPECTRA ST.

The use of extra-large slides (size 76 x 52 mm) is only possible using a 20-slide rack together with optional Leica accessories! Because extra-large slides must be inserted lengthwise into a slide rack (→ "Fig. 132-4"), using a 30-slide rack would result in the slides being damaged or destroyed in the slide counter!

The instrument itself is not able to recognize extra-large slides!

- Adapter handle for Sakura 20 rack (→ "Fig. 132-1"), available in different colors (→ P. 152 – Rack handles for racks from other manufacturers).
- Slide rack 20, type Sakura (→ "Fig. 132-2"), plastic, order number 14 0474 33463
- Leica Adapter for large slides (→ "Fig. 132-3"), order number 14 0456 27069, pack of two Adapter for individual extra-large slides, for inserting up to 5 slides (→ "Fig. 132-4") with the following size:
Height: approx. 76 mm width: between 26 mm and 52 mm, thickness of the slide: optimally 1 mm, max. 1.9 mm

**Note**

Due to the special lengthwise orientation of the extra-large slides in the Leica Sakura type rack for 20 slides, there may be minimal deviations in the transfer to the RMS data during slide counting. These consumption data, **slides since last exchange** (→ "Fig. 76"), are displayed minimally lower than is actually the case. The staining result should not be affected by these minimal deviations. For special stains the user must consider this behavior.

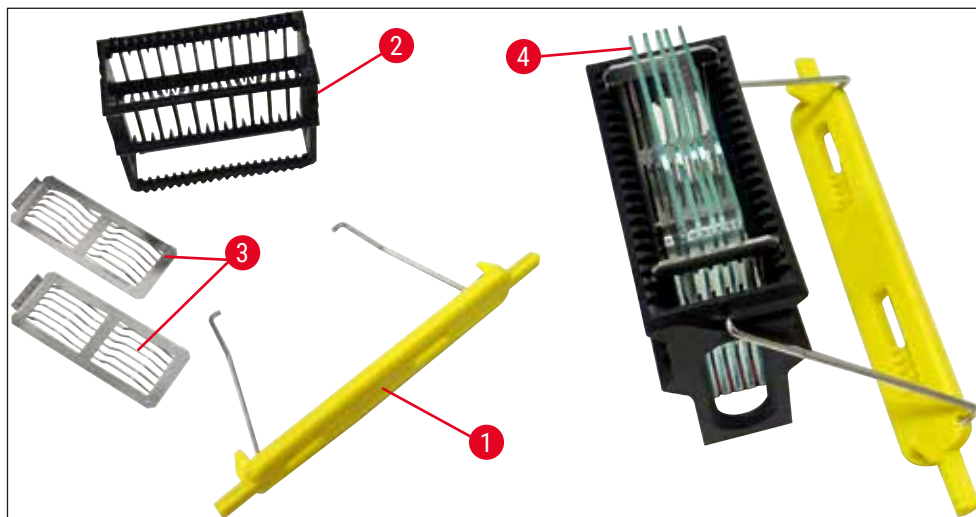

Fig. 132



Fig. 133

Outlet hose

Length: 2 m

Order No.:

14 0512 55279



Fig. 134

Supply hose for rinsing water

Length: 2.50 m assembly with 3/4" connection for water tap, incl. replacement seal

Order No.: 14 0474 32325



Fig. 135

Water connection kit

Order No.: 14 0512 49324

Consisting of:

- 2x Water inlet hose, 10 mm, 2.5 m 14 0474 32325
- Extension hose, 1.5 m 14 0512 49334
- Y-junction G3/4 14 3000 00351
- 2x Double nipple G3/4 G1/2 14 3000 00359
- Filter housing 14 0512 49331
- Filter cartridge 14 0512 49332
- Pipe coupling G3/4 14 3000 00360
- Blind cap G3/4 14 3000 00434
- Seal washer 14 0512 54772
- Single-head wrench SW30 DIN894 14 0330 54755



Fig. 136

Exhaust hose

Length: 2 m

Order No.:**14 0512 54365**

Fig. 137

Active carbon filter

1 set, consisting of 2 pcs.

Order No.:**14 0512 53772**

Fig. 138

Reagent vessel

Assembly, incl. reagent vessel cover

Order No.:**14 0512 47086**

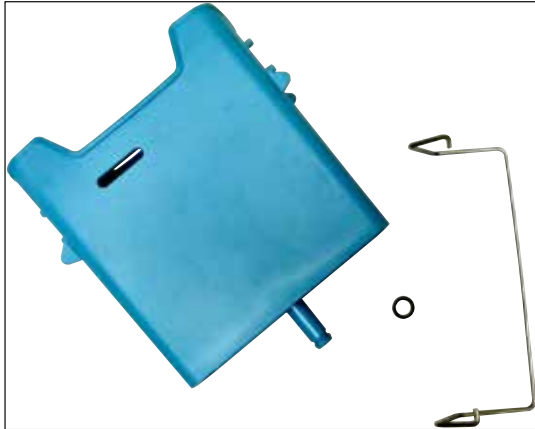

Fig. 139

**Rinsing water vessel
assembly**

Order No.:

14 0512 47087



Fig. 140

Insert for special stainings

(only for racks designed for up to 5 specimen slides)

Order No.:

14 0512 49261



Fig. 141

Racks

30 specimen slides, (3 pcs. per package)

Order No.:

14 0512 52473

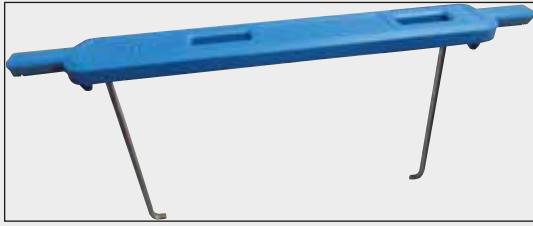

Fig. 142

Handle for rack

30 specimen slides, (3 pcs. per package)

Color

- yellow
- lightblue
- darkblue
- pink
- red
- light green
- black
- gray
- white

Order No.:

- 14 0512 52476
- 14 0512 52477
- 14 0512 52478
- 14 0512 52479
- 14 0512 52480
- 14 0512 52481
- 14 0512 52482
- 14 0512 52483
- 14 0512 52484



Fig. 143

Racks

5 specimen slides, (3 pcs. per package)

Order No.:

14 0512 52475



Fig. 144

Handle for rack

5 specimen slides, (3 pcs. per package)

Color

- yellow
- lightblue
- darkblue
- pink
- red
- light green
- black
- gray
- white

Order No.:

- 14 0512 52494
- 14 0512 52495
- 14 0512 52496
- 14 0512 52497
- 14 0512 52498
- 14 0512 52499
- 14 0512 52500
- 14 0512 52501
- 14 0512 52502



Fig. 145

Leica adapter for large slides

2 pcs. per package.

To be used to stain 5 extra-large slides with a size of 76 x 52 mm, together with slide rack 20, type Sakura and Adapter handle for Sakura 20 rack (→ P. 152 – For special applications (extra-large slides)).

Order No.: 14 0456 27069



Fig. 146

Vessel cover kit

Using one cover, an entire row of reagent vessels (14 pieces) in the vessel field (→ "Fig. 65") can be covered.

Order No.: 14 0512 57846

Consisting of:

• 3 vessel covers 14 0512 57847

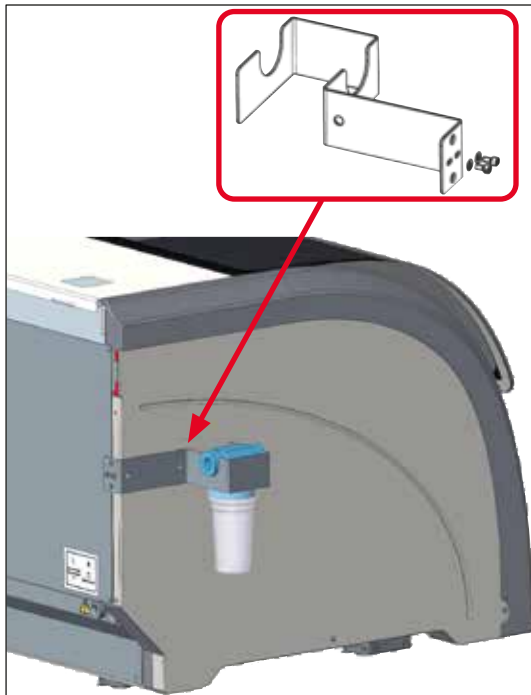

Fig. 147

Water Filter Holder Assembly

To be fixed on the left side of the HistoCore SPECTRA ST

The Water Filter Holder can be used to secure the water filter and to grant the user an improved accessibility and visibility.

Order No.: 14 0512 59363

Consisting of:

- 1 Water Filter Holder 14 0512 59364
- 2 Cap screws 14 2101 03234
- 2 Washers 14 2171 02114

Please note: The installation of the Water Filter Holder has to be carried out by personnel authorized by Leica only!

10. Warranty and Service

Warranty

Leica Biosystems Nussloch GmbH guarantees that the contractual product delivered has been subjected to a comprehensive quality control procedure based on the Leica in-house testing standards, and that the product is faultless and reflects all technical specifications and/or agreed characteristics.

The scope of the warranty is based on the content of the concluded agreement. The warranty terms of your Leica sales organization or the organization from which you have purchased the contractual product shall apply exclusively.

Yearly Preventive Maintenance

Leica recommends to conduct a yearly preventive maintenance. This has to be performed by a qualified Leica Service Representative.

Service information

If you are in need of technical customer support or spare parts, please contact your Leica representative or the Leica dealer where you purchased the instrument.

Please provide the following information on the instrument:

- Model name and serial number of the instrument.
- Location of the instrument and name of a contact person.
- Reason for the service call.
- The delivery date of the instrument.

11. Decommissioning and Disposal



Warning

The instrument or parts of the instrument must be disposed of according to existing applicable, local regulations. All objects contaminated with spilled reagents must be disinfected immediately with a suitable disinfectant to prevent spreading to other areas of the lab or to lab personnel.

Please refer to the (→ P. 114 – 7. [Cleaning and Maintenance](#)) Chapter as well as the Decontamination Confirmation (→ P. 162 – 12. [Decontamination Confirmation](#)) Chapter at the end of these Instructions for Use in order to find information about cleaning the HistoCore SPECTRA ST stainer.

The instrument can be contaminated when using biohazardous specimens. Thorough disinfecting is required before re-commissioning or disposal (e.g. multiple cleaning steps, disinfection or sterilization). Dispose of the instrument in compliance with the applicable laboratory specifications.

Contact your Leica representative for more information.



Instrument components such as the computer, monitor, etc. that are labeled with the crossed-out dust bin are affected by the European Directive 2002/96/EC for Waste Electrical and Electronic Equipment (WEEE) of the European Parliament and the Council of January 27, 2003.

These objects must be disposed of via the collection points in accordance with the local regulations. More information on disposal of the instrument can be obtained from your local disposal company or your local Leica support staff.

12. Decontamination Confirmation

Every product that is returned to Leica Biosystems or that requires on-site maintenance must be properly cleaned and decontaminated. You can find the dedicated template of the decontamination confirmation on our website www.LeicaBiosystems.com within the product menu. This template has to be used for gathering all required data.

When returning a product, a copy of the filled and signed confirmation has to be enclosed or passed on to the service technician. The responsibility for products that are sent back without this confirmation or with an incomplete confirmation lies with the sender. Returned goods that are considered to be a potential source of danger by the company will be sent back at the expense and risk of the sender.

A1. Appendix 1 - Compatible reagents



Warning

- Using non-listed reagents (e.g. acetone or solutions containing phenol) or reagents and acids in higher concentration than described can cause specimens to be destroyed, users to be injured or the instrument to be damaged. Use the instrument in this way at your own risk. Leica Biosystems or affiliated sales and service organizations shall not assume any warranty claims or liability.
- Flammable reagents and solvents must not be heated for fire and explosion protection reasons. Keep away all ignition sources when handling flammable solvents and reagents.



Note

All Leica reagents for preinstalled Leica programs have been tested with the instrument for staining quality and compatibility of materials.

Staining method or reagent group	Reagent name	Notes
H&E kit	Leica Infinity	ST Hemalast
		ST Hematoxylin
		ST Differentiator
		ST Bluing
		ST Eosin
	Leica SelecTech	Hematoxylin 560
		Hematoxylin 560MX
		Define MX-aq
		Blue Buffer-8
		Y515 Alcoholic Eosin
		Y515LT Alcoholic Eosin
		515 Eosin Trichrome
		Eosin Phloxine
		Other H&E reagents
Gill III Hematoxylin		
Harris Hematoxylin		
Mayer's Hemalaun		
Leica	Alcoholic Eosin	
	Aqueous Eosin (1 %)	
Leica	Scott's Tap Water Solution	
Leica	Acid Alcohol 0.5 %	
Leica	Acid Alcohol 1.0 %	
User-defined	Hydrochloric Acid 2 %	

A1 Appendix 1 - Compatible reagents

Staining method or reagent group	Reagent name	Notes	
PAS	Leica	Periodic Acid 0.5 %	
	User-defined	Periodic Acid (up to 10 %)	
	Leica	Schiff's Reagent	
Diastase-PAS	Leica	Diastase solution (37 °C)	
Alcian Blue-PAS	Leica	Alcian Blue-Solution	
Alcian Blue	Leica		
Alcian Blue and other Staining Methods	Leica	Nuclear fast Red	
Gomori Trichrome Blue and Green Collagen Staining	Leica	Weigert Hematoxylin (A+B Solution) Gomori Trichrome Blue Stain 1 % Acetic Acid Light green	
Perl's Iron Staining	Leica	Potassium ferrocyanide solution Hydrochloride Acid Solution	<ul style="list-style-type: none"> • Must not come into contact with metal ions • Only for use with coated 5 series rack handles
Giemsa	Leica	Methanol Solution A Stain 1 Solution B Stain 2 Solution C Buffer Solution D	
Congo Red Amyloid Stain	Leica	Congo Red Solution	
	Leica	1 % Potassium Hydroxide Solution	
	User-defined	Saturated Lithium Carbonate Solution	
Alcian Yellow for Helicobacter Pylori	Leica	Alcian Yellow-Solution (0.25 % Alcian Yellow) 5 % Periodic Acid 5 % Sodium Metabisulfite 6.8 pH Sorensen Buffer Toluidin Blue Solution	
Elastic Stain/ Verhoeff's van Gieson	Leica	5 % Alcoholic Hematoxylin 10 % Ferric Chloride Lugol's Iodin Solution 2 % Ferric Chloride Verhoeff's Staining Solution Van Gieson's Stain	

Staining method or reagent group	Reagent name	Notes
Gomori Methenamine Silver Stain	Leica Modified Chromic Acid (up to 5%) Methenamine Borax 0.5 % Silver Nitrate	<ul style="list-style-type: none"> • Must not come into contact with metal ions • Only for use with coated 5 series rack handles
	1 % Sodium Bisulfate 1 % Gold Chloride 2 % Sodium Thiosulfate Light green	
Papanicolaou (PAP)	Leica EA-50	
	Leica Orange G-6	
	Leica EA-65 (Secondary Counter Stain)	
Schmorl's Reduction	Schmorl's Solution	<ul style="list-style-type: none"> • Only for use with coated 5 series rack handles
(Müller) Colloidal Iron	Colloidal Iron Solution Ferrocyanide-Hydrochloric Acid Solution	<ul style="list-style-type: none"> • Only for use with coated 5 series rack handles
Other reagents	User-defined Anilin Blue	
	User-defined Methylene Blue	
	User-defined Fast Green	
	User-defined Carmin	
	User-defined Southgate or Mayer's Micicarmine	
	User-defined Neutral Red	
	User-defined Safranin	

A1 Appendix 1 - Compatible reagents

Staining method or reagent group	Reagent name	Notes	
Solvent	Leica/user-defined	Xylene, Toluene	
	Leica	Leica Ultra ST	Xylene Substitute based on Alipahitic Hydrocarbons
	Leica	Leica Clearene	Limonene based Xylene Substitute
	Merck	Merck Neo-Clear	Xylene Substitute based on Alipahitic Hydrocarbons
	Carl Roth	Roti®-Histol	Limonene based Xylene Substitute
	Richard-Allen Scientific/Thermo Scientific	Clear-Rite 3	Xylene Substitute based on Alipahitic Hydrocarbons
	Richard-Allen Scientific/Thermo Scientific	Citrus Clearing Solvent	Limonene based Xylene Substitute
Alcohol	Leica/user-defined	2-Propanol (Isopropanol)	
	Leica/user-defined	Ethanol Methanol	
	Richard-Allen Scientific/Thermo Scientific	Dehydrant	Ethyl Alcohol, Methyl Alcohol
	Richard-Allen Scientific/Thermo Scientific	Flex	Isopropyl, Alcohol, Methyl Alcohol
Usual Acids (Max. Concentration)	User-defined	Acetic Acid (up to 15 %) Hydrochloric Acid (up to 5 %) Piric Acid (up to 3 %)	

www.LeicaBiosystems.com



Leica Biosystems Nussloch GmbH
Heidelberger Strasse 17 - 19
69226 Nussloch
Germany

Tel.: +49 - (0) 6224 - 143 0
Fax: +49 - (0) 6224 - 143 268
Web: www.LeicaBiosystems.com