

# BOND-PRIME

FULLY AUTOMATED IHC AND ISH STAINING SYSTEM

USER MANUAL

(NOT for use in China)



CE

Advancing Cancer Diagnostics  
Improving Lives

**Leica**  
BIO SYSTEMS

# Table of contents

Table of contents	2
<b>1 BOND-PRIME hardware</b>	<b>24</b>
1.1 About BOND-PRIME	25
1.1.1 BOND-PRIME ancillary materials and consumable items	26
1.2 The BOND-PRIME Processing Module	28
1.2.1 Front view	28
1.2.2 Rear view	29
1.3 The Hood	30
1.4 Preload and Unload Drawers	31
1.5 Slide Drawer Inserts, Waste Drains and Sumps, and Pickup Filter	32
1.5.1 Slide Drawer Inserts	32
1.5.2 Waste Drains	33
1.5.3 Sumps and Pickup Tube with Filter	34
1.6 Reagent Platform	35
1.7 Bulk Containers	36
1.8 Reservoir Cabinet	37
1.9 AC power switch	38
1.10 Reagent Trays	39
1.11 The Work Surface (under the Hood)	40
1.11.1 Work Surface (front view)	41
1.11.2 High-Speed Robot	42
1.11.3 Probe Selector	43
1.11.4 Wash Robots	44
1.11.5 ARC (Active Reagent Control) Modules	45
1.11.6 Wash/Prime Stations	46
1.11.7 Mixing Well Plate	47
1.11.8 Slide Preparation Station	48
1.12 Connect the processing module and switch on	49
1.13 Disconnect the processing module	51
1.14 Move a processing module to a new location	53
1.15 Decommission and dispose of a processing module	55
<b>2 Touchscreen</b>	<b>56</b>
2.1 Log in and log out	57
2.1.1 Log in	57

2.1.2 Log out .....	58
2.2 Navigation Bar .....	59
2.3 Status Screen .....	60
2.3.1 Slides Loaded Segment .....	60
2.3.2 Slides Processing Segment .....	62
2.3.3 Slides Processing Complete Segment .....	64
2.3.4 View more slide information .....	65
2.3.5 Unexpected events during processing .....	66
2.4 Action Queue and Alert Banner .....	68
2.4.1 Show and hide the Action Queue .....	68
2.4.2 Complete a task suggested in an Action Queue Item .....	69
2.4.3 Manually hide the Alert Banner .....	69
2.5 Preload slides .....	71
2.6 Preload Screen .....	73
2.6.1 Preload Drawer view .....	74
2.6.2 Preload Case view .....	76
2.7 Unload slides .....	78
2.8 Unload Screen .....	80
2.8.1 Unload Drawer view .....	81
2.8.2 Unload case view .....	82
2.9 Detailed case and slide information .....	84
2.9.1 View each slide in a case .....	86
2.9.2 Stop a slide in progress .....	87
2.10 Reagents Screen .....	88
2.10.1 Prepare Reagent Container and Reagent Trays .....	88
2.10.2 Load Reagent Trays .....	90
2.10.3 Examples of reagent system icons .....	91
2.10.4 Examples of Reagent Container icons .....	91
2.10.5 View reagent system and Reagent Container details .....	92
2.10.6 Unload Reagent Trays .....	94
2.11 Maintenance Screen .....	95
<b>3 Quick start .....</b>	<b>96</b>
3.1 Introduction .....	97
3.2 Start the processing module .....	98
3.3 Load the Reagent Tray and DS9824 Detection System .....	100
3.4 Preload, process, and unload the slides .....	102

<b>4 Cleaning and maintenance</b> .....	<b>106</b>
4.1 Maintenance schedules .....	107
4.1.1 Preventative service reminder .....	107
4.1.2 Cleaning and maintenance schedule .....	107
4.1.3 Cleaning and maintenance checklist .....	109
4.2 Refill the DI Water Container .....	110
4.3 Refill the Alcohol Container .....	112
4.4 Refill the Lot Tracked Bulk Containers .....	115
4.5 Empty the Waste Containers .....	118
4.6 Use the BOND-PRIME Cleaning Kit .....	120
4.7 Start Maintenance .....	124
4.8 Wipe internal surface of ARC Modules .....	126
4.9 Wipe down Reagent Platform and ARC Bank Surfaces .....	130
4.10 Clean the Suction Cup .....	134
4.11 Replace the Suction Cup .....	138
4.12 Clean the Slide Drawer Inserts, Waste Drains and Sumps, and Pickup Filter .....	142
4.13 Clean the Wash/Prime Stations .....	151
4.14 Use the BOND-PRIME ARC Refresh Kit .....	155
4.15 Clean the Bulk DI Water Container .....	160
4.16 Clean the Locked Bulk Reagent Containers .....	163
4.17 Clean the Waste Containers .....	173
4.18 Clean the Sump Tray .....	176
4.19 Stop maintenance .....	178
4.20 Shutdown the processing module .....	180
4.21 Replace power supply fuses .....	182
<b>5 Troubleshooting</b> .....	<b>185</b>
5.1 Failure to initialize .....	186
5.2 Network connectivity error .....	186
5.3 Manually retrieve slides from the processing module .....	186
5.3.1 Manually retrieve slides from Preload and Unload Drawers .....	187
5.3.2 Manually retrieve slides from the Work Surface .....	188
5.3.3 Manually retrieve slides from ARC Modules .....	190
5.3.4 Manually retrieve slides from ARC Modules during a power failure .....	193
5.4 Remove a slide fragment from an ARC Module .....	194

---

<b>6 Specifications</b> .....	<b>197</b>
6.1 System specifications .....	198
6.2 Physical specifications .....	198
6.3 Electrical power and UPS requirements .....	198
6.4 Environmental specifications .....	199
6.5 Operating specifications .....	199
6.6 Microscope slide specifications .....	200
6.7 Transport and storage specifications .....	201
<b>Index</b> .....	<b>202</b>

# Legal notices

## Trademarks

BOND, BOND-III, BOND-MAX, BOND-PRIME, BOND-ADVANCE, Covertile, Bond Polymer Refine Detection, Bond Polymer Refine Red Detection, Parallel Automation, Compact Polymer, and Oracle are trademarks of Leica Biosystems Melbourne Pty Ltd ACN 008 582 401.

## Copyright

Leica Biosystems Melbourne Pty Ltd owns the copyright on this document and any associated software. Under law, our written permission is required before either the documentation or the software is copied, reproduced, translated, or converted to electronic or other machine-readable form, in whole or in part.

Copyright © 2023 Leica Biosystems Melbourne Pty Ltd

## Product identification

Doc. 91.7500.501 A09

## Manufacturer



Leica Biosystems Melbourne Pty Ltd  
495 Blackburn Road  
Mount Waverley VIC 3149  
Australia

## Important information for all users

This manual contains important information on how to use BOND-PRIME. For the latest information on Leica Biosystems products and services, visit [www.leicabiosystems.com](http://www.leicabiosystems.com).

Due to a policy of continuous improvement, Leica Biosystems reserves the right to change specifications without notice.

## Terminology

The following terms are used in this document:

- Leica Biosystems—refers to Leica Biosystems Melbourne Pty Ltd.
- BOND - the Leica Biosystems platform that includes the BOND-III, BOND-MAX, and BOND-PRIME
- BOND-PRIME - a type of automated IHC and ISH staining instrument
- BOND software - the software application through which users can configure and operate the BOND-III, BOND-MAX, or BOND-PRIME system

## Intended users

The intended users of BOND-PRIME are adequately trained laboratory personnel.

Persons operating a BOND-PRIME Processing Module must have received sufficient training to ensure that it is used in accordance with this document and be fully aware of any potential hazards or hazardous procedures, before operating the processing module. Only trained staff are to remove any covers or parts from the processing module, and only if instructed within this manual.

## Installation and repairs

Installation and repairs must only be carried out by qualified service personnel authorized by Leica Biosystems.

Warranty claims can be made only if the product has been used for the specified application and operated according to the instructions in this document. Damage resulting from inappropriate handling and/or misuse of the product will invalidate the warranty. Leica Biosystems cannot assume liability for any such damage.

## Serious incident reporting

The occurrence of any serious incident(s) that either has led to, or may lead to, death of a patient or user, or the temporary or permanent deterioration in the state of health of a patient or user must be reported to a local Leica Biosystems representative and the relevant local Regulatory Authority.

## Statement for User Data Security and Privacy

Leica Biosystems respects, and is committed to protecting, personal data security and privacy. The Leica Biosystems Privacy Notice below describes the personal data that we may collect, use and retain.

## Privacy Notice

The licensee shall comply with all applicable data protection and privacy laws in processing personal data using the BOND-PRIME, without limitation, by making all required notifications to, and obtaining all required consents from, patients and other data subjects prior to processing their personal data.

The following types of Personal Data exist on the BOND-PRIME Processing Module:

- **Patient Name** – is held temporarily on the BOND-PRIME for tracking the run details of the slide whilst the slide is processed.
- **Doctor Name** – is held temporarily on the BOND-PRIME for tracking the run details of the slide whilst the slide is processed.
- **Slide ID** – is held temporarily on the BOND-PRIME for tracking the run details of the slide whilst the slide is processed.
- **User account details** – User account details are encrypted in the data files and retained in the BOND Controller until deleted by a Supervisor. No user data is stored on the BOND-PRIME Processing Module.
- **Slide Images** – Images of processed slides are collected for tracking the run details of the slide. Slide images are encrypted in the data files and retained on the BOND Controller indefinitely. The images are automatically removed from the BOND-PRIME Processing Module after one day.

# Contacting Leica Biosystems

For service or support contact your local Leica Biosystems representative or see [www.LeicaBiosystems.com](http://www.LeicaBiosystems.com).



# Revision record

Rev	Issued	Sections affected	Detail
A09	December 2023	Regulatory notices Glossary of symbols 1.1 About BOND-PRIME 4.1 Maintenance schedules 4.14 Use the BOND-PRIME ARC Refresh Kit	Minor corrections.
A08	May 2023	Legal notices 4.14 Use the BOND-PRIME ARC Refresh Kit	Minor corrections.
A07	January 2023	All 4.14 Use the BOND-PRIME ARC Refresh Kit 6 Specifications 5 Troubleshooting Legal notices	Changed layout of the manual. Added slide count equivalency table. Enhanced slide specifications image. Added Service life and cybersecurity certificate life. Added Troubleshooting chapter. Added Statement of Intended Use of Personal Data.
A06	July 2022	2.10.4 Examples of Reagent Container icons 4.14 Use the BOND-PRIME ARC Refresh Kit 4.1 Maintenance schedules	Removed obsolete reagent container icons. ARC Refresh kit maintenance period changed to 4 months.
A05	April 2022	1.8 Reservoir Cabinet 1.9 AC power switch 1.4 Preload and Unload Drawers 2.5 Preload slides 2.6 Preload Screen 2.7 Unload slides 2.8 Unload Screen 3.4 Preload, process, and unload the slides 4.12 Clean the Slide Drawer Inserts, Waste Drains and Sumps, and Pickup Filter 4.14 Use the BOND-PRIME ARC Refresh Kit 4.16 Clean the Locked Bulk Reagent Containers 1.11.4 Wash Robots 5.3.3 Manually retrieve slides from ARC Modules 1 BOND-PRIME hardware 4.21 Replace power supply fuses 1.2 The BOND-PRIME Processing Module	Updated images of Reservoir Cabinet. Updated images of Preload and Unload Drawers. Updated image to remove and install Covertile. Added information about refilling the containers. Added notes about being able to manually move Wash Robots. Removed part numbers.
A04	January 2022	5.3 Manually retrieve slides from the processing module Glossary of symbols All	Added instructions for removing slides from the processing module. Updated Glossary of Symbols. Updated Intended Use statement.

Rev	Issued	Sections affected	Detail
			Various corrections and updates to reflect the latest touchscreen interface and to improve the usability of the manual. Removed Clean the Slide Preparation section.
A03	June 2021	Front cover General cautions 1.1 About BOND-PRIME 1.2 The BOND-PRIME Processing Module 1.7 Bulk Containers 1.11 The Work Surface (under the Hood) 1.11.6 Wash/Prime Stations 1.11.8 Slide Preparation Station 2.3 Status Screen 2.3.1.1 Slides not accepted 2.3.5 Unexpected events during processing 2.4 Action Queue and Alert Banner 2.5 Preload slides 3 Quick start 3.2 Start the processing module 4.1 Maintenance schedules 4.2 Refill the DI Water Container 4.4 Refill the Lot Tracked Bulk Containers 4.5 Empty the Waste Containers 4.6 Use the BOND-PRIME Cleaning Kit 4.8 Wipe internal surface of ARC Modules 4.14 Use the BOND-PRIME ARC Refresh Kit 4.11 Replace the Suction Cup 4.13 Clean the Wash/Prime Stations 4.12 Clean the Slide Drawer Inserts, Waste Drains and Sumps, and Pickup Filter 4.15 Clean the Bulk DI Water Container 4.16 Clean the Locked Bulk Reagent Containers 4.17 Clean the Waste Containers 4.18 Clean the Sump Tray 6 Specifications	Rebranding. Various corrections, updates and additions etc. in all listed sections affected.
A02	April 2021	All	First release.
A01	-	-	Not released.

# Regulatory notices

## Intended purpose

**IVD**

The BOND system automates clinical protocols for immunostaining of pathology specimens mounted on microscope slides. Microscope slides subsequently undergo interpretation by a qualified healthcare professional to aid diagnosis.

## FCC compliance

This equipment has been tested and found to comply with the limits for a Class A digital device, pursuant to part 15 subpart B of the FCC Rules. These limits are designed to provide reasonable protection against harmful interference when the equipment is operated in a commercial environment. This equipment generates, uses, and can radiate radio frequency energy and, if not installed and used in accordance with the instruction manual, may cause harmful interference to radio communications. Operation of this equipment in a residential area is likely to cause harmful interference in which case the user will be required to correct the interference at his own expense.

To maintain compliance use only the cables supplied with the instrument.



**WARNING:** Any changes or modifications not expressly approved by Leica Biosystems could void the user's authority to operate this equipment.

## CE marking



The CE Mark signifies compliance with the applicable EU Directives as listed on the manufacturer declaration of conformity.

## Instructions for in vitro diagnostic equipment for professional use

This IVD equipment complies with the emission and immunity requirements of IEC 61326 part 2-6 and IEC 60601 part 1-2.

The electromagnetic environment should be evaluated prior to operation of the device.

Do not use this device in close proximity to sources of strong electromagnetic radiation (e.g. unshielded intentional RF sources) and/or magnetic fields, as these can interfere with the proper operation.



**WARNING:** This equipment was designed and tested to CISPR 11 Class A. In a domestic environment it may cause radio interference, in which case you may need to take measures to mitigate the interference.

Computer regulatory requirements: UL Listed (UL 60950), IEC 60950 certified.



**CAUTION:** Federal Law restricts this device to sale by or on the order of a licensed healthcare practitioner.

## Classification of equipment under CISPR 11 (EN 55011)

This equipment is classified as Group 1 Class A under CISPR 11 (EN 55011). The explanation for group and class is described below.

**Group 1** - This is applicable for all equipment which is not classified as group 2 equipment.

**Group 2** - This is applicable for all ISM RF equipment in which radio - frequency energy in the frequency range 9 kHz to 400 GHz is intentionally generated and used or only used, in the form electromagnetic radiation, inductive and/ or capacitive coupling, for the treatment of material or inspection/ analysis purposes.

**Class A** - This is applicable for all equipment suitable for use in all establishments other than domestic and those directly connected to a low voltage power supply network which supplies buildings used for domestic purposes.

**Class B** - This is applicable for all equipment suitable for use in domestic establishments and in establishments directly connected to a low voltage power supply network which supplies buildings used for domestic purposes.

## Definitions

ISM: Industrial, Scientific and Medical

RF: Radio Frequency

# Glossary of symbols

This section describes the regulatory and safety symbols used in the product labeling.

## Regulatory symbols

Explanation of the regulatory symbols used for BOND.











This glossary provides images of the symbols as presented in the relevant standards, however, some of the symbols may vary in color.

The following is a list of symbols used on the product labeling and their meaning.

### ISO 15223-1

Medical devices – symbols to be used with medical device labels, labeling and information to be supplied – Part 1: General requirements.



Symbol	Standard/ Regulation	Reference	Description
	ISO 15223-1	5.1.1	<b>Manufacturer</b> Indicates the medical device manufacturer.
	ISO 15223-1	5.1.2	<b>Authorized representative in the European community</b> Indicates the Authorized representative in the European Community.
	ISO 15223-1	5.1.3	<b>Date of manufacture</b> Indicates the date when the medical device was manufactured.
	ISO 15223-1	5.1.4	<b>Use by (expiration date)</b> Indicates the date after which the medical device is not to be used.
	ISO 15223-1	5.1.5	<b>Batch code</b> Indicates the manufacturer's batch code so that the batch or lot can be identified.
	ISO 15223-1	5.1.6	<b>Catalog number / Reference number</b> Indicates the manufacturer's catalog number so that the medical device can be identified.
	ISO 15223-1	5.1.7	<b>Serial number</b> Indicates the manufacturer's serial number so that a specific medical device can be identified.

Symbol	Standard/ Regulation	Reference	Description
	ISO 15223-1	5.1.8	<b>Importer</b> Indicates the entity importing the medical device into the European Union.
	ISO 15223-1	5.1.9	<b>Distributor</b> Indicates the entity distributing the medical device into the locale.
	ISO 15223-1	5.3.1	<b>Fragile: handle with care</b> Indicates a medical device that can be broken or damaged if not handled carefully.
	ISO 15223-1	5.3.4	<b>Keep away from rain</b> Indicates that the transport package shall be kept away from rain and in dry conditions.
	ISO 15223-1	5.3.7	<b>Temperature limit</b> Indicates the temperature limits to which the medical device can be safely exposed.
	ISO 15223-1	5.4.2	<b>Do not re-use</b> Indicates a medical device that is intended for one use, or for use on a single patient during a single procedure.
	ISO 15223-1	5.4.3	<b>Consult instructions for use</b> Indicates the need for the user to consult the instructions for use.
	ISO 15223-1	5.4.4	<b>Caution</b> Indicates the need for the user to consult the instructions for use for important cautionary information such as warnings and precautions that cannot, for a variety of reasons, be presented on the medical device itself.
	ISO 15223-1	5.5.1	<b>In Vitro Diagnostic medical device</b> Indicates a medical device that is intended to be used as an in vitro diagnostic medical device.

## ISO 7000



Graphical symbols for use on equipment – Registered symbols.



Symbol	Standard/ Regulation	Reference	Description
	ISO 7000	1135	<b>Recycle</b> Indicates that the marked item or its material is part of a recovery or recycling process.

Symbol	Standard/ Regulation	Reference	Description
	ISO 7000	1640	<b>Technical manual: manual for service</b> Identifies the location where the handbook is stored or to identify information that relates to the servicing instructions for the equipment. To indicate that the service manual or handbook should be considered when servicing the device close to where the symbol is placed.
	ISO 7000	2594	<b>Ventilation open</b> Identifies the control that allows outside air into interior environment.
	ISO 7000	3650	<b>USB</b> Identifies a port or plug as meeting the generic requirements of the Universal Serial Bus (USB). To indicate that the device is plugged into a USB port or is compatible with a USB port.

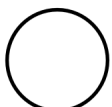
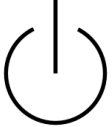
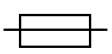

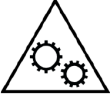

## IEC 60417

Graphical symbols for use on equipment.









Symbol	Standard/ Regulation	Reference	Description
	IEC 60417	5007	<b>On</b> Indicates connection to the mains, at least for mains switches or their positions, and all those cases where safety is involved
	IEC 60417	5008	<b>Off</b> Indicates disconnection from the mains, at least for mains switches or their positions, and all those cases where safety is involved
	IEC 60417	5009	<b>Stand-by</b> Identifies the switch or switch position by means of which part of the equipment is switched on in order to bring it into the standby condition
	IEC 60417	5016	<b>Fuse</b> Identifies fuse boxes or their location.
	IEC 60417	5019	<b>Protective earth: protective ground</b> A terminal that is intended for connection to an external conductor for protection against electric shock in case of a fault, or the terminal of a protective earth (ground) electrode.
	IEC 60417	5032	<b>Single phase alternating current</b> Indicates on the rating plate that the equipment is suitable for alternating current only; to identify relevant terminals.

Symbol	Standard/ Regulation	Reference	Description
	IEC 60417	5988	<b>Computer network</b> Identifies the computer network itself or to indicate the connecting terminals of the computer network.
	IEC 60417	6057	<b>Caution: moving parts</b> An instructional safeguard to keep away from moving parts.
	IEC 60417	6222	<b>Information: general</b> Identifies the control to examine the status of the equipment, e.g. multifunctional copying machines

## Other symbols and markings

Symbol	Standard/ Regulation	Description
	21 CFR 801.15(c)(1) (i)F	<b>Prescription only</b> Recognized by the US FDA as an alternate to "Caution: Federal law restricts this device to sale by or on the order of a licensed practitioner."
	The instrument Declaration of Conformity lists the Directives with which the system complies	<b>European Conformity</b> The instrument Declaration of Conformity lists the Directives with which the system complies.
	Directive 2012/19/EC EU: waste electrical and electronic equipment (WEEE)	<b>Waste Electrical and Electronic Equipment (WEEE) Directive</b> The electronic product should not be discarded as unsorted waste but must be sent to separate collection facilities for recovery and recycling.  The presence of this label indicates that: <ul style="list-style-type: none"> <li>• The device was put on the European Market after August 13, 2005.</li> <li>• The device is not to be disposed of via the municipal waste collection system of any member state of the European Union.</li> </ul> Customers must understand and follow all laws regarding the correct decontamination and safe disposal of electrical equipment.
	AS/NZS 4417.1	<b>Regulatory Compliance Mark (RCM)</b> Indicates compliance with the Australian Communications Media Authority (ACMA) requirements (safety and EMC) for Australia and New Zealand.

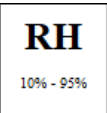









Symbol	Standard/ Regulation	Description
	People's Republic of China Electronic Industry Standard SJ/T11364	<b>Restriction of Hazardous Substances (RoHS 2)</b> Indicates that this electronic information product contains certain toxic or hazardous elements, and can be used safely during its environmental protection use period. The number in the middle of the logo indicates the environmental protection use period (in years) for the product. The outer circle indicates that the product can be recycled. The logo also signifies that the product should be recycled immediately after its environmental protection use period has expired. The date on the label indicates the date of manufacture.
	People's Republic of China Electronic Industry Standard SJ/T11364	<b>Restriction of Hazardous Substances (RoHS 2)</b> Indicates that this electronic information product does not contain any hazardous substances, or they do not exceed the concentration limits specified in GB/T 26572. It is a green environmentally friendly product that can be recycled.
	Title 47 United States Code of Federal Regulations Part 15	<b>Federal Communications Commission (FCC)</b> This product has been tested and found to comply with the limits pursuant to part 15 of the FCC Rules.
	N/A	<b>Underwriters Laboratory (UL) certification mark</b> Underwriter Laboratories have certified that the listed products comply with both US and Canadian safety requirements.
	CSA International	<b>Listed device with CSA Group testing agency</b> CSA Group have certified that the listed products comply with both US and Canadian safety requirements.
	N/A	<b>Listed device with Intertek testing agency</b> Intertek Testing Agency have certified that the listed products comply with both US and Canadian safety requirements.
	Ordinance on In Vitro Diagnostic Medical Devices (IVDO) of 4 May 2022.	<b>Swiss Authorised Representative</b> Indicates the Swiss Authorised representative.
	N/A	<b>Relative humidity range</b> Indicate the acceptable upper and lower limits of relative humidity for transport and storage. This symbol is accompanied by the applicable relative humidity limits.
	N/A	<b>Unconnected port</b> This product has an unconnected port on the syringe pump.





# Safety symbols

Explanation of the safety symbols used for BOND.

## ISO 7010

Graphical symbols – Safety colors and safety signs – Registered safety signs.

Symbol	Standard/ Regulation	Reference	Description
	ISO 7010	W001	<b>General warning</b> Indicates the need for the user to consult the instructions for use for important cautionary information such as warnings and precautions that cannot, for a variety of reasons, be presented on the medical device itself.
	ISO 7010	W004	<b>Warning: laser beam</b> Laser hazard. Potential for severe eye damage. Avoid direct eye contact with laser beams.
	ISO 7010	W007	<b>Warning: floor-level obstacle</b> Floor-level obstacle hazard. Take care when in the vicinity of a floor-level obstacle.
	ISO 7010	W009	<b>Warning: biological hazard</b> Biological hazard. Potential exposure to a biological hazard. Follow directions in the accompanying documentation to avoid exposure.
	ISO 7010	W012	<b>Caution: risk of electric shock</b> Electrical hazard. Potential risk of electric shock. Follow directions in the accompanying documentation to avoid damage to persons or equipment.
	ISO 7010	W016	<b>Warning: toxic material</b> Toxic hazard. Potential danger of severe health impacts if proper chemical handling procedures are not followed. Use gloves and protective eye wear when handling reagents.
	ISO 7010	W017	<b>Warning: hot surface</b> Heat hazard. Hot surfaces will cause burns if touched. Avoid touching parts identified with this symbol.
	ISO 7010	W020	<b>Warning: Overhead obstacle</b> Overhead obstacle. Take care to avoid being struck by or walking into an overhead obstacle.
	ISO 7010	W021	<b>Warning: flammable material</b> Flammable hazard. Flammable materials may ignite if proper precautions are not followed.

Symbol	Standard/ Regulation	Reference	Description
	ISO 7010	W022	<b>Warning: Sharp element</b> Sharp element. Take care to avoid injury from sharp elements (e.g. needles, blades).
	ISO 7010	W023	<b>Warning: corrosive substance</b> Chemical hazard from a corrosive substance. There is a danger of severe health impacts if proper precautions are not followed. Always wear protective clothing and gloves. Immediately clean up spills using standard laboratory practice.
	ISO 7010	W024	<b>Warning: crushing of hands</b> Crush hazard. Hands or body parts can be crushed by a closing motion of mechanical parts of equipment.
	ISO 7010	W072	<b>Warning: Environmental hazard</b> Environmental hazard. Substance or mixture that can cause an environmental hazard.

## General warnings

Warnings are notifications of hazards that could lead to personal injury, or where there is the possibility of losing, damaging, or misidentifying patient samples. Follow all safety precautions to avoid personal injury, damage, loss or misidentification of patient samples, and damage to equipment.

Warnings use symbols with a black border and yellow background.

General BOND-PRIME warnings appear below. Other warnings appear in the relevant sections in the manual.

## Processing module operation



To make sure that the BOND-PRIME Processing Module operates correctly, always obey the approved instructions from Leica Biosystems Melbourne Pty Ltd. If you do not obey instructions correctly, this can cause unsatisfactory performance.



BOND-PRIME does not require network access to function and perform its intended use. To prevent malicious or unauthorized access, install BOND-PRIME without any connection to your network / infrastructure.

If you would like network connection, the preferred method is to connect BOND-PRIME to a fire walled Virtual Local Area Network (VLAN). Alternatively, you can implement and validate your own network security mechanisms in accordance with your standard operating procedures.

For more information, refer to the *BOND 7+ Information Systems Guide* (49.6539.811).



A malware infection on a BOND controller could lead to unexpected behaviors in operation, including disabling processing modules. Take care to ensure your USB storage devices are virus free before connecting them to the BOND controller. Further, Leica Biosystems Melbourne Pty Ltd does not pre-install an anti-virus solution; we recommend that you install your own enterprise anti-virus product. Contact your local Leica Biosystems Melbourne Pty Ltd representative for further information.

---

## Electrical hazards



Only remove the processing module covers or try to access internal components if this document tells you to do so. There are dangerous voltages inside the processing module. Only qualified service technicians approved by Leica Biosystems Melbourne Pty Ltd must do electrical work.

---



Do not change the processing module's operating voltage. If you connect the processing module to an incorrect power-supply voltage, this can cause damage to the processing module.

Notify customer support if it is necessary to change the setting.

---



You must connect the processing module to an earthed power-outlet socket, which must be easily accessible.

---



Do not bypass or short-circuit fuses.

Before you replace a fuse, set the AC power switch on the processing module to OFF and disconnect the power-supply cable from the rear cover of the processing module. Use only approved replacement fuses. If it is necessary to regularly replace fuses, notify customer support.

---

## Chemical hazards



Make sure that you correctly install the caps on removable bulk containers and reservoirs.

Do not let a flame or other source of ignition near the processing module. Some of the reagents in the bulk containers and reservoirs are flammable.

---



To prevent a fire, do not put flammable material on or near hot surfaces on the processing module.

---

## Mechanical hazards



Use both hands when you lift the DI Water and Bulk/Hazardous Waste Containers for cleaning and maintenance tasks.



Before you try to operate the processing module, close the Hood. The processing module has interlocks that prevent operation when the Hood is open. Do not try to bypass the interlocks.



If the High-Speed Robot gets stuck in a position above the Work Surface, do not attempt to manually move it. Contact customer support about the problem.



When you close the Hood, make sure that your hands are away from the opening. The Hood is heavy and can cause injury.

While the processing module operates, the Hood is locked in the closed position. Do not try to open the Hood.



The High-Speed Robot and Wash Robots must not continue to operate when the Hood is open. If they do continue to operate, immediately notify customer support about the problem.



While the processing module operates, do not put your hands inside the Reagent Platform opening. The High-Speed Robot can move quickly and suddenly during operation.



If you need to move a processing module a long distance to a new location, notify customer support. The processing module is very heavy. Only approved personnel must move the processing module.

## Processing module operation



To prevent contamination of reagents and slides, only operate the processing module in a clean environment as free as possible from dust and particulate matter.



To prevent contamination and unsatisfactory performance, make sure that you correctly install the Bulk Containers. The Bulk Container stations have color-coded name labels.

Refer to [1.7 Bulk Containers](#).

# General cautions

Cautions are notifications of hazards that could lead to damage to the BOND equipment or other adverse consequences that do not endanger people.

Cautions use symbols with a black border and white background

General BOND-PRIME cautions appear below. Other cautions appear in relevant sections in the manual.

## Personal Protective Equipment (PPE)

You must wear the minimum required PPE before you use reagents, operate, maintain or clean the processing module:

- Laboratory gloves
- Safety glasses
- Suitable protective clothing, for example a lab coat

## Installation hazards



Do not seal the ventilation openings on the rear cover of the processing module.

---

## Operational hazards



Position all parts of the slide label within all slide edges. An exposed sticky surface can cause the slide label (and slide) to stick to the Covertile or other equipment and damage the slide.

---



Do not leave any moisture or sticky residue on the slide label area as it can cause damage.

---



You must clean removable parts by hand only. To prevent damage, do not clean parts in an automatic dishwasher. Do not use solvents or harsh or abrasive materials to clean parts.

---



Do not use force when you install bulk containers. This can cause damage to the container.

---



Do not use damaged slides.

---

## Reagent hazards

---



Bulk reagents that are not compatible can cause unsatisfactory performance and damage to the processing module.

Refer to Leica Biosystems Melbourne Pty Ltd for information about compatible bulk reagents.

---



Do not use xylene, chloroform, acetone, strong acids (for example 20% HCl), strong alkalis (for example 20% NaOH) on BOND-PRIME Processing Modules.

If there is a spill of these chemicals on or near a processing module, clean the area immediately with 70% ethanol to prevent damage to the processing module covers.

---



Use only BOND-PRIME Dewax Solution, BOND-PRIME ER1, BOND-PRIME ER2 Solutions and BOND-PRIME Wash Solution Concentrate on BOND-PRIME Processing Modules.

Do not use xylene, xylene substitutes and other reagents that can degrade parts of the BOND-PRIME Processing Module and cause fluid leaks.

---

# 1

# BOND-PRIME hardware

In this section:

1.1 About BOND-PRIME .....	25
1.2 The BOND-PRIME Processing Module .....	28
1.3 The Hood .....	30
1.4 Preload and Unload Drawers .....	31
1.5 Slide Drawer Inserts, Waste Drains and Sumps, and Pickup Filter .....	32
1.6 Reagent Platform .....	35
1.7 Bulk Containers .....	36
1.8 Reservoir Cabinet .....	37
1.9 AC power switch .....	38
1.10 Reagent Trays .....	39
1.11 The Work Surface (under the Hood) .....	40
1.12 Connect the processing module and switch on .....	49
1.13 Disconnect the processing module .....	51
1.14 Move a processing module to a new location .....	53
1.15 Decommission and dispose of a processing module .....	55



# 1.1 About BOND-PRIME

The intended users of BOND-PRIME are adequately trained laboratory personnel.

The BOND-PRIME has these primary components:

- One or more processing modules
- A BOND Controller or a BOND-ADVANCE Controller.



A BOND-ADVANCE System also has Terminals, and can include a secondary (backup) Controller.

- One or more hand-held Barcode Scanners
- One or more Slide Labelers.

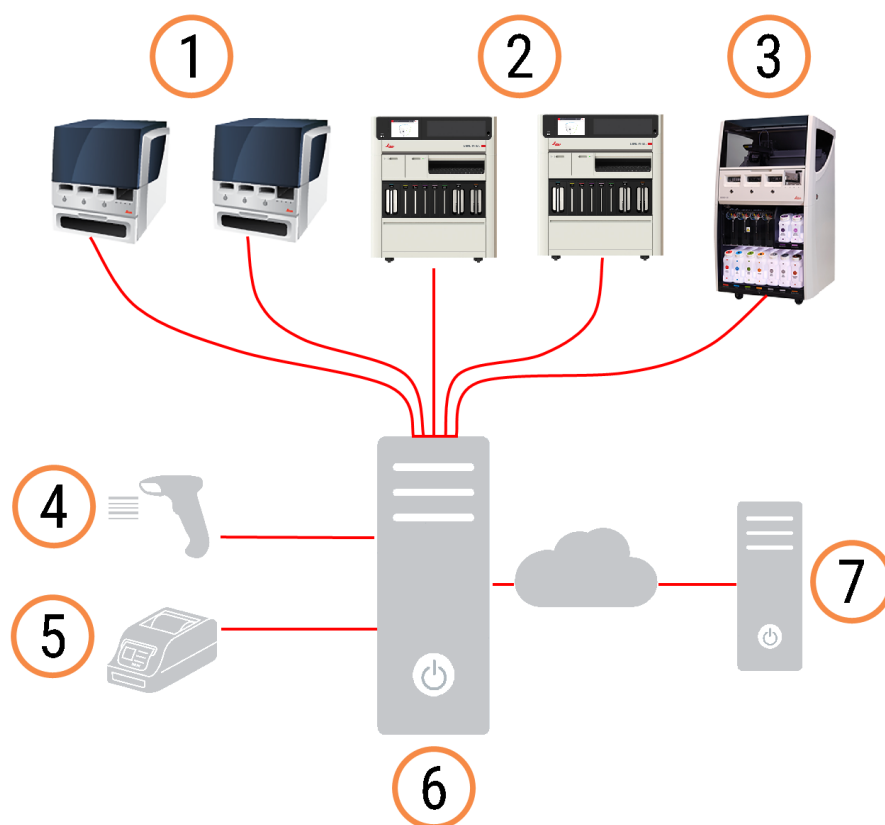

## Legend

1	BOND-MAX Processing Module	5	Slide Label Printer
2	BOND-PRIME Processing Module	6	BOND Controller
3	BOND-III Processing Module	7	LIS connection
4	Handheld Barcode scanner		

Each new BOND-PRIME Processing Module has:

- Removable Preload Slide Drawer Insert
- Removable Unload Slide Drawer Insert
- Single Reagent Trays
- Ethernet cable.

Other necessary items are:

- BOND-PRIME Detection Systems
- BOND-PRIME Ready-To-Use (RTU) reagents or concentrates
- BOND-PRIME Open Containers.

Refer to [www.leicabiosystems.com](http://www.leicabiosystems.com) for a full and up-to-date list of consumable items and spare parts.

## 1.1.1 BOND-PRIME ancillary materials and consumable items

Leica Biosystems Melbourne Pty Ltd supplies the following ancillary materials for use with the BOND-PRIME Processing Module.

To get best-quality stained slides and to prevent damage, do not use alternative ancillary materials.

### Ancillary reagents

- BOND-PRIME Dewax Solution
- BOND-PRIME Wash Solution Concentrate
- BOND-PRIME Epitope Retrieval Solution 1
- BOND-PRIME Epitope Retrieval Solution 2
- BOND-PRIME Hematoxylin
- BOND-PRIME Cleaning Kit

### Consumable items

- BOND Plus Slides or acceptable glass slides (refer to [6.6 Microscope slide specifications](#))
- BOND Open Containers (7 mL), 10 pack
- BOND Open Containers (30 mL), 10 pack
- BOND Titration Kit, 10 containers, 50 inserts
- BOND Slide Label and Print Ribbon Kit

- BOND-PRIME ARC Refresh Kit:
  - 24 ARC Covertiles
  - 1 Mixing Well Plate

## Spares

- BOND-PRIME Suction Cups

## Required Reagents (not supplied by Leica Biosystems Melbourne Pty Ltd)

- Reagent-grade alcohol
- DI water

## 1.2 The BOND-PRIME Processing Module

### 1.2.1 Front view

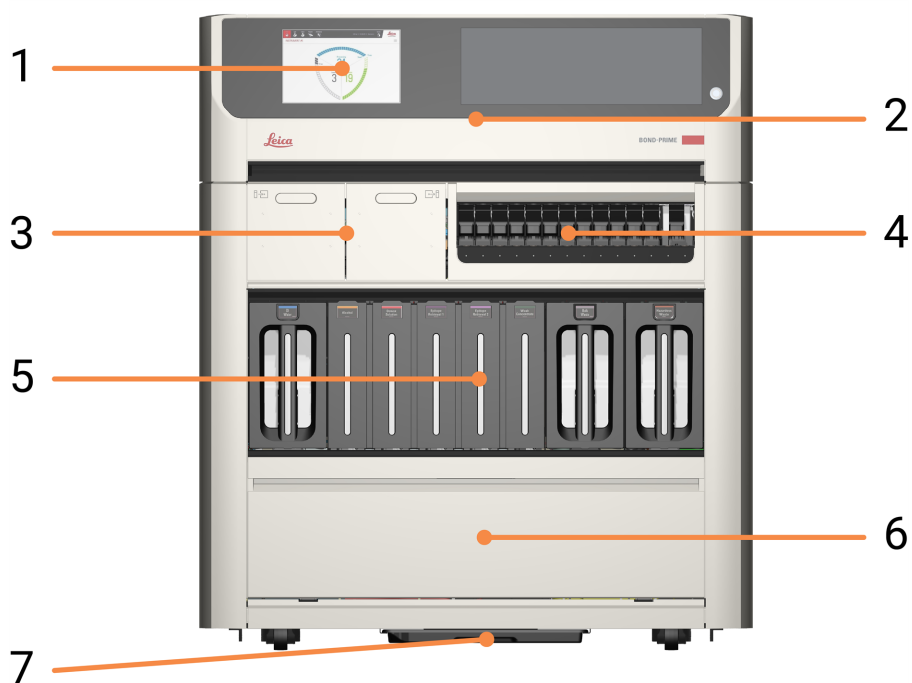

#### Legend

---

1	2 Touchscreen	5	1.7 Bulk Containers
2	1.3 The Hood	6	1.8 Reservoir Cabinet
3	1.4 Preload and Unload Drawers	7	Sump Tray
4	1.6 Reagent Platform		

---

## 1.2.2 Rear view

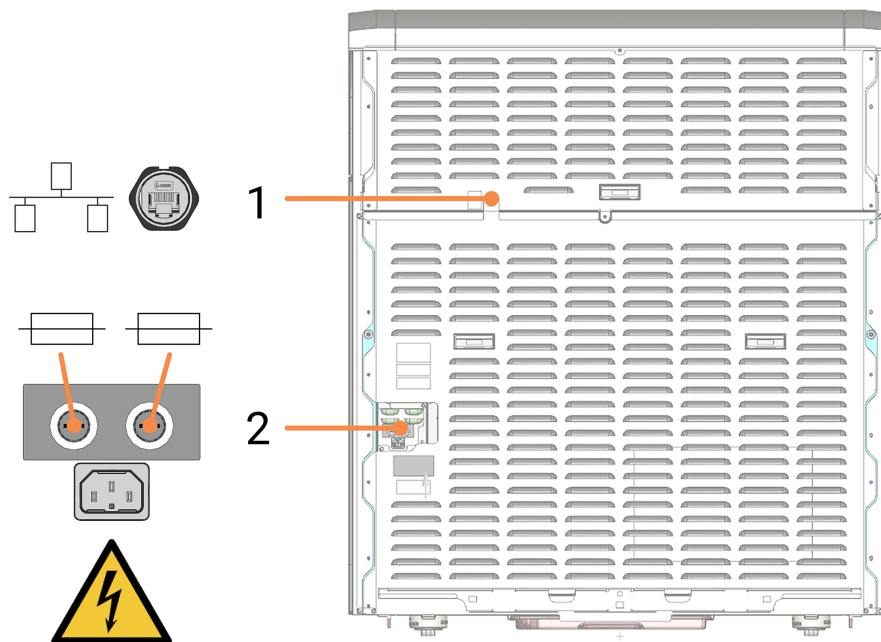

### Legend

- 1 Ethernet connection
- 2 Fuses and power-supply connection



## 1.3 The Hood

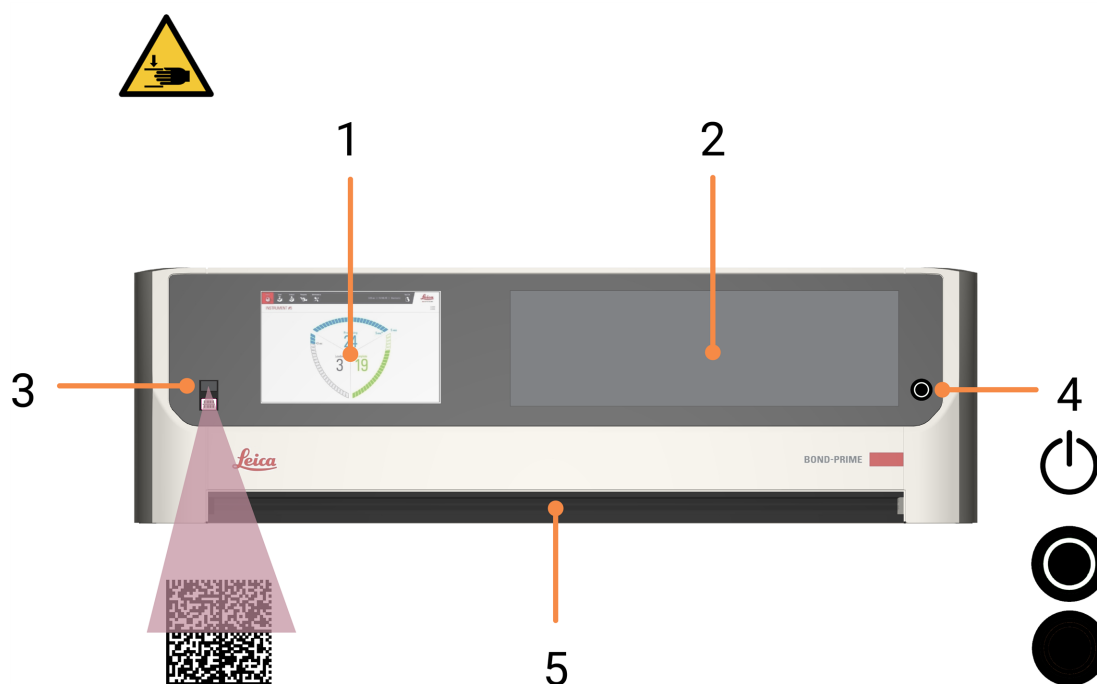

### Legend

- |                                                                                                                                                                                                                                                        |                                                                                                                                                                                        |
|--------------------------------------------------------------------------------------------------------------------------------------------------------------------------------------------------------------------------------------------------------|----------------------------------------------------------------------------------------------------------------------------------------------------------------------------------------|
| <p>1 <b>2 Touchscreen</b></p> <p>2 <b>Viewing window</b><br/>Allows you to see the Work Surface while the processing module is in operation.</p> <p>3 <b>Barcode Scanner</b><br/>Used to scan bulk reagent supply bottles and the ARC Refresh Kit.</p> | <p>4 <b>Standby power button with white LED</b><br/>Indicates when the processing module is on (white) or off (unlit).</p> <p>5 <b>Handle</b><br/>Used to open and close the Hood.</p> |
|--------------------------------------------------------------------------------------------------------------------------------------------------------------------------------------------------------------------------------------------------------|----------------------------------------------------------------------------------------------------------------------------------------------------------------------------------------|

## 1.4 Preload and Unload Drawers

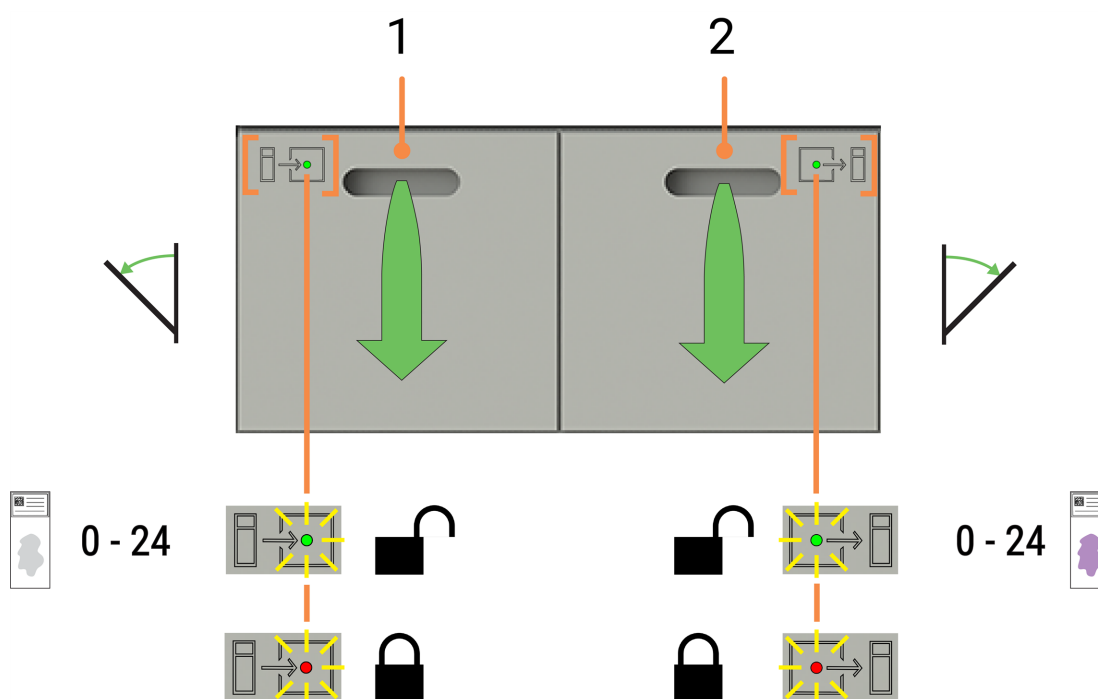

### Legend

- |   |                |
|---|----------------|
| 1 | Preload Drawer |
| 2 | Unload Drawer  |

### See also:

- [2.5 Preload slides](#)
- [2.7 Unload slides](#)
- [4.12 Clean the Slide Drawer Inserts, Waste Drains and Sumps, and Pickup Filter](#)

## 1.5 Slide Drawer Inserts, Waste Drains and Sumps, and Pickup Filter

### 1.5.1 Slide Drawer Inserts

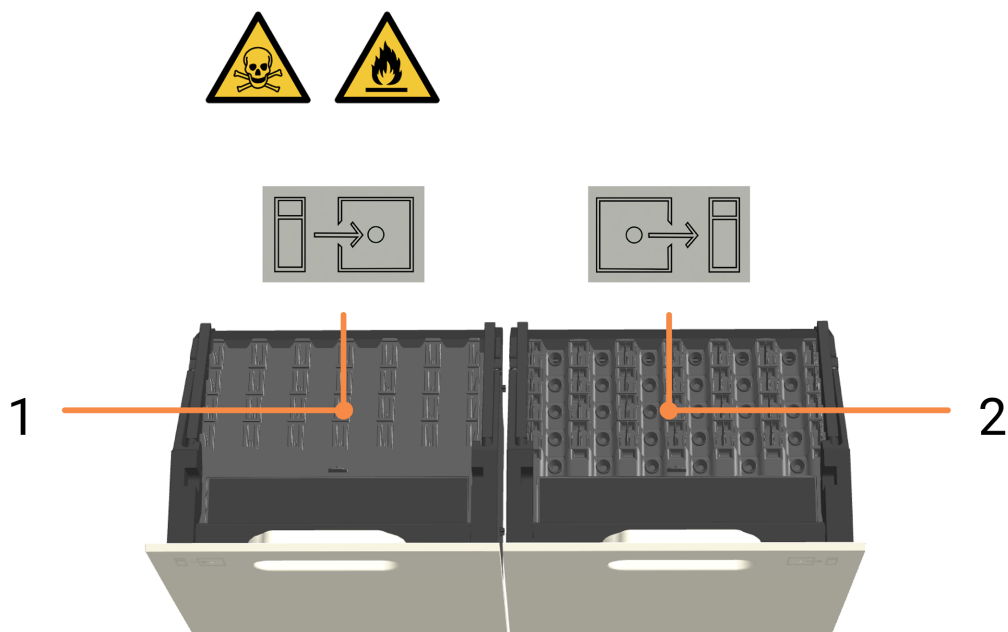

#### Legend

- |   |                             |
|---|-----------------------------|
| 1 | Preload Slide Drawer Insert |
| 2 | Unload Slide Drawer Insert  |

#### See also:

- [2.5 Preload slides](#)
- [2.7 Unload slides](#)
- [4.12 Clean the Slide Drawer Inserts, Waste Drains and Sumps, and Pickup Filter](#)



## 1.5.2 Waste Drains

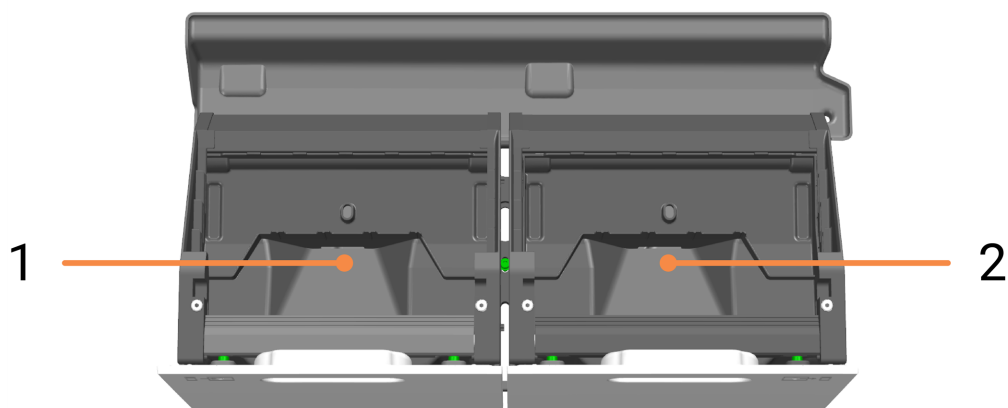

### Legend

- 
- 1 Preload Waste Drain
  - 2 Unload Waste Drain
- 

The Waste Drains are accessible after removal of the Slide Drawer Inserts from the opened drawers.

### See also:

- [4.12 Clean the Slide Drawer Inserts, Waste Drains and Sumps, and Pickup Filter](#)

## 1.5.3 Sumps and Pickup Tube with Filter

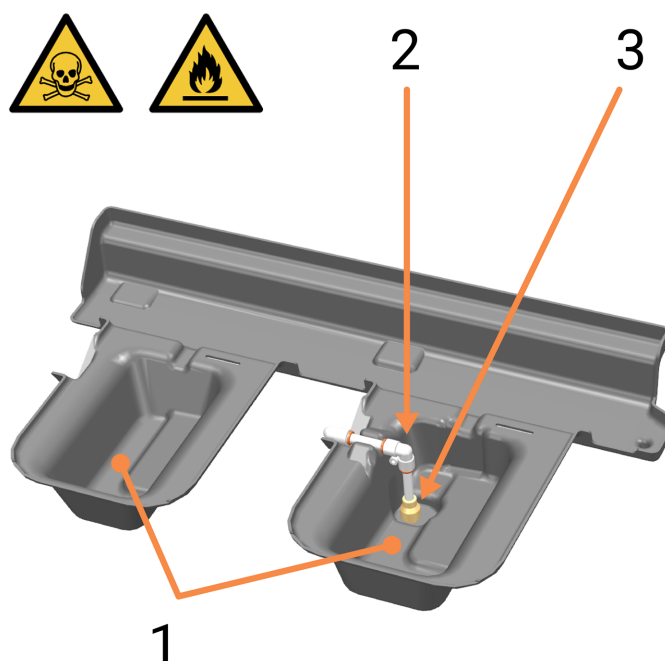

### Legend

- 1 Sumps
- 2 Unload Drawer Pickup Tube
- 3 Pickup Filter

The Sumps are located under and behind the Preload and Unload Drawers. They are accessible via the Work Surface after fully opening the drawers.

In the Sump under the Unload Drawer, the Pickup Tube and Filter are used to extract the waste water that collects when the Unload Drawer is opened and closed.

If there is liquid build up in a Sump, it might be because the Pickup Filter is blocked. Refer to [4.12 Clean the Slide Drawer Inserts, Waste Drains and Sumps, and Pickup Filter](#).

### See also:

- [4.12 Clean the Slide Drawer Inserts, Waste Drains and Sumps, and Pickup Filter](#)

## 1.6 Reagent Platform

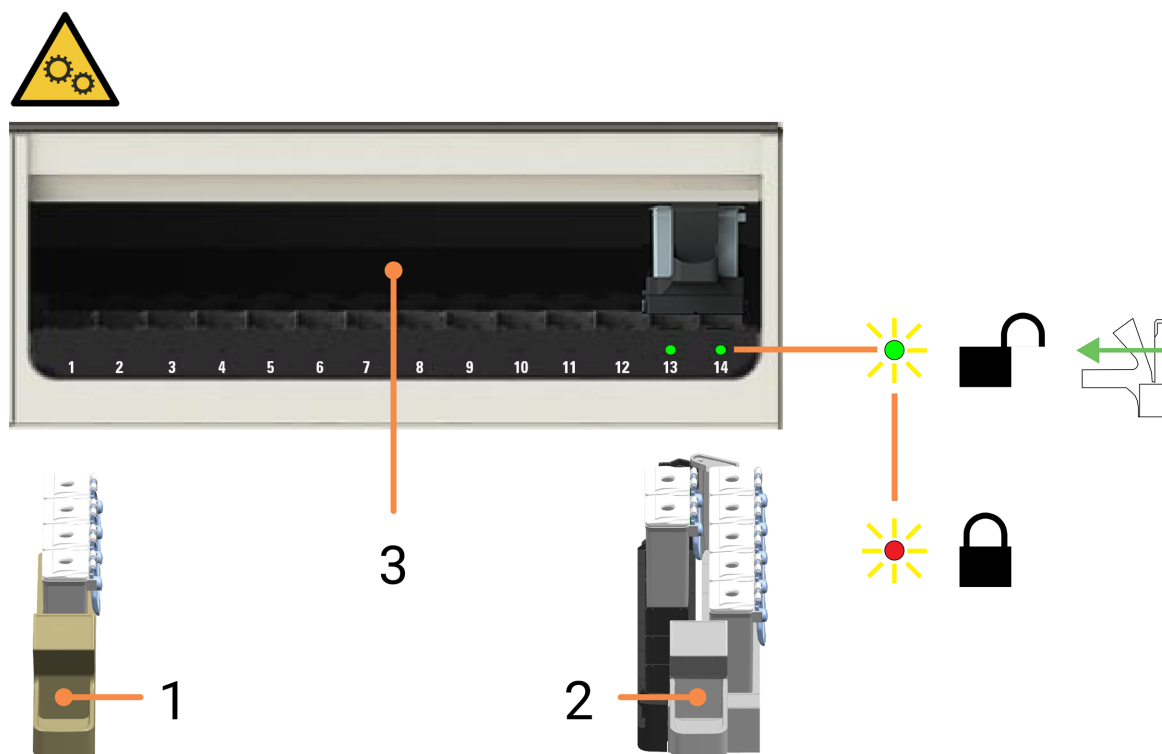

### Legend

- |   |                     |   |                                                                                                                                |
|---|---------------------|---|--------------------------------------------------------------------------------------------------------------------------------|
| 1 | Single Reagent Tray | 3 | Reagent Platform with 14 lanes<br>(total capacity of 70 reagent containers,<br>in any combination of single and dual<br>trays) |
| 2 | Dual Reagent Tray   |   |                                                                                                                                |

### See also:

- [1.10 Reagent Trays](#)
- [2.10.1 Prepare Reagent Container and Reagent Trays](#)
- [2.10.2 Load Reagent Trays](#)
- [2.10.6 Unload Reagent Trays](#)
- [4.9 Wipe down Reagent Platform and ARC Bank Surfaces](#)

# 1.7 Bulk Containers

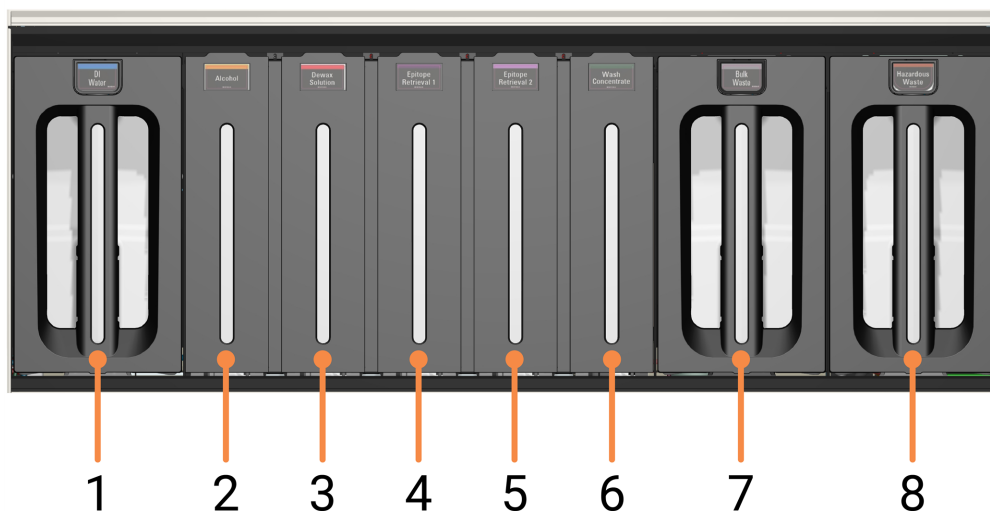

## Legend

1	DI Water	5	BOND-PRIME Epitope Retrieval 2
2	Alcohol	6	BOND-PRIME Wash Solution Concentrate
3	BOND-PRIME Dewax Solution	7	Bulk Waste
4	BOND-PRIME Epitope Retrieval 1	8	Hazardous Waste



**WARNING:** Use both hands when you lift the DI Water and Bulk/Hazardous Waste containers for cleaning and maintenance tasks.

## See also:

- [4.2 Refill the DI Water Container](#)
- [4.15 Clean the Bulk DI Water Container](#)
- [4.3 Refill the Alcohol Container](#)
- [4.16 Clean the Locked Bulk Reagent Containers](#)
- [4.4 Refill the Lot Tracked Bulk Containers](#)
- [4.17 Clean the Waste Containers](#)
- [4.5 Empty the Waste Containers](#)

## 1.8 Reservoir Cabinet

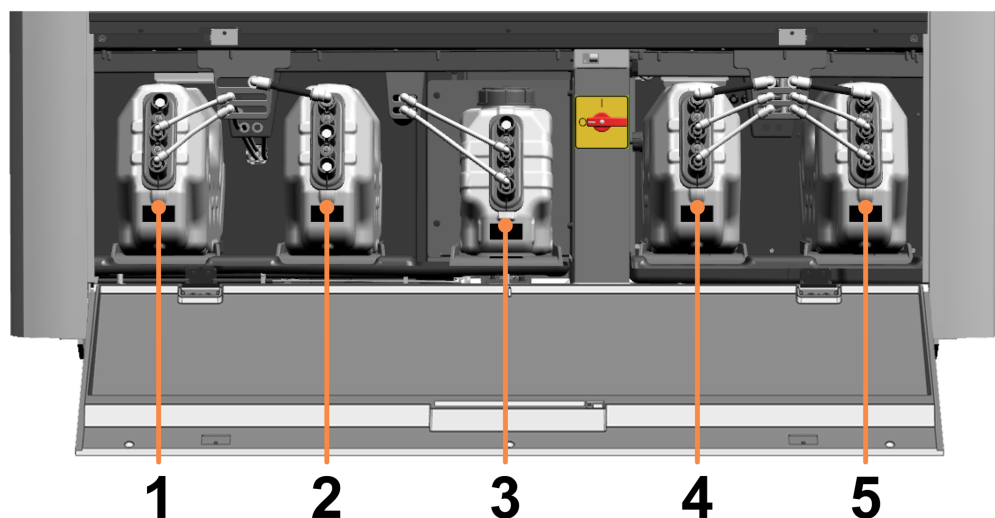

### Legend

1	DI Water Reservoir	5L
2	Vacuum Reservoir	
3	BOND-PRIME Wash Working Solution Reservoir	1L
4	Bulk Waste Reservoir	5L
5	Hazardous Waste Reservoir	5L



**WARNING:** Take care not to trip over the Reservoir Cabinet door when it is in the open position.

## 1.9 AC power switch

The AC power switch is located in the Reservoir Cabinet.

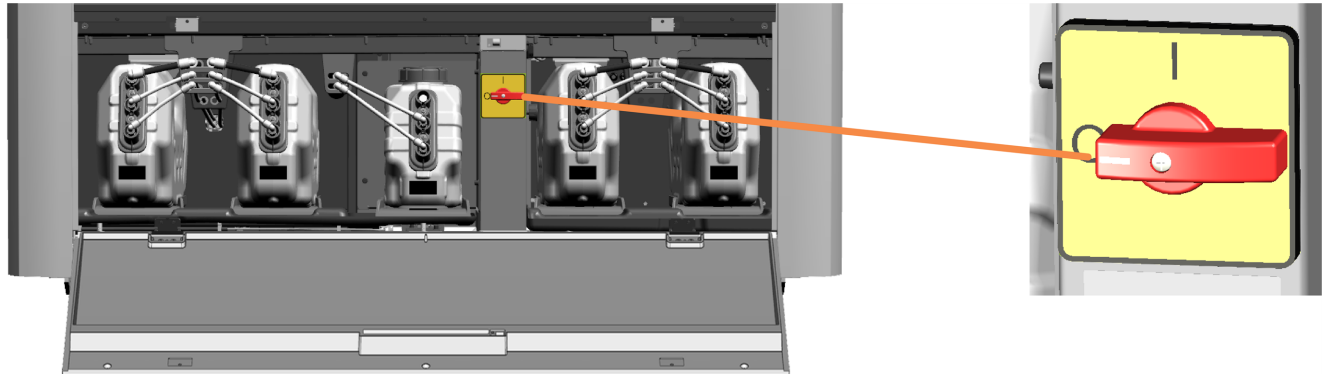

Switch positions:

- I ON
- O OFF



**WARNING:** Take care not to trip over the Reservoir Cabinet door when it is in the open position.

See also:

- [1.12 Connect the processing module and switch on](#)
- [1.13 Disconnect the processing module](#)

## 1.10 Reagent Trays

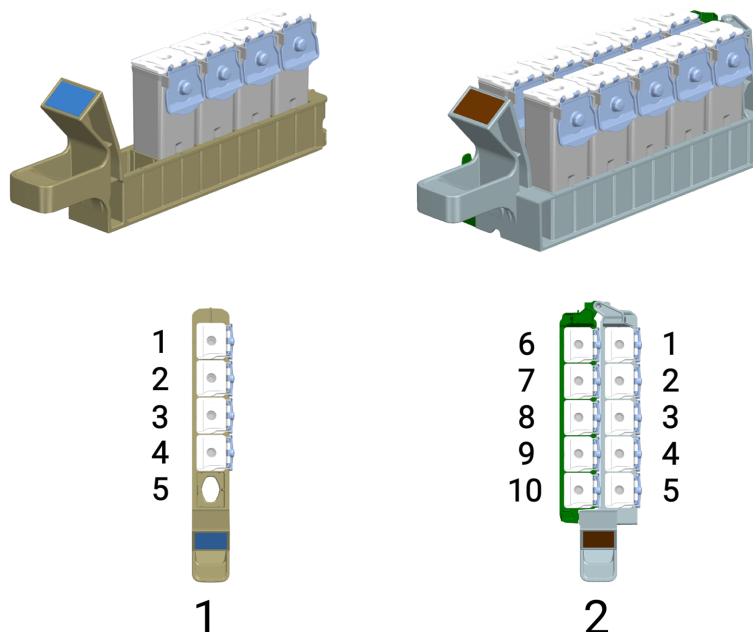

### Legend

- 1 **Single Reagent Tray**  
Can hold up to 5 reagent containers.
- 2 **Dual Reagent Tray**  
Can hold up to 10 reagent containers, although some reagent systems have only 6 containers. You can insert additional reagent containers, for example the ancillary BOND-PRIME Hematoxylin (AR0096), into empty locations.

All BOND reagent containers and BOND-PRIME reagent systems must be registered on the BOND Controller before use.

### See also:

- [1.6 Reagent Platform](#)
- [2.10.1 Prepare Reagent Container and Reagent Trays](#)
- [2.10.2 Load Reagent Trays](#)
- [2.10.6 Unload Reagent Trays](#)



Refer to the *BOND 7 User Manual*.

## 1.11 The Work Surface (under the Hood)

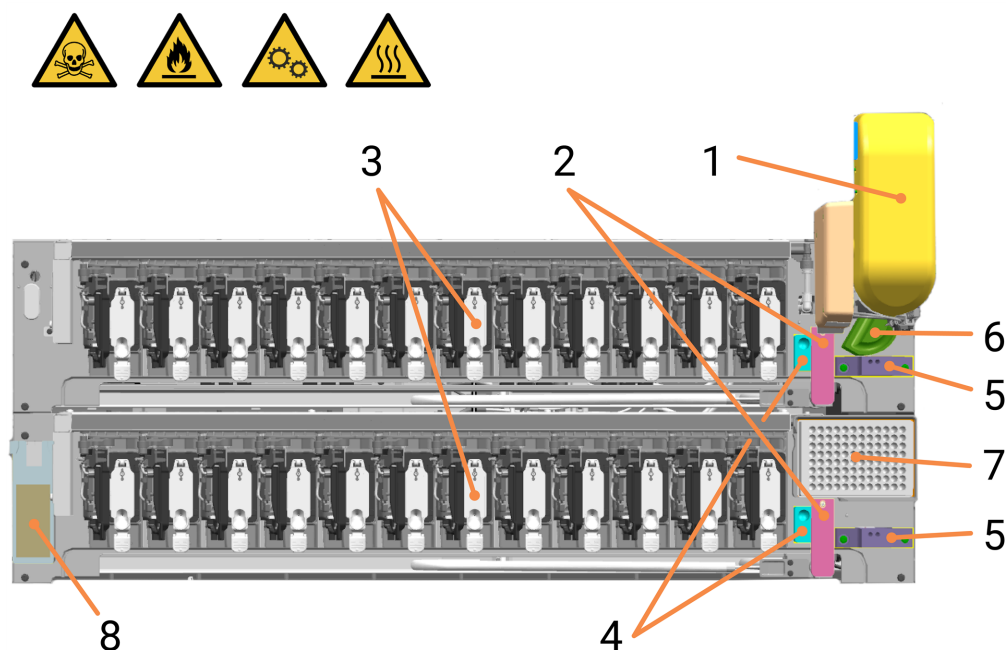

### Legend

- |                                                                                                                                                                                                                                                                                                                                                                                                                                |                                                                                                                                                                                                                                                                                                                                                                                                                                                 |
|--------------------------------------------------------------------------------------------------------------------------------------------------------------------------------------------------------------------------------------------------------------------------------------------------------------------------------------------------------------------------------------------------------------------------------|-------------------------------------------------------------------------------------------------------------------------------------------------------------------------------------------------------------------------------------------------------------------------------------------------------------------------------------------------------------------------------------------------------------------------------------------------|
| <p>1 <a href="#">1.11.2 High-Speed Robot</a></p> <p>2 <a href="#">1.11.4 Wash Robots</a> (2)</p> <p>3 <a href="#">1.11.5 ARC (Active Reagent Control) Modules</a></p> <ul style="list-style-type: none"> <li>• Bank A (rear) numbered 1-12 from left to right</li> <li>• Bank B (front) numbered 1-12 from left to right</li> </ul> <p>4 <a href="#">1.11.6 Wash/Prime Stations</a></p> <p>Wash Stations (for Wash Robots)</p> | <p>5 <a href="#">1.11.6 Wash/Prime Stations</a></p> <p>For the ARC Probe on the High-Speed Robot:</p> <ul style="list-style-type: none"> <li>• Standard Wash Station (rear)</li> <li>• Hazardous Wash Station (front)</li> </ul> <p>6 <a href="#">1.11.6 Wash/Prime Stations</a></p> <p>Prime Station (for Bulk Reagent Probes)</p> <p>7 <a href="#">1.11.7 Mixing Well Plate</a></p> <p>8 <a href="#">1.11.8 Slide Preparation Station</a></p> |
|--------------------------------------------------------------------------------------------------------------------------------------------------------------------------------------------------------------------------------------------------------------------------------------------------------------------------------------------------------------------------------------------------------------------------------|-------------------------------------------------------------------------------------------------------------------------------------------------------------------------------------------------------------------------------------------------------------------------------------------------------------------------------------------------------------------------------------------------------------------------------------------------|

### See also:

- [4.14 Use the BOND-PRIME ARC Refresh Kit](#)
- [4.7 Start Maintenance](#)
- [5.3.3 Manually retrieve slides from ARC Modules](#)
- [4.8 Wipe internal surface of ARC Modules](#)
- [4.9 Wipe down Reagent Platform and ARC Bank Surfaces](#)
- [4.13 Clean the Wash/Prime Stations](#)



## 1.11.1 Work Surface (front view)

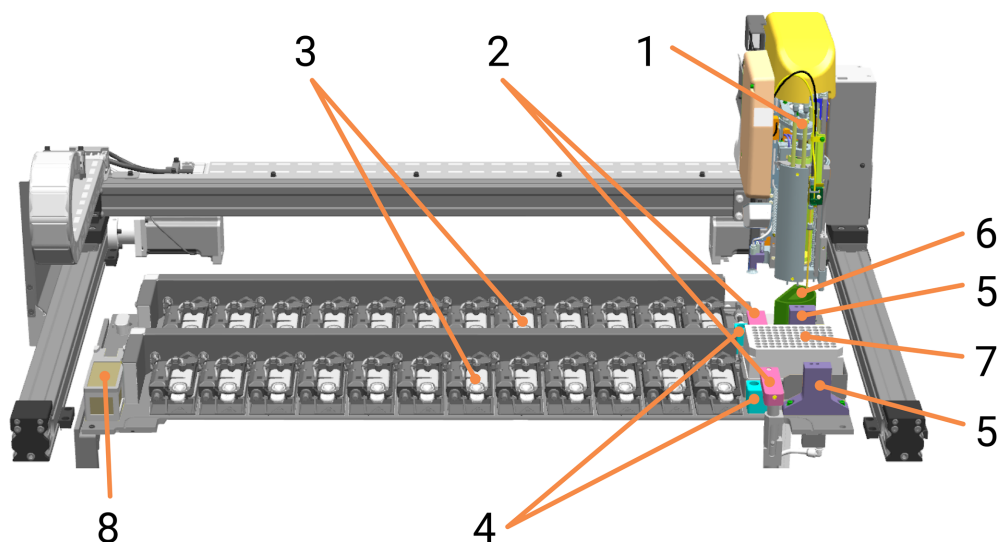

### Legend

- |                                                                                                     |                                             |                                                                                                          |                                  |
|-----------------------------------------------------------------------------------------------------|---------------------------------------------|----------------------------------------------------------------------------------------------------------|----------------------------------|
| 1                                                                                                   | 1.11.2 High-Speed Robot                     | 5                                                                                                        | 1.11.6 Wash/Prime Stations       |
| 2                                                                                                   | 1.11.4 Wash Robots (2)                      | For ARC Probe on High-Speed Robot:<br>Standard Wash Station (rear) and<br>Hazardous Wash Station (front) |                                  |
| 3                                                                                                   | 1.11.5 ARC (Active Reagent Control) Modules | 6                                                                                                        | 1.11.6 Wash/Prime Stations       |
| Bank A (rear) numbered 1-12 from left to right.<br>Bank B (front) numbered 13-24 from left to right |                                             | Prime Station (for Bulk Reagent Probes)                                                                  |                                  |
| 4                                                                                                   | 1.11.6 Wash/Prime Stations                  | 7                                                                                                        | 1.11.7 Mixing Well Plate         |
| Wash Stations (for Wash Robots)                                                                     |                                             | 8                                                                                                        | 1.11.8 Slide Preparation Station |

## 1.11.2 High-Speed Robot

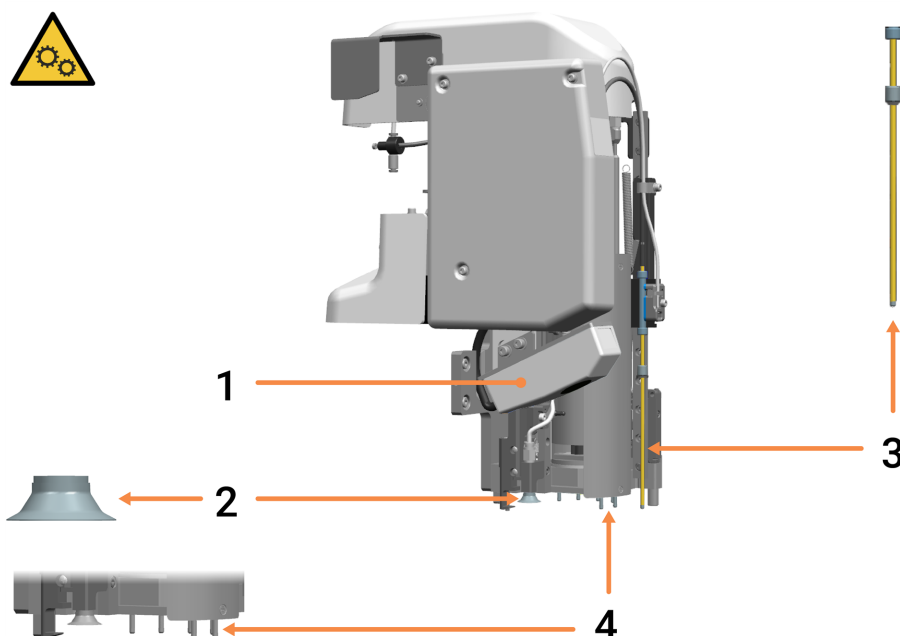

### Legend

- |                                                                                                                                                                                                                                                                    |                                                                                                                                                                                                                                                                                                                                                                                                                                                                                                                                    |
|--------------------------------------------------------------------------------------------------------------------------------------------------------------------------------------------------------------------------------------------------------------------|------------------------------------------------------------------------------------------------------------------------------------------------------------------------------------------------------------------------------------------------------------------------------------------------------------------------------------------------------------------------------------------------------------------------------------------------------------------------------------------------------------------------------------|
| <p><b>1 ID Imager</b></p> <p><b>2 Suction Cup</b><br/>For moving slides from Preload Drawer to ARC Modules to Unload Drawer.<br/><br/>Refer to <a href="#">1.4 Preload and Unload Drawers</a> and <a href="#">1.11.5 ARC (Active Reagent Control) Modules</a>.</p> | <p><b>3 ARC Probe</b><br/>Dispenses reagents obtained from reagent to ARC Modules from:</p> <ul style="list-style-type: none"> <li>• containers loaded on Reagent Platform. Refer to <a href="#">1.6 Reagent Platform</a>.</li> <li>• mixed reagents obtained from Mixing Well Plate. Refer to <a href="#">1.11.7 Mixing Well Plate</a>.</li> </ul> <p><b>4 Bulk Reagent Probes (also see next page)</b><br/>Dispense bulk reagents from bulk reagent containers to ARC Modules. Refer to <a href="#">1.7 Bulk Containers</a>.</p> |
|--------------------------------------------------------------------------------------------------------------------------------------------------------------------------------------------------------------------------------------------------------------------|------------------------------------------------------------------------------------------------------------------------------------------------------------------------------------------------------------------------------------------------------------------------------------------------------------------------------------------------------------------------------------------------------------------------------------------------------------------------------------------------------------------------------------|



**WARNING:** If the High-Speed Robot gets stuck in a position above the Work Surface, do not attempt to manually move it. Contact customer support about the problem.

### See also:

- [4.10 Clean the Suction Cup](#)
- [4.11 Replace the Suction Cup](#)

## 1.11.3 Probe Selector

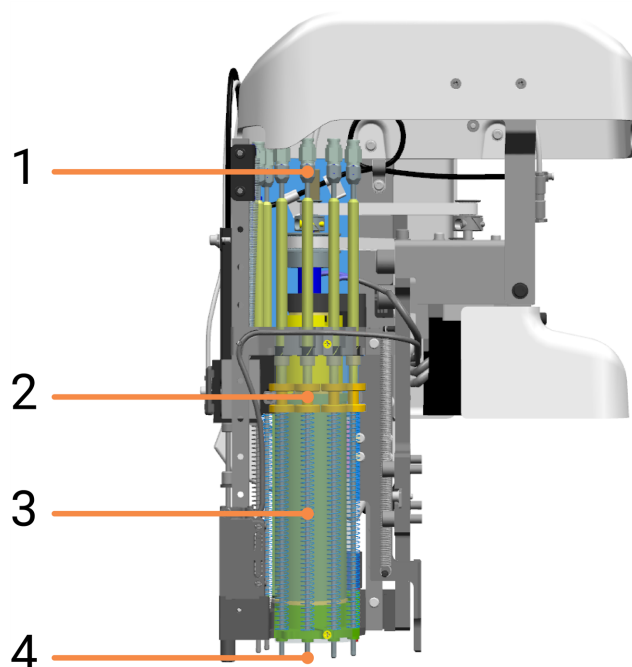

### Legend

1 Tubing connectors

2 Bulk Reagent Probe Ferrules

3 Compression Springs

4 Bulk Reagent Probes

The Bulk Reagent Probes are attached to the Probe Selector on the Robot Head. The Probe Selector carousel rotates to position the required probe above an ARC Module.

## 1.11.4 Wash Robots

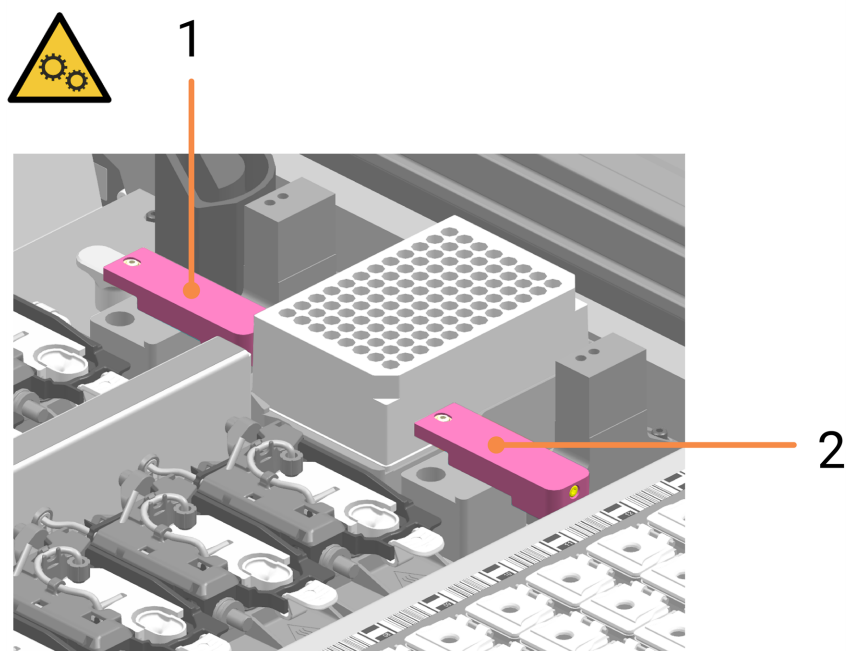

### Legend

- 
- 1 Wash Robot (for ARC Modules - Bank A)
  - 2 Wash Robot (for ARC Modules - Bank B)
- 

## Wash Robot Probe

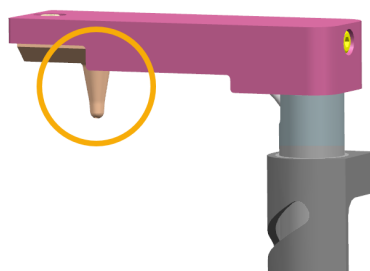

During maintenance, you can manually move the Wash Robots to gain better access to the ARC Modules.

If a Wash Robot gets stuck in a position above the Work Surface, do not attempt to manually move it anymore. Contact customer support about the problem

## 1.11.5 ARC (Active Reagent Control) Modules

Twenty-four ARC Modules mounted on two ARC Banks hold slides during staining. Collectively, they are known as the ARC Array. Reagents are dispensed by the Bulk Reagent Probes and the ARC Probe on the Robot Head. ARC Modules are cleaned using DI Water and BOND-PRIME Wash Working Solution dispensed by the Wash Robots.

Waste from the ARC Modules is directed to the Hazardous Waste Reservoir.

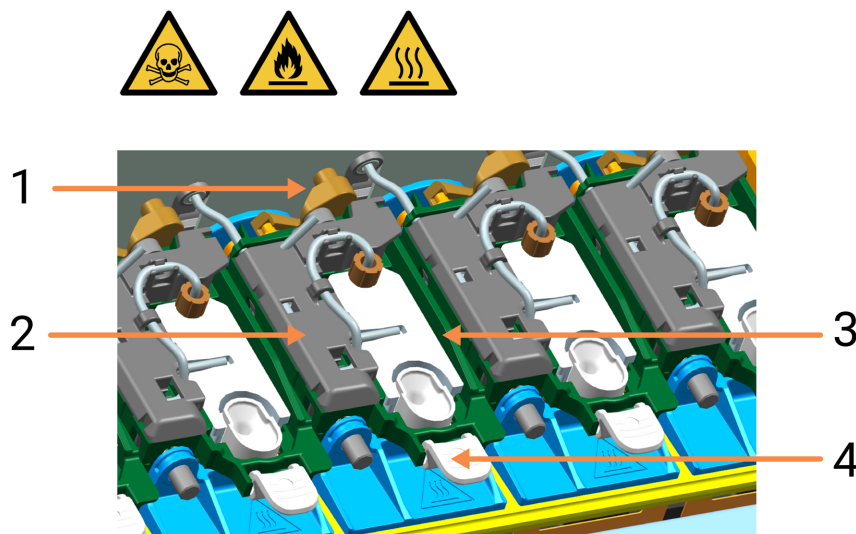

### Legend

- |   |                  |   |                         |
|---|------------------|---|-------------------------|
| 1 | ARC Module Latch | 3 | ARC Module Lid Assembly |
| 2 | ARC Module Cover | 4 | ARC Covertile:          |



If the Action Queue (see [Action Queue and Alert Banner \(on page 68\)](#)) indicates that an ARC Module is faulty, check that it has a Covertile.

If an ARC Module is leaking, check the:

- condition of the Covertile and Covertile seal, and if necessary, replace the Covertile.
- ARC Module for debris, and if necessary, clean ([Wipe internal surface of ARC Modules \(on page 126\)](#)).

### See also:

- [4.8 Wipe internal surface of ARC Modules](#)
- [4.14 Use the BOND-PRIME ARC Refresh Kit](#)
- [5.3.3 Manually retrieve slides from ARC Modules](#)

## 1.11.6 Wash/Prime Stations

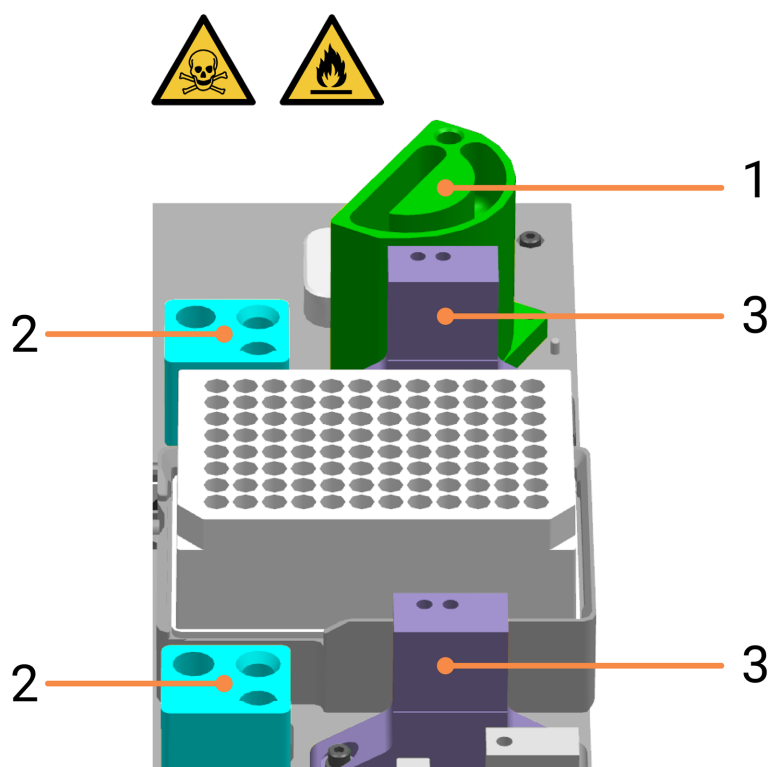

### Legend

- |                                                                        |                                                                       |
|------------------------------------------------------------------------|-----------------------------------------------------------------------|
| 1 Bulk Probe Prime Station                                             | 3 ARC Probe Wash Stations<br>The right-hand port is used for washing. |
| 2 Wash Robot Wash Stations<br>The right-hand port is used for washing. |                                                                       |

Waste liquid from:

- the ARC Probe Wash Station on Bank A (rear) is directed to the Bulk Waste Reservoir
- the ARC Probe Wash Station on Bank B (front) is directed to the Hazardous Waste Reservoir
- both Wash Robot Wash Stations is directed to the Hazardous Waste Reservoir.

See also:

- [4.13 Clean the Wash/Prime Stations](#)

## 1.11.7 Mixing Well Plate

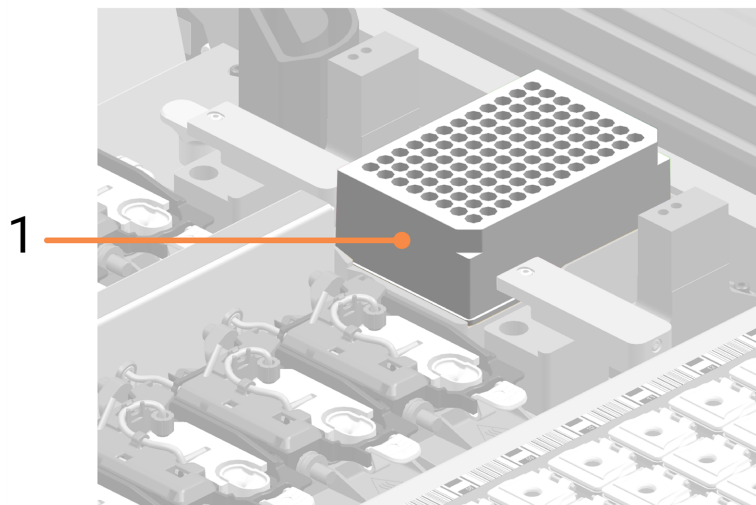

### Legend

#### 1 Mixing Well Plate

This is where chromogen reagents are mixed before being dispensed onto slides in the ARC Modules by the ARC Probe.

Refer to [1.11.5 ARC \(Active Reagent Control\) Modules](#) and [1.11.2 High-Speed Robot](#).

The orientation of the Mixing Well Plate on the Mixing Block is not important, however it must be seated correctly within the holder.



The processing module will not complete initialization if there is no Mixing Well Plate installed.

### See also:

- [4.14 Use the BOND-PRIME ARC Refresh Kit](#)

## 1.11.8 Slide Preparation Station

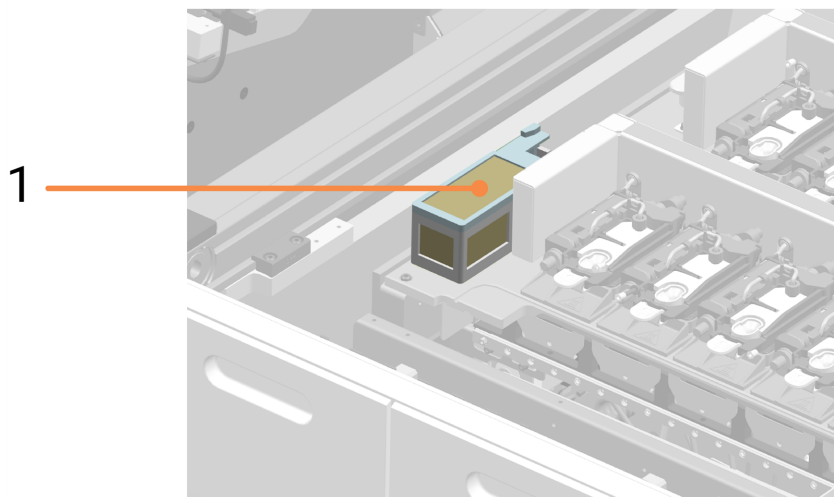

### Legend

1 Slide Preparation Station



Before each slide is transferred to an ARC Module for processing, it is cleaned using compressed air jets in the Slide Preparation Station. This is designed to remove unwanted particles, particularly glass particles, from the slide surfaces so that the staining process is not compromised.



## 1.12 Connect the processing module and switch on

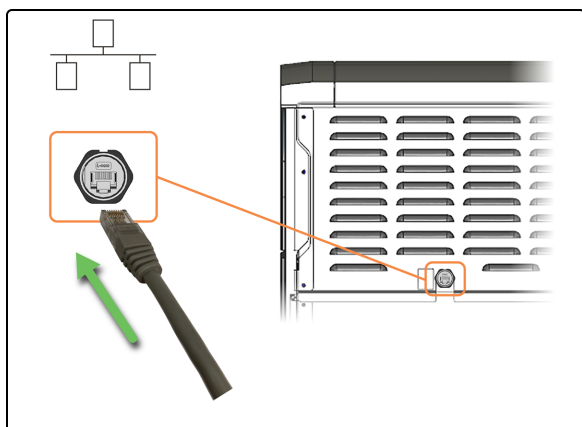

1. Plug in the Ethernet cable to the laboratory network port.



You may need to move the processing module for better access to the rear-panel connectors.

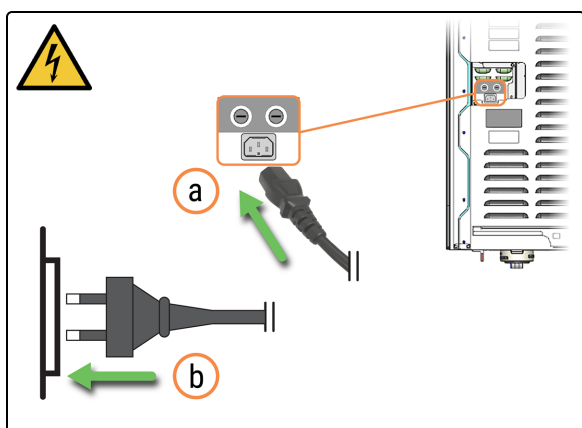

2. Plug in the mains power cable.
  - a. Plug the mains power cable into the rear of the processing module.
  - b. Plug the mains power cable into the wall socket.



You may need to move the processing module for better access to the rear-panel connectors.

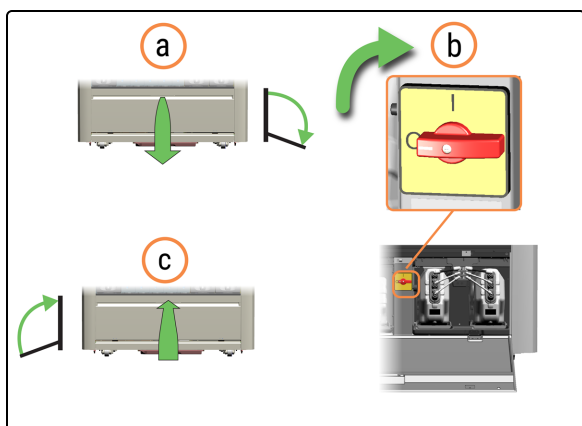

3. Power on the processing module.
  - a. Open the Reservoir Cabinet door.
  - b. Turn the AC power switch clockwise.
  - c. Close the Reservoir Cabinet door.



4. When the processing module is turned on, it initializes before displaying the Log In Screen. This process takes from 8 to 15 minutes. If the processing module fails to initialize, refer to [5.1 Failure to initialize](#).

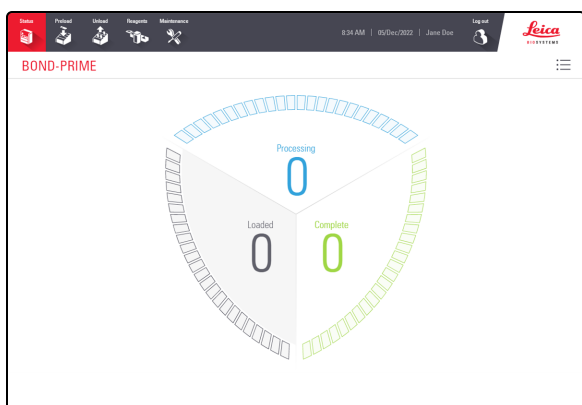

The Status screen is displayed.

## 1.13 Disconnect the processing module

You must shut down and disconnect the processing module:

- before moving the processing module to a new location
- before decommissioning the processing module



Before you start this procedure, ensure you are logged in to the processing module. Refer to [2.1 Log in and log out](#).



1. Tap **Status**.

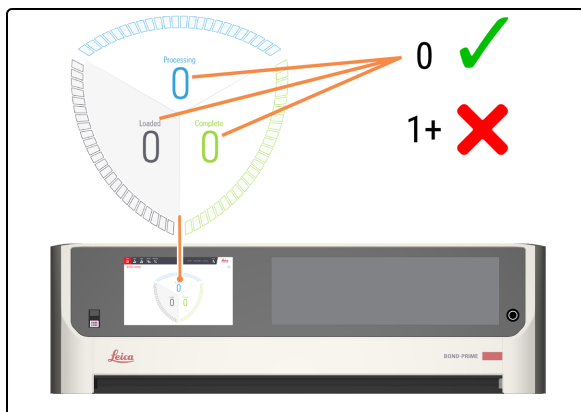

2. Check the Status screen to ensure there are:

- no slides currently being processed (Processing)
- no slides in the Preload Drawer (Loaded) and Unload Drawer (Complete).

Refer to [2.3 Status Screen](#).

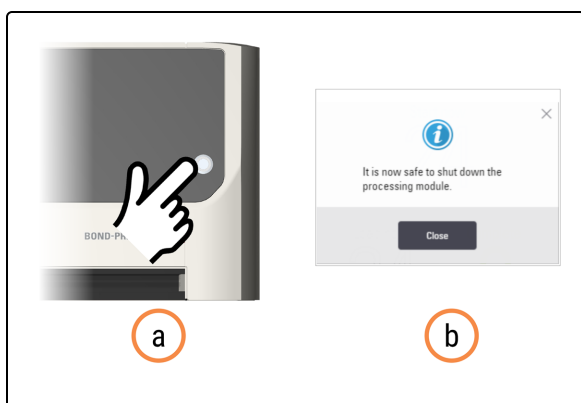

3. Power down the processing module.

a. Press the standby power button.

A pop up window indicates that it is safe to shut down the processing module.

b. Tap **Close**.

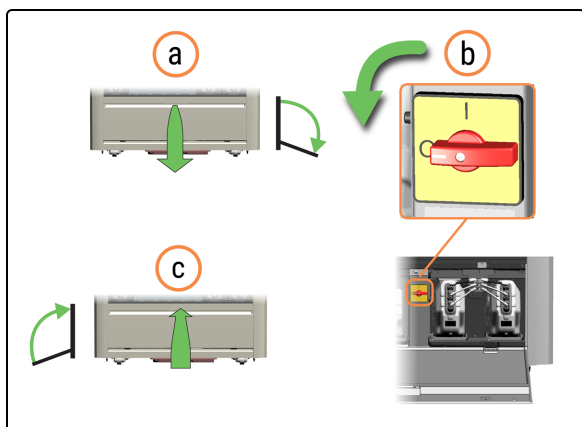

4. Power off the processing module.
  - a. Open the Reservoir Cabinet door.
  - b. Turn the AC power switch counterclockwise.
  - c. Close the Reservoir Cabinet door.



**WARNING:** Take care not to trip over the Reservoir Cabinet door when it is in the open position.

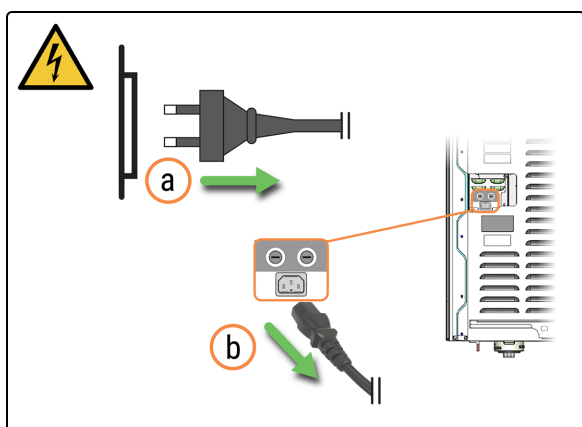

5. Unplug the mains power cable.
  - a. Unplug the mains power cable from the wall socket.
  - b. Unplug the mains power cable from the rear of the processing module.



You may need to move the processing module for better access to the rear-panel connectors.

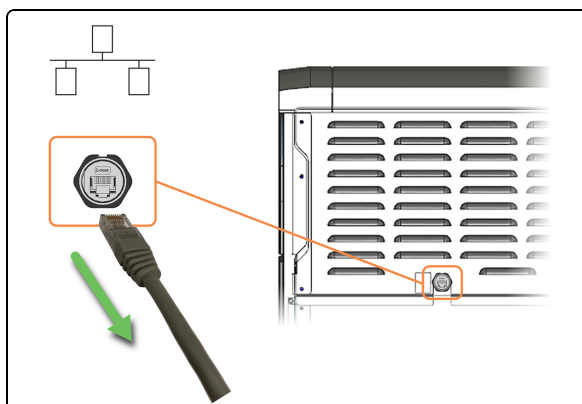

6. Disconnect Ethernet cable from rear of of the processing module.

## 1.14 Move a processing module to a new location



**WARNING:** If you need to move a processing module a long distance to a new location, notify customer support. The processing module is very heavy. Only approved personnel should move the processing module.



**CAUTION:** Do not seal the ventilation openings on the rear cover of the processing module. Make sure there is sufficient airflow at the new location.



**CAUTION:** Do not use a forklift to lift a BOND-PRIME Processing Module.

If it is necessary to move a processing module only a short distance to a new location:

- Disconnect the processing module. Refer to [1.13 Disconnect the processing module](#).
- Empty the waste containers. Refer to [4.5 Empty the Waste Containers](#).
- Remove and clean the Sump Tray. Refer to [4.18 Clean the Sump Tray](#).
- Before you attempt to move a BOND-PRIME Processing Module, use a spanner to rotate the orange gears on the four wheel assemblies. Raise the central feet to allow the processing module to move freely on its wheels.



- Push **only** on the allowable push zones, shown highlighted in orange.

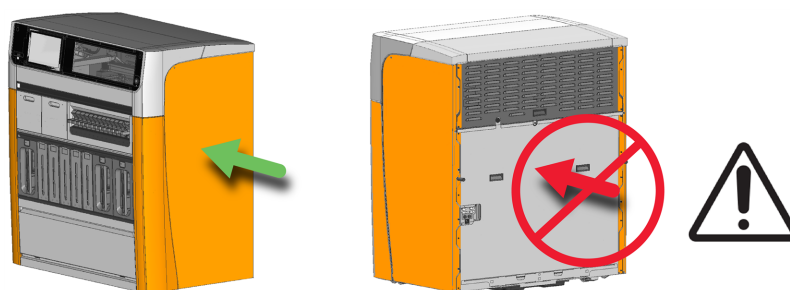

- At the new location, which should have a level surface, rotate the orange gears to lower the central feet until the processing module cannot move freely on its wheels.
- Adjust the height of the feet in the wheel assemblies to make sure that the processing module is level in all directions. Use a spirit level on top of the hood as a guide.
- Make sure that the floor has sufficient strength. Obey all local and relevant procedures. To find the dimensions and weight of the processing module, refer to [6 Specifications](#).
- Use only the approved power supply cable. Make sure that you can get access to the wall socket.
- Evaluate the electromagnetic environment prior to operation of the processing module for interference.



**CAUTION:** Do not operate a BOND-PRIME Processing Module near sources of strong electromagnetic radiation. For example unshielded intentional RF sources, which may interfere with proper operation.

## 1.15 Decommission and dispose of a processing module

The processing module, including parts and associated accessories used, must be disposed of according to applicable local procedures and regulations. Dispose of any reagents used with the processing module in accordance with the recommendations of the reagent manufacturer.

Clean and decontaminate in accordance with local procedures and regulations before returning or disposing of the processing module or parts and accessories.

In the EU, all electronic waste must be disposed of in accordance with Waste Electrical and Electronic Equipment (2012/19/EU). In regions outside of the EU, follow local procedures and regulations for the disposal of electronic waste.

If you need assistance, contact your local Leica Biosystems representative.

# 2

# Touchscreen

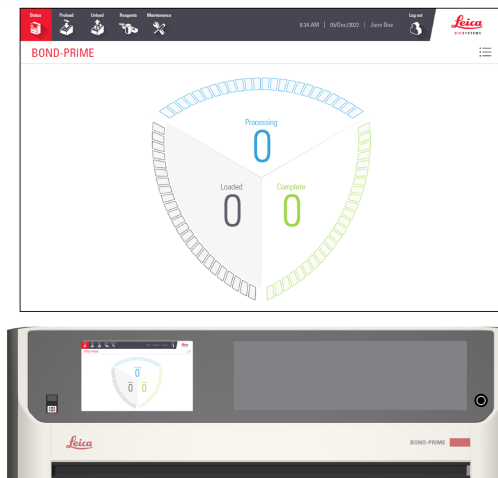

In this section:

2.1 Log in and log out .....	57
2.2 Navigation Bar .....	59
2.3 Status Screen .....	60
2.4 Action Queue and Alert Banner .....	68
2.5 Preload slides .....	71
2.6 Preload Screen .....	73
2.7 Unload slides .....	78
2.8 Unload Screen .....	80
2.9 Detailed case and slide information .....	84
2.10 Reagents Screen .....	88
2.11 Maintenance Screen .....	95



## 2.1 Log in and log out

### 2.1.1 Log in

If nobody is logged in, various actions will cause the **Log in** dialog to appear, for example:

- tapping the **Log in** button
- tapping the **Start maintenance** button on the **Maintenance** screen
- scanning the barcode on a bulk reagent supply bottle
- loading a Reagent Tray onto the Reagent Platform

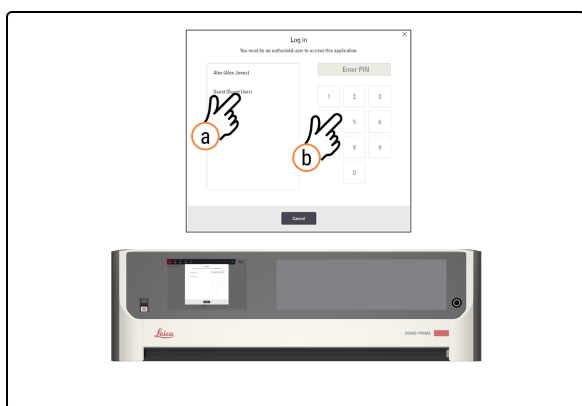
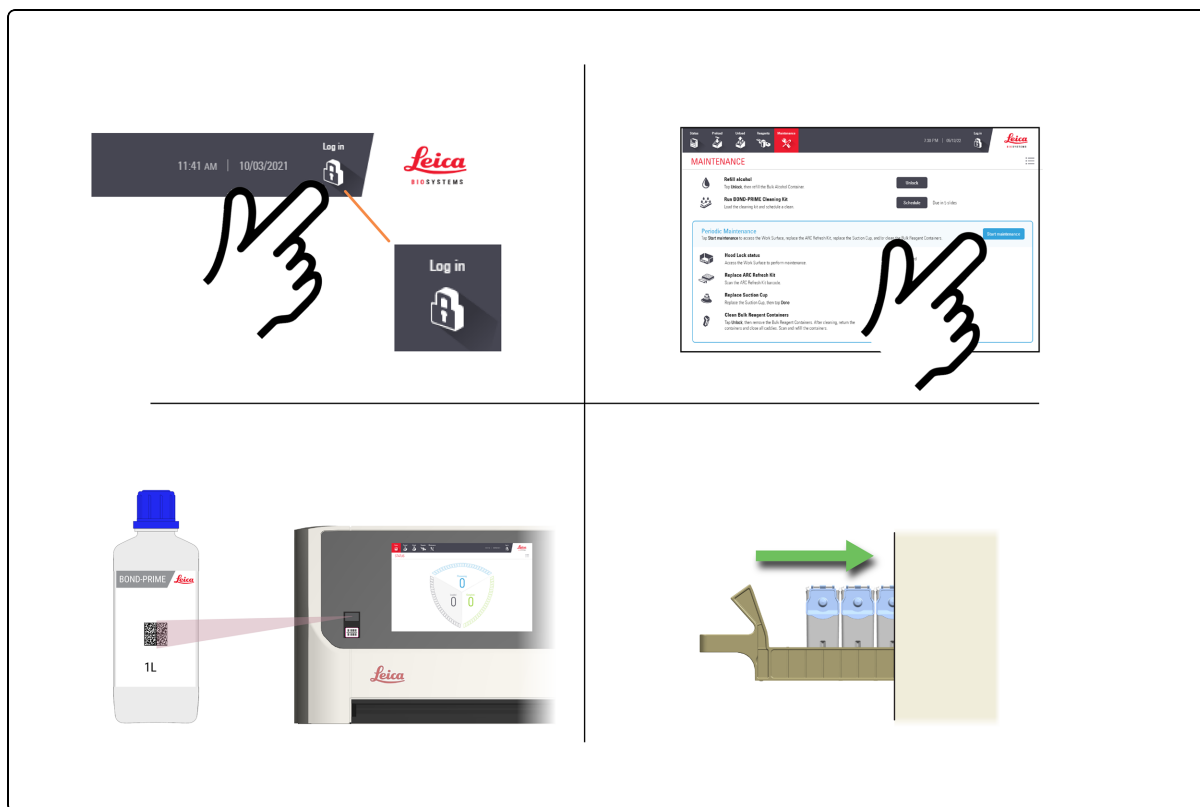

1. Log in to the touchscreen.
  - a. On the **Log in** Screen, tap your user name.
  - b. Enter your PIN.

When you have logged in successfully, your name is displayed next to the date.

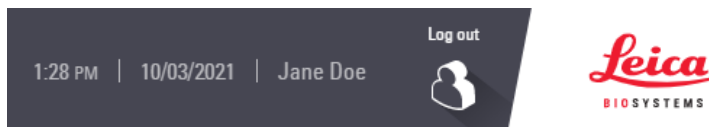

Refer to the *BOND 7 User Manual* for information about setting or changing your PIN.



Patient Health Information is visible on the GUI when logged in, and hidden when logged out.

## 2.1.2 Log out

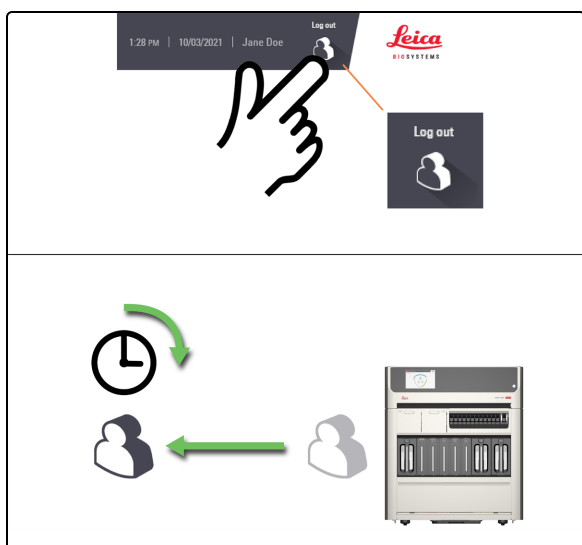

1. Tap the **Log out** button.

Or, if you do not interact with the processing module for a pre-determined time period, you will be logged out automatically.



You can change this time period in the Administration Client on the BOND Controller. Refer to the *BOND 7 User Manual*.

## 2.2 Navigation Bar

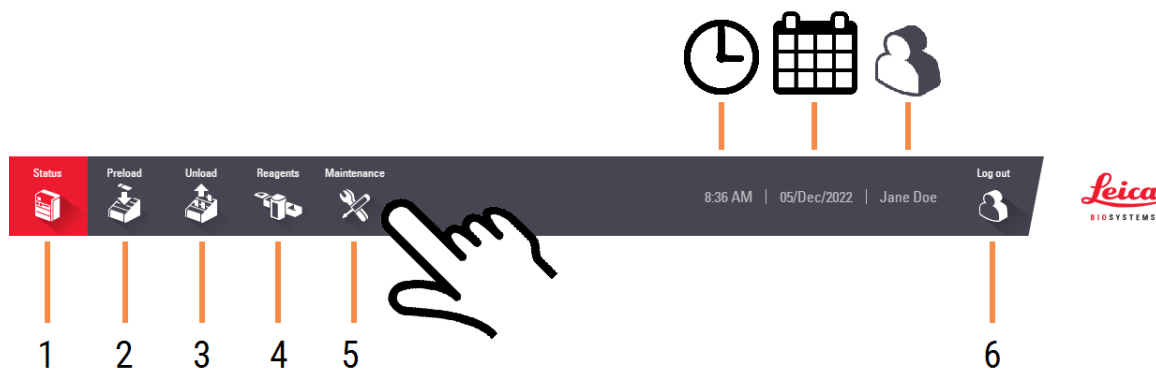

### Legend

1	2.3 Status Screen	4	2.10 Reagents Screen
2	2.6 Preload Screen	5	2.11 Maintenance Screen
3	2.8 Unload Screen	6	Log in / Log out - refer to 2.1 Log in and log out

## 2.3 Status Screen

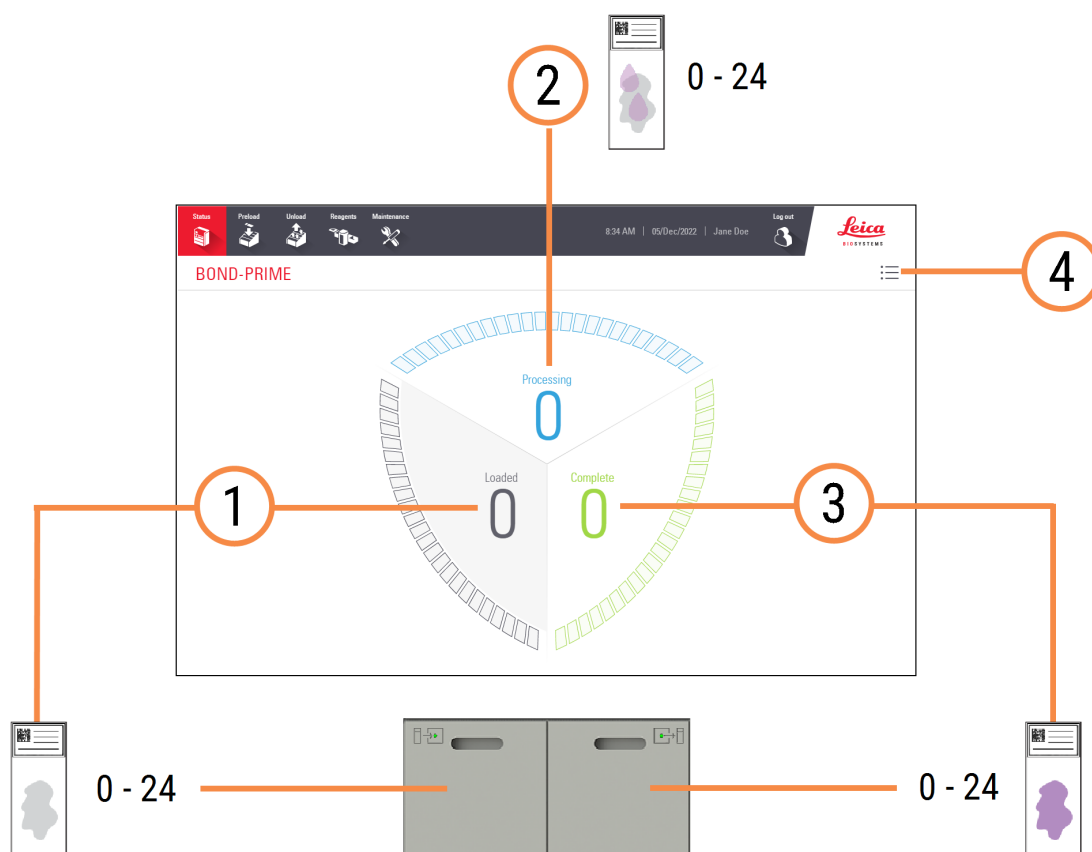

### Legend

- 1 2.3.1 Slides Loaded Segment
- 2 2.3.2 Slides Processing Segment
- 3 2.3.3 Slides Processing Complete Segment
- 4 **Action Queue button.**  
Refer to [2.4 Action Queue and Alert Banner](#)

### 2.3.1 Slides Loaded Segment

To alternately show the **Loaded** and **Load now** slide count, tap the displayed value.

After new slides are loaded into the Preload Drawer, they initially appear at the bottom of the segment and are grey. When slides are accepted, they move to the top of the segment and change to blue, earliest first. Slides that are not accepted remain at the bottom of the segment.



There is no relationship between slide positions in the Slides Loaded Segment and in the Preload Drawer.

Also refer to [2.3.4 View more slide information](#)

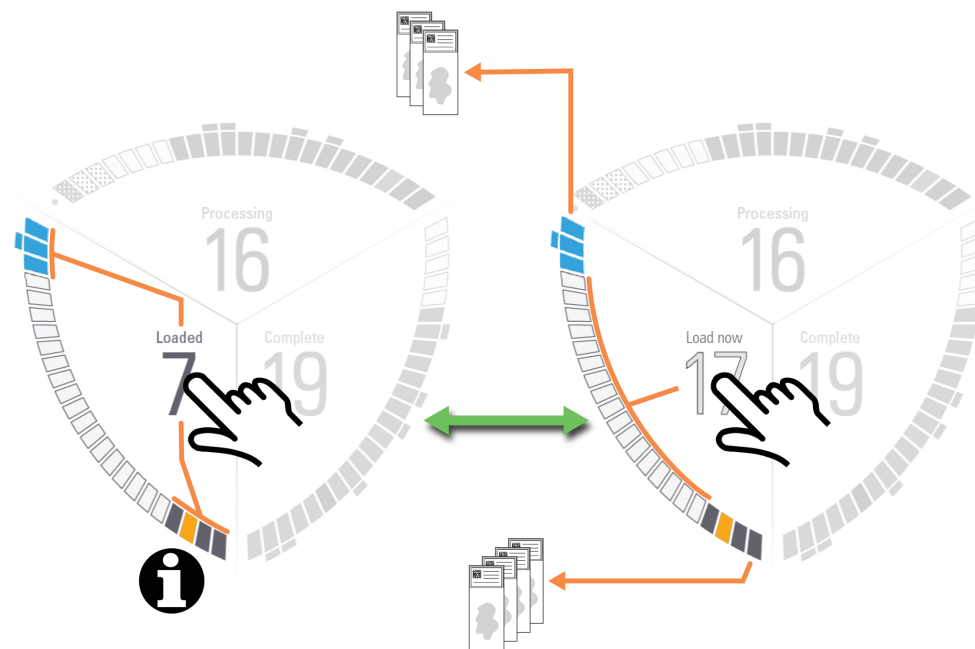

Icon	Description
	Slide position available.
	Slide identified.
	Last slide (of the loaded slides) in a case. When the last slide is accepted, this icon changes to blue.
	Slide accepted. Slides not accepted remain at the bottom of the segment. Also refer to <a href="#">2.3.1.1 Slides not accepted</a> .
	Rejected time-critical slide, or a slide with status "Warning".
	Rejected slide, or a slide with status "Caution".

### 2.3.1.1 Slides not accepted

On rare occasions, the processing module may fail to evaluate and accept a loaded slide.



When this happens, the slide remains at the bottom of the segment for an extended period.

To rectify this situation, you should:

- 1 Remove the slide from the Preload Drawer, then close the drawer.
- 2 Wait for the processing module to scan the drawer and update the Status screen.
- 3 Reload the slide into the Preload Drawer. The processing module should now be able to identify the slide and accept it for processing.

## 2.3.2 Slides Processing Segment

To alternately show the **Processing** and **Start now** slide count, tap the displayed value.

When slides are transferred to the ARC Modules for processing, they appear at the right of the segment, earliest first.

There is no relationship between slide positions in the Slides Processing Segment and in the ARC Modules.

Also refer to [2.3.4 View more slide information](#).

## Status Screen updates

The processing module may not always prioritize loading slides. This is because the processing module automatically performs a basic clean of each ARC Module in between processing slides.

The basic cleaning process helps to ensure that the staining quality is maintained at a high level for every slide processed.

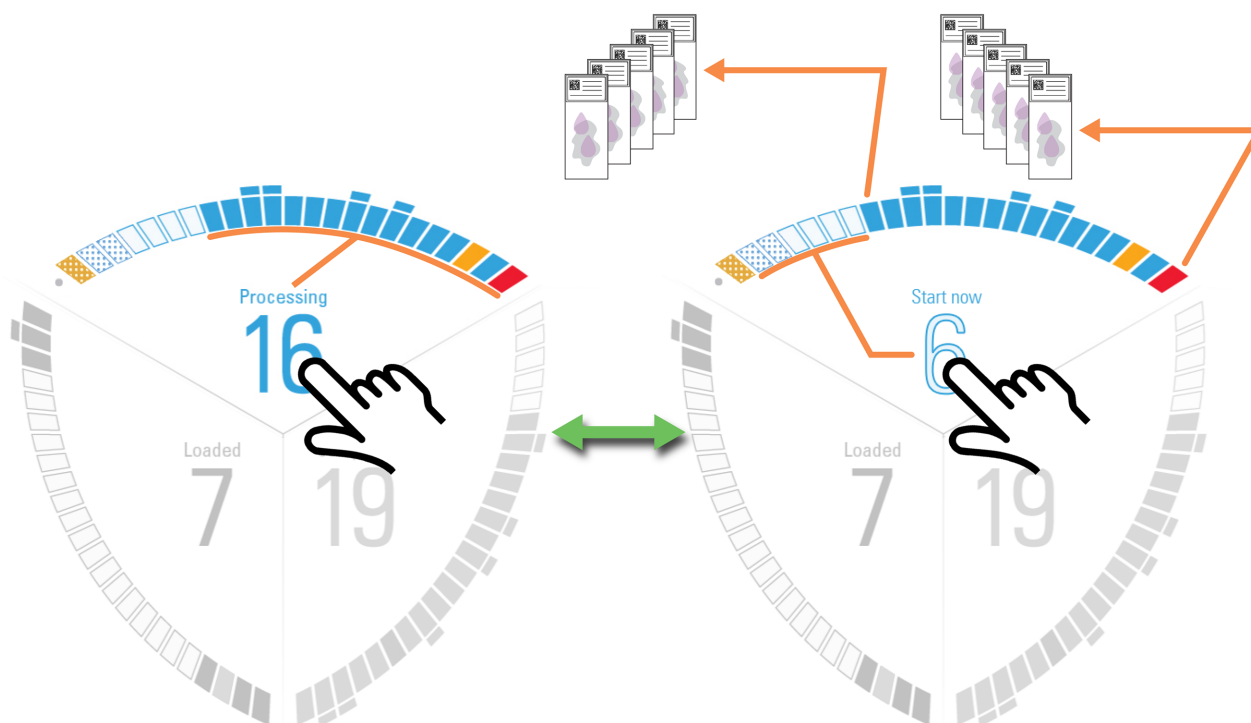

Icon	Description
	Slide position available
	A slide with status "Caution". Refer to <a href="#">2.3.5 Unexpected events during processing</a> .
	Last slide in a case
	Slide processing in progress
	Slide completed
	Faulty or disabled ARC Module. Refer to <a href="#">1.11.5 ARC (Active Reagent Control) Modules</a>
	The BOND-PRIME Cleaning kit is currently being applied, or a basic clean is being run between slides.
	ARC Module usage count has been reached. The ARC Module is disabled until the BOND-PRIME Cleaning kit is applied.
	Abandoned or canceled slide, or a slide with status "Warning". Abandoned slides remain in the ARC Module and need to be manually retrieved. Refer to <a href="#">5.3.3 Manually retrieve slides from ARC Modules</a> . Canceled slides are transferred to the Unload Drawer.

## 2.3.3 Slides Processing Complete Segment

When completed slides are transferred from the ARC Modules to the Unload Drawer, they appear at the bottom of the segment, earliest first.

If the Unload Drawer is full, "slide completed" icons appear in the Slides Processing Segment until they can be transferred to the Slides Processing Complete Segment.



There is no relationship between slide positions in the Slides Processing Complete Segment and in the Unload Drawer.

Also refer to [2.3.4 View more slide information](#).

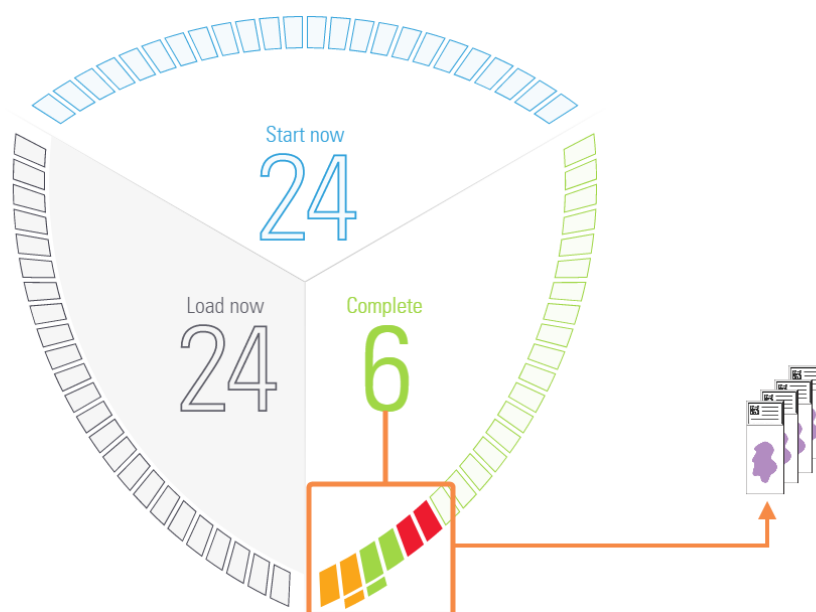

Icon	Description
	Slide position available
	Slide completed
	Last completed slide in a case
	Canceled slide or a slide with status "Warning"
	A slide with status "Caution" Also refer to <a href="#">2.3.5 Unexpected events during processing</a>



## 2.3.4 View more slide information

You must be logged in to view "protected" case and slide information.

Refer to [2.1 Log in and log out](#)

Tap on a slide in the segment to view related slide information. Tap on the presented slide image to open the case window and view related case information.

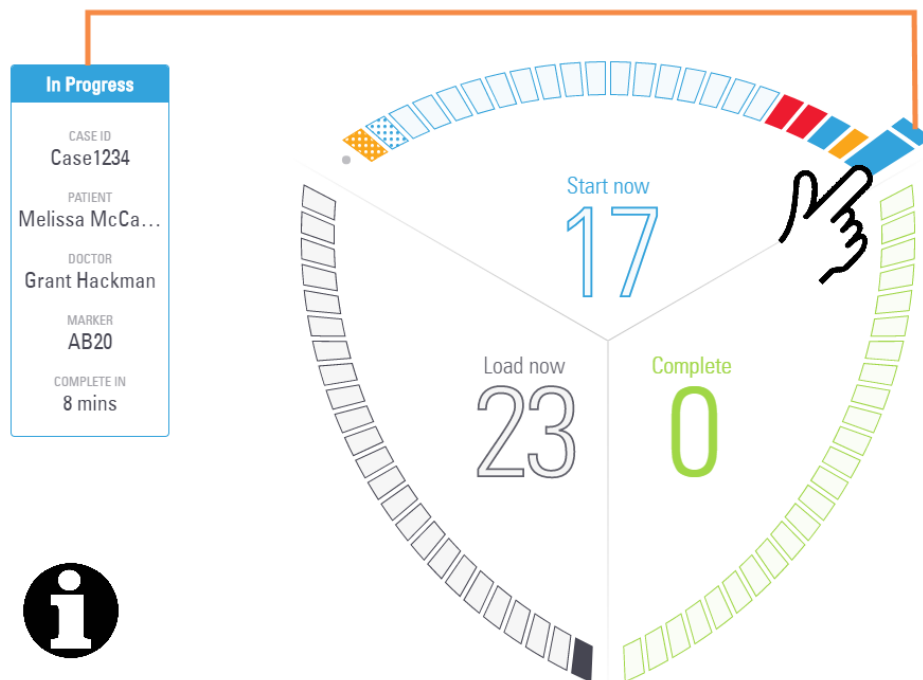

Drag your finger from slide-to-slide to continuously update the information shown.

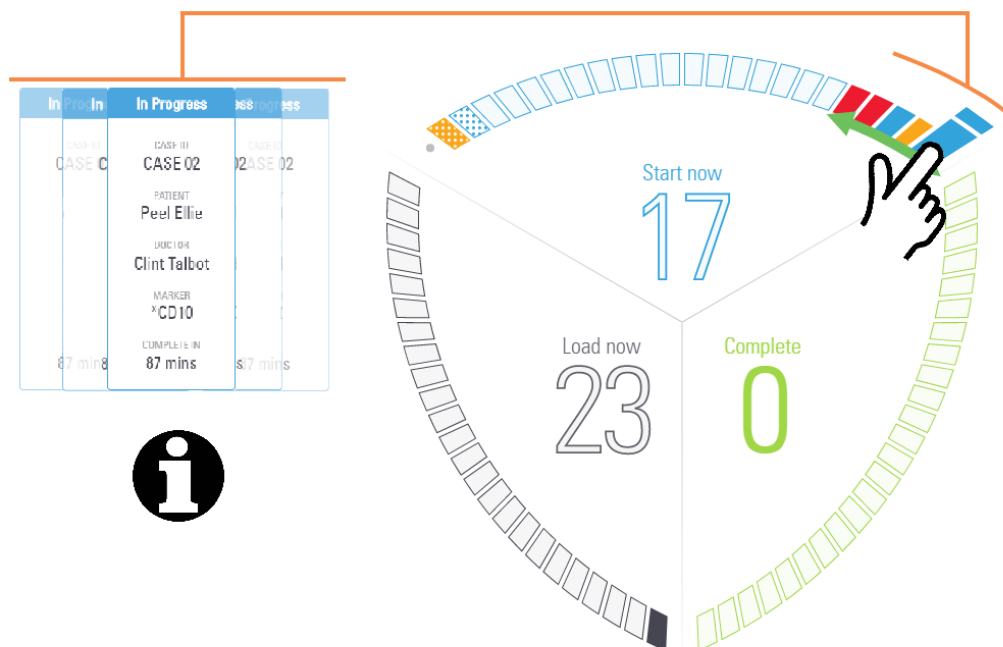

Also refer to [2.9 Detailed case and slide information](#) for additional information concerning slide properties, start/finish times and case properties.

## 2.3.5 Unexpected events during processing

If you see an Action Queue Item (AQI) regarding an unexpected event that occurred during processing, you must take extra steps to confirm that the flagged slide is suitable for diagnostic use.

This notification does not necessarily indicate that staining was in any way unsatisfactory, however the system operator or laboratory supervisor must:

- 1 Examine the **Slide history** screen on the BOND Controller (refer to the *BOND 7 User Manual*).
- 2 Look for a slide with the status **Done (events noted)** that has the same **Slide ID** as the flagged slide removed from the BOND-PRIME Processing Module.
- 3 Select this slide then click the **Run events** button to generate the Run Events Report.

Any events that caused a notification are displayed in **Bold** text. The system operator or laboratory supervisor should carefully consider the notification events listed, as these provide important details about the nature of the slide notification events.

- 4 Carefully inspect any control slides.
- 5 Carefully inspect the stained tissue.

If the laboratory is unable to confirm the staining quality, then either the pathologist should be informed of the notification or the test should be rerun. Multiple notifications may be present within a single Run Events Report. If the slide completes with status **Done (events noted)**, ensure that the entire report is inspected. If the status is **Done (OK)**, there is no need to inspect the report.

## 2.4 Action Queue and Alert Banner

### 2.4.1 Show and hide the Action Queue

The Action Queue is a list of important messages concerning the status of the processing module, reagents, and/or slides. These messages can provide information about the processing module or an instruction to perform a maintenance task.

When there is a new Action Queue Item (AQI), an Alert Banner is displayed across the bottom of the Touchscreen. You can hide the Alert Banner by clicking on the **X** (see [2.4.3 Manually hide the Alert Banner](#)).

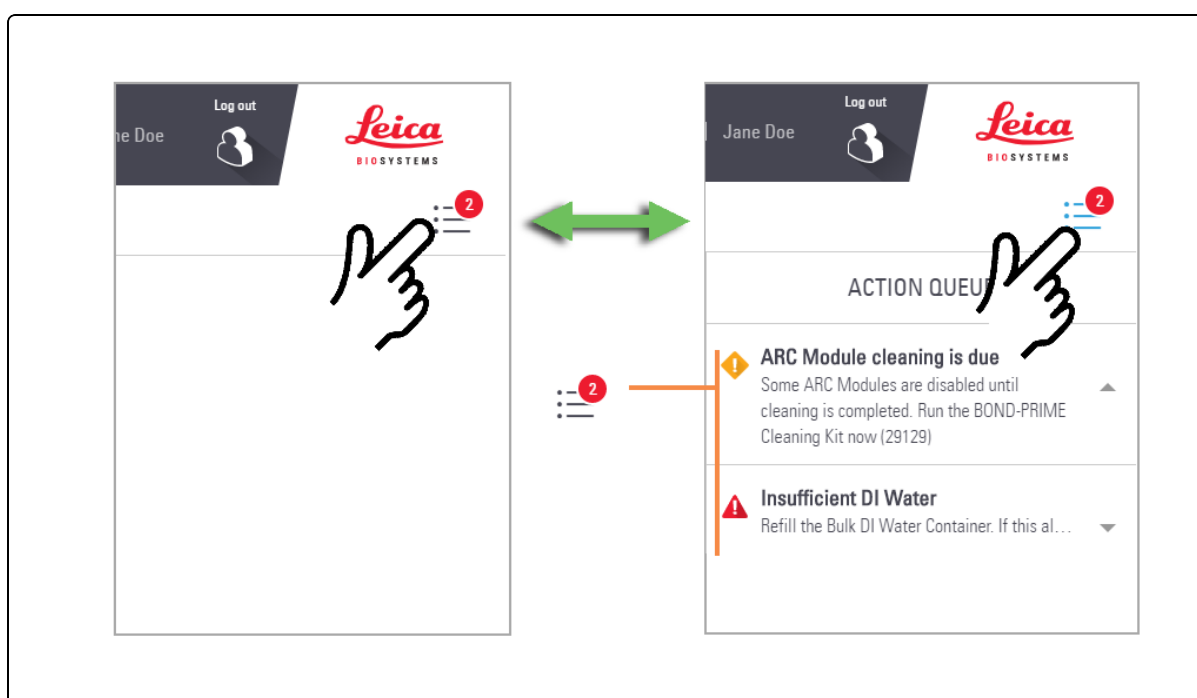

- 1 To show or hide the Action Queue, tap the Action Queue button.
- 2 To show more or less information about each item in the Action Queue, tap the arrow to the right of the item.

The level of importance of each Action Queue item is indicated by an icon:

	<b>Warning:</b> Take immediate action.
	<b>Caution:</b> Take action at your next opportunity.
	<b>Information:</b> For your awareness.

The number on the Action Queue button reflects the number of Warnings and Cautions only.

## 2.4.2 Complete a task suggested in an Action Queue Item

When you complete a task stated in an Action Queue Item, the item is automatically removed from the Action Queue and the Alert Banner is closed.

Action Queue Items providing information about a slide will remain in the Action Queue until that slide has finished the run and is removed from the processing module.

For maintenance related tasks, refer to [4 Cleaning and maintenance](#).

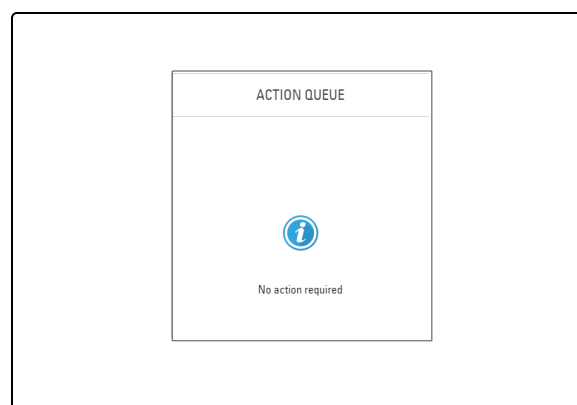
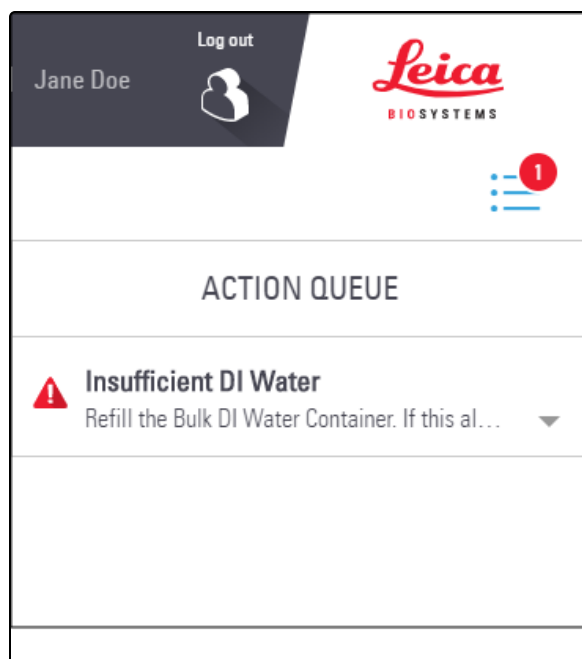

## 2.4.3 Manually hide the Alert Banner

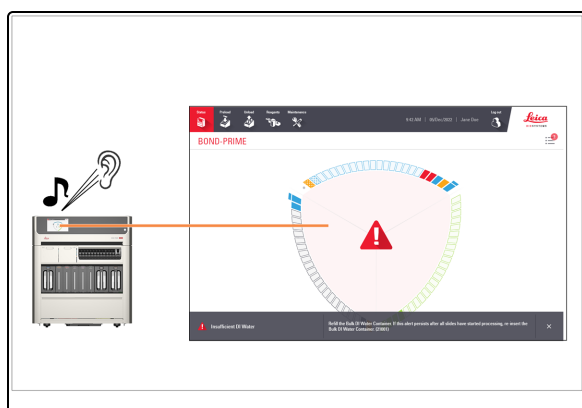

When the Alert Banner is displayed, an audible alarm sounds when immediate action is required.



1. Tap the X in the banner at the bottom of the screen.



Although the BOND-PRIME software allows you to manually hide the Alert Banner, Leica Biosystems Melbourne Pty Ltd recommends that you should, if possible, complete the suggested task.

Refer to [2.4.2 Complete a task suggested in an Action Queue Item](#).

## 2.5 Preload slides



**WARNING:** You must wear the minimum required Personal Protective Equipment (PPE) before you use reagents or operate the processing module. Refer to [General cautions](#).



Before you start this procedure, ensure you are logged in to the processing module. Refer to [2.1 Log in and log out](#).

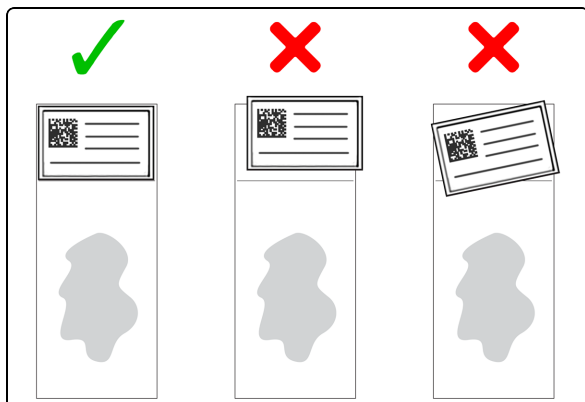

Make sure the slide labels are correctly affixed and positioned wholly on the slide.

Do not stack more than two labels on a slide.

Slides must be free of:

- excess moisture and debris, for example dust, wax and glass chips.
- sticky residue from removed/re-affixed labels.

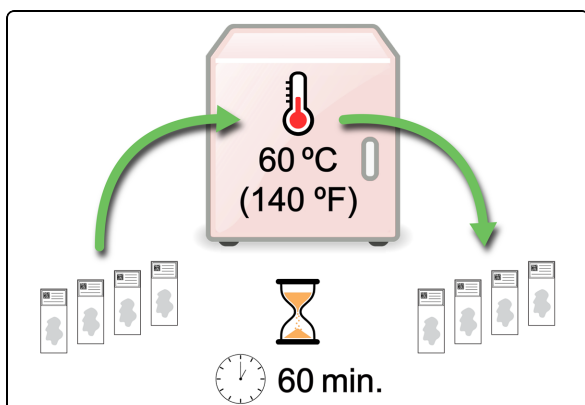

1. Bake slides at 60 °C (140 °F) for 60 minutes to improve tissue adhesion.



The Preload Drawer is the left-hand drawer.

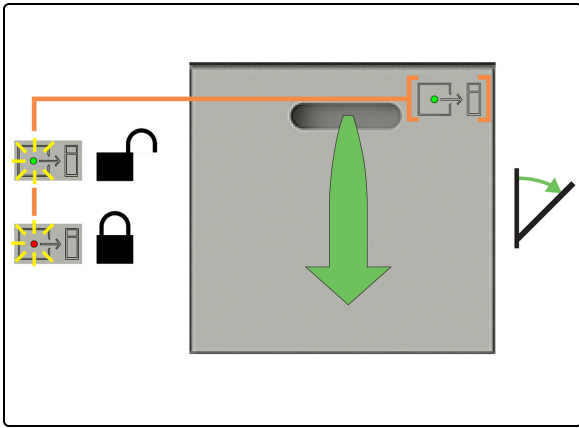

2. Check that the Preload Drawer status LED is green, and then pull the handle to open the drawer.

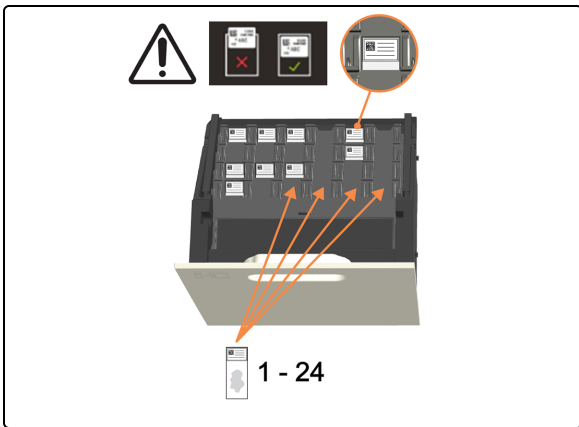

3. Preload 1 - 24 slides label-side-up into any empty positions. Make sure no labels overhang.

If there are any priority slides, preload these first and then close the Preload Drawer.



You can preload up to six dewaxed slides. Dewaxed slides must start processing within the "acceptable starting period", otherwise an alert appears on the touchscreen.



Slides that are scanned together are scheduled together.

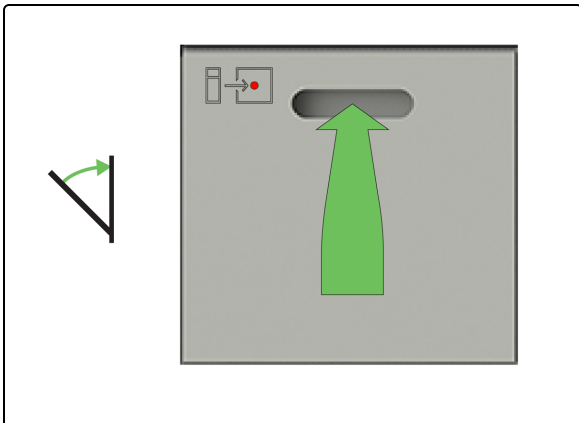

4. Check that all slides are correctly located in the Slide Drawer Insert, and then close the Preload Drawer.



## 2.6 Preload Screen

The Preload Screen has the following views:

- **Preload Drawer view**—displays a physical representation of the location of slides in the Preload Drawer
- **Preload Case view**—displays a physical representation of the location of each slide in each case in the Preload Drawer.

A toggle at the top of the screen allows you to switch views.



Loading slides together means they are scanned and then prioritized together. This enables the processing module to complete the last slide as efficiently as possible.



### Legend

- 1 2.6.1 Preload Drawer view
- 2 2.6.2 Preload Case view

## 2.6.1 Preload Drawer view

The Preload Drawer view shows the relationship between the slide positions shown on-screen and their actual positions in the Preload Drawer. Slides that are currently being evaluated show no details until the evaluation process is complete.

### Slide positions on the Preload Drawer view

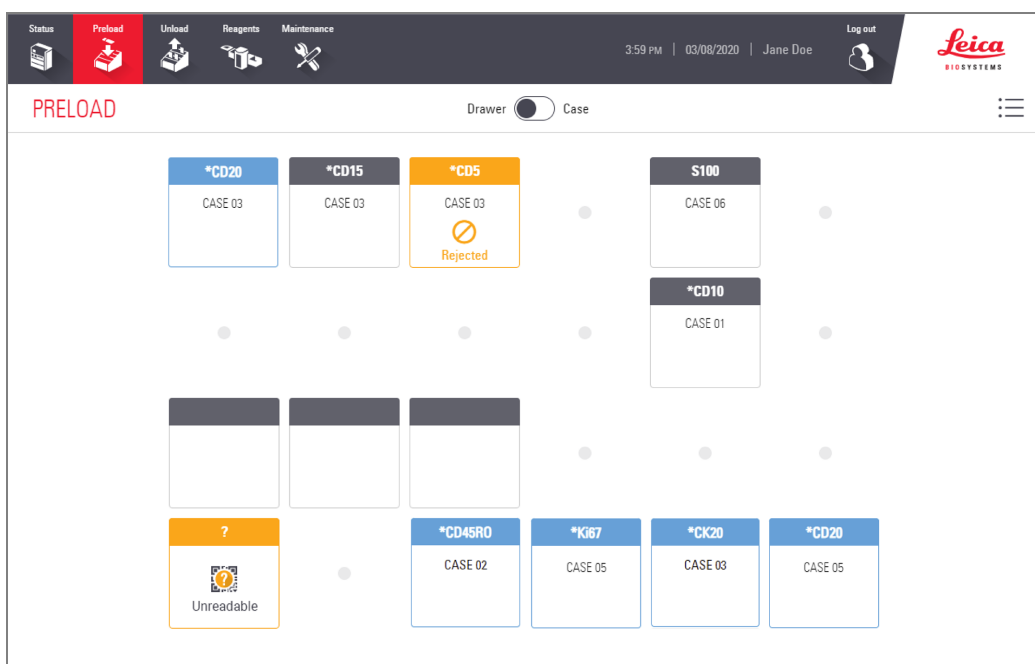

## Slide positions in the Preload Drawer

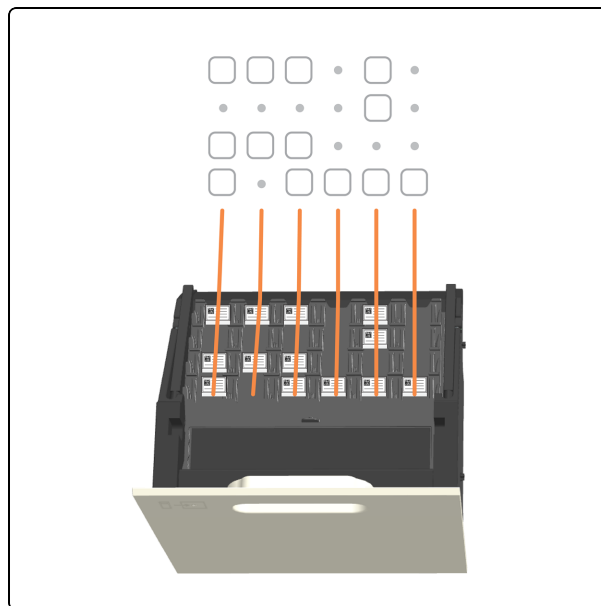





### See also:



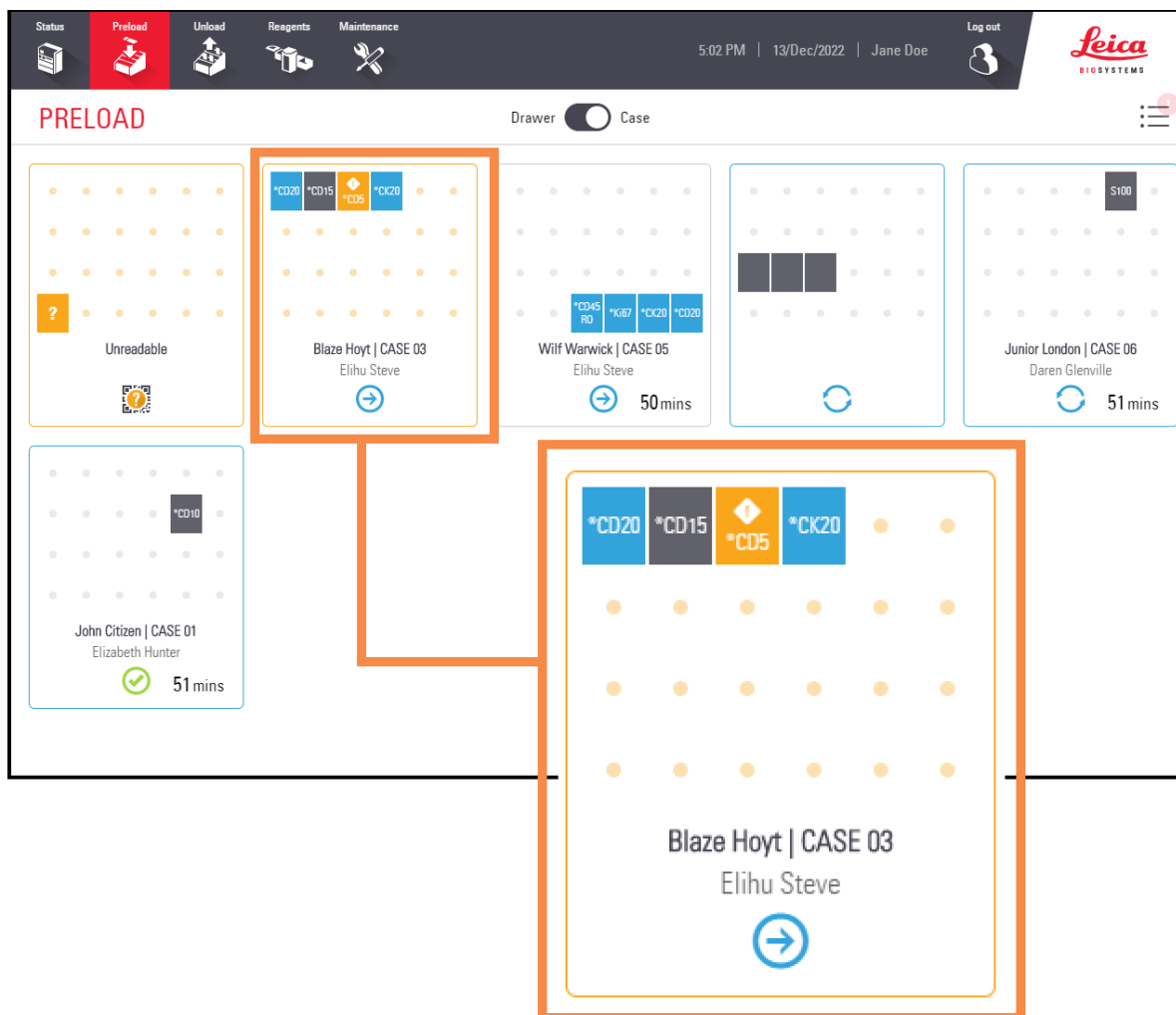



- [2.5 Preload slides](#)
- [2.9 Detailed case and slide information](#)

## 2.6.2 Preload Case view

Slide positions on the Preload Case view



Icon	Description
	Detected slide
	Unreadable slide
	Identified slide
	Accepted slide

Icon	Description
	Slide with status "Caution"
	Rejected slide
	Time-critical slide that is rejected
	One or more slides in this case are either completed, abandoned, or canceled
	Slide with status "Warning"
	Slides in this case are either accepted or evaluating
	Slides in this case are in progress

## See also:

- [2.5 Preload slides](#)
- [2.9 Detailed case and slide information](#)

## 2.7 Unload slides



**WARNING:** You must wear the minimum required Personal Protective Equipment (PPE) before you use reagents or operate the processing module. Refer to [General cautions](#).



Before you start this procedure, ensure you are logged in to the processing module. Refer to [2.1 Log in and log out](#).



1. The Unload Drawer is the right-hand drawer.

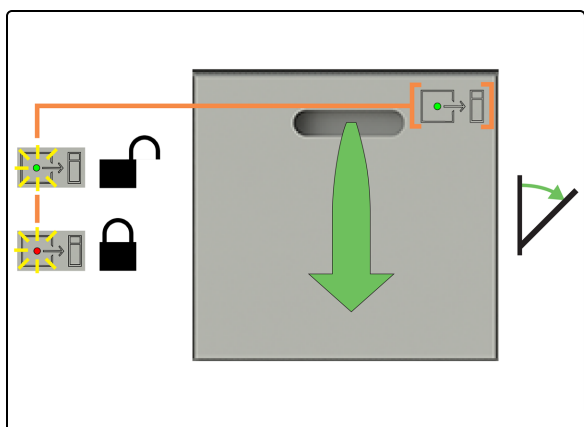

2. Check that the Unload Drawer status LED is green, and then pull the handle to open the drawer.

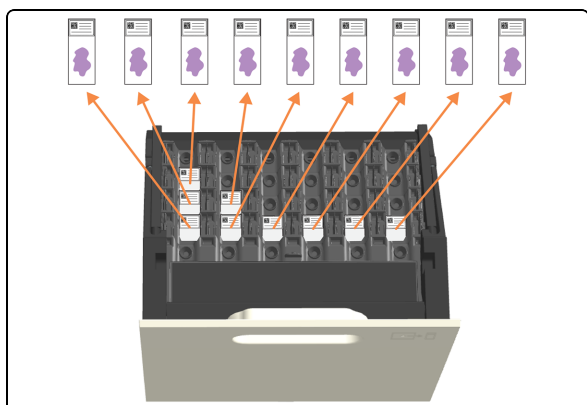

3. Unload **all** of the slides before closing the drawer, otherwise you will see an "Unexpected slide" warning.

If you do not unload all the slides, they will no longer be hydrated and staining quality could be compromised.

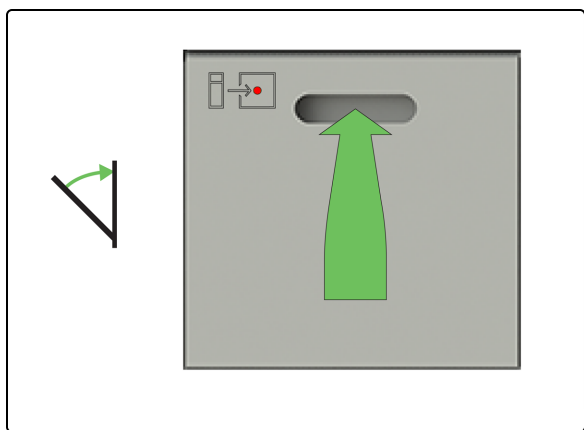

4. Close the Unload Drawer.

## 2.8 Unload Screen

The Unload Screen has the following views:

- **Unload Drawer view**—displays a physical representation of the location of slides in the Unload Drawer
- **Unload case view**—displays a physical representation of the location of each slide in each case in the Unload Drawer.

A toggle at the top of the screen allows you to switch views.



### Legend

- 1 2.8.1 Unload Drawer view
- 2 2.8.2 Unload case view



## 2.8.1 Unload Drawer view

The Unload Drawer view shows the relationship between the slide positions shown on-screen and their actual positions in the Unload Drawer.

### Slide positions on the Unload Drawer view

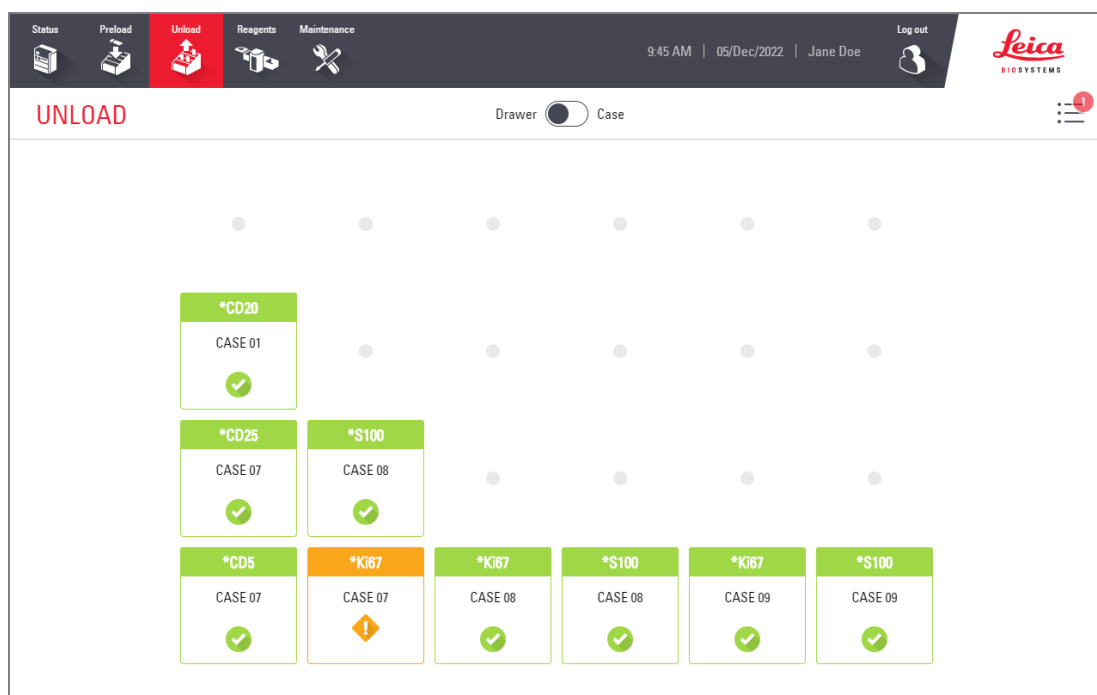

### Slide positions in the Unload Drawer

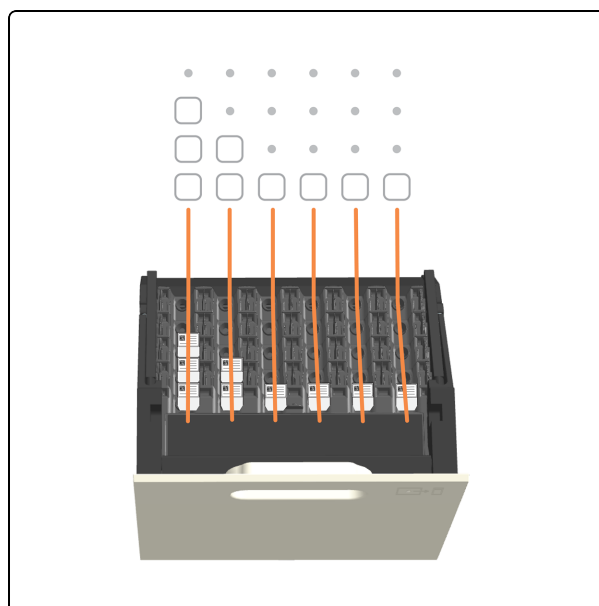





## See also:



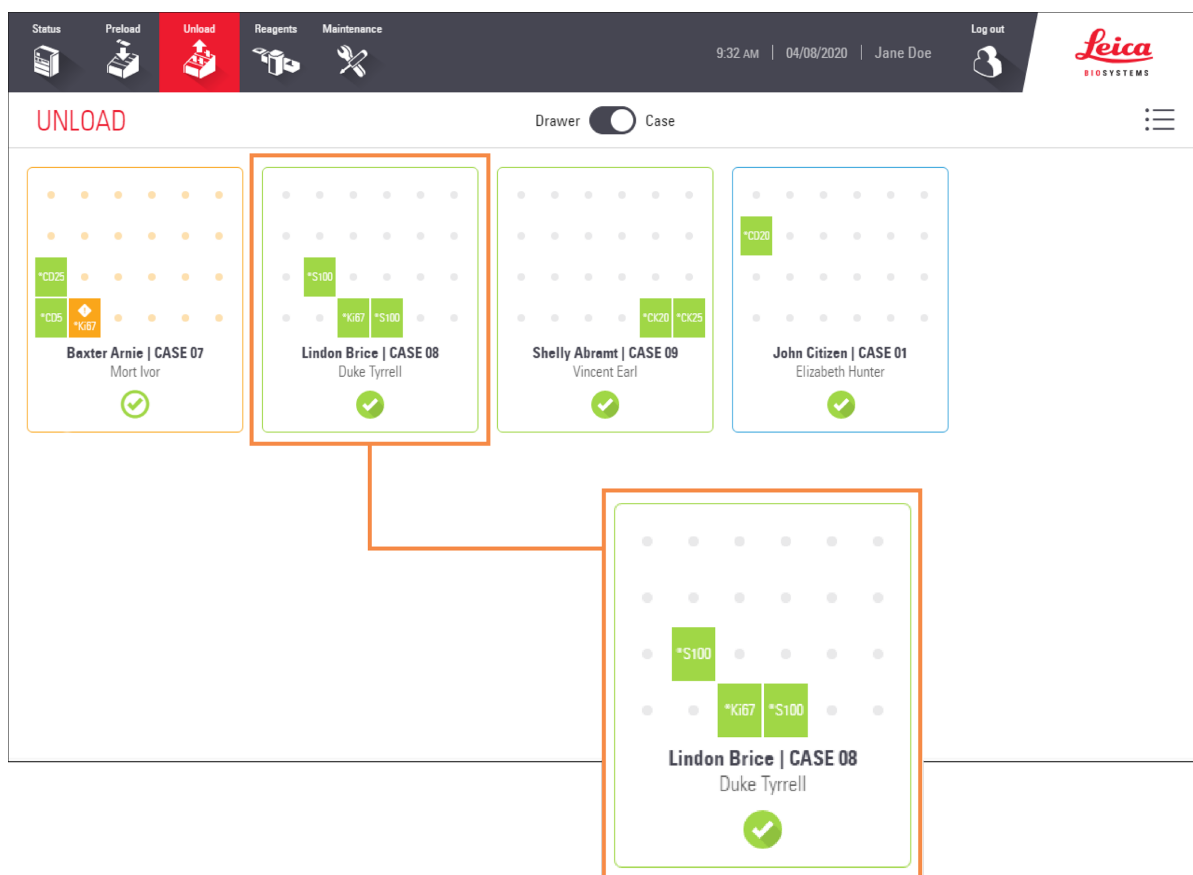

- [2.7 Unload slides](#)
- [2.9 Detailed case and slide information](#)
- [2.3.5 Unexpected events during processing](#) (slides with status "Caution")

## 2.8.2 Unload case view

### Slide positions on the Unload Case view



Icon	Description
	Completed slide
	Slide with status "Caution"
	Canceled, or slide with status "Warning"

Icon	Description
	Slides in this case will be processed
	Slides in this case are in progress
	Some slides in this case have successfully completed processing
	All slides in this case have successfully completed processing
	Unexpected slide - refer to <a href="#">2.7 Unload slides</a>

## See also:

- [2.7 Unload slides](#)
- [2.9 Detailed case and slide information](#)
- [2.3.5 Unexpected events during processing](#) (slides with status "Caution")

## 2.9 Detailed case and slide information

To view more detailed case and slide properties, you can tap on:

- the basic slide information on the Status screen
- a slide icon on the Preload or Unload screen (drawer or case view) - the selected slide is highlighted in the information window that appears
- a case tile on the Preload or Unload screen (case view) - the first slide in the case is highlighted in the information window that appears

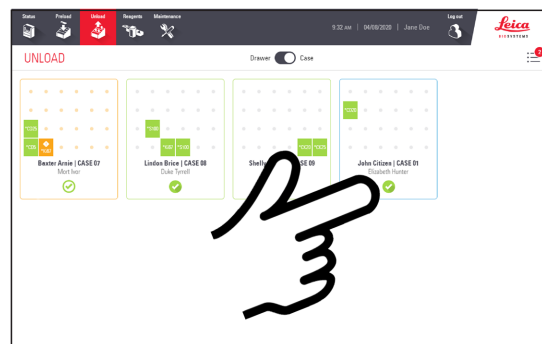
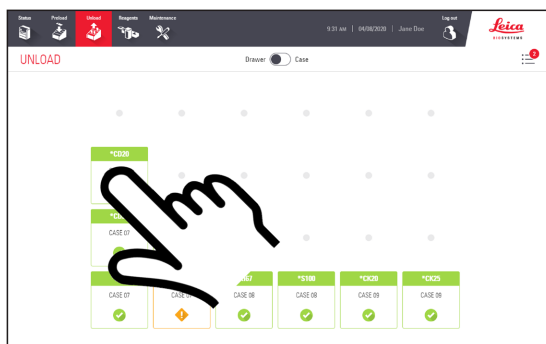
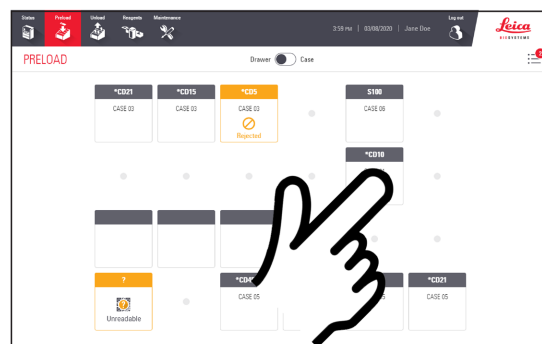
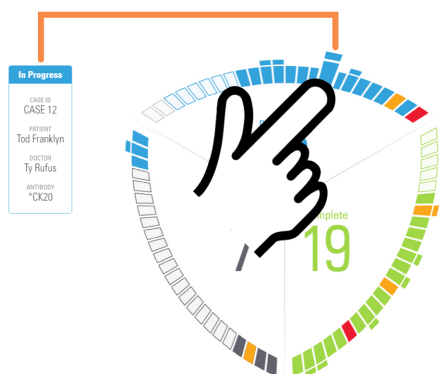

- 1 Tap a slide in the information window to view its details.

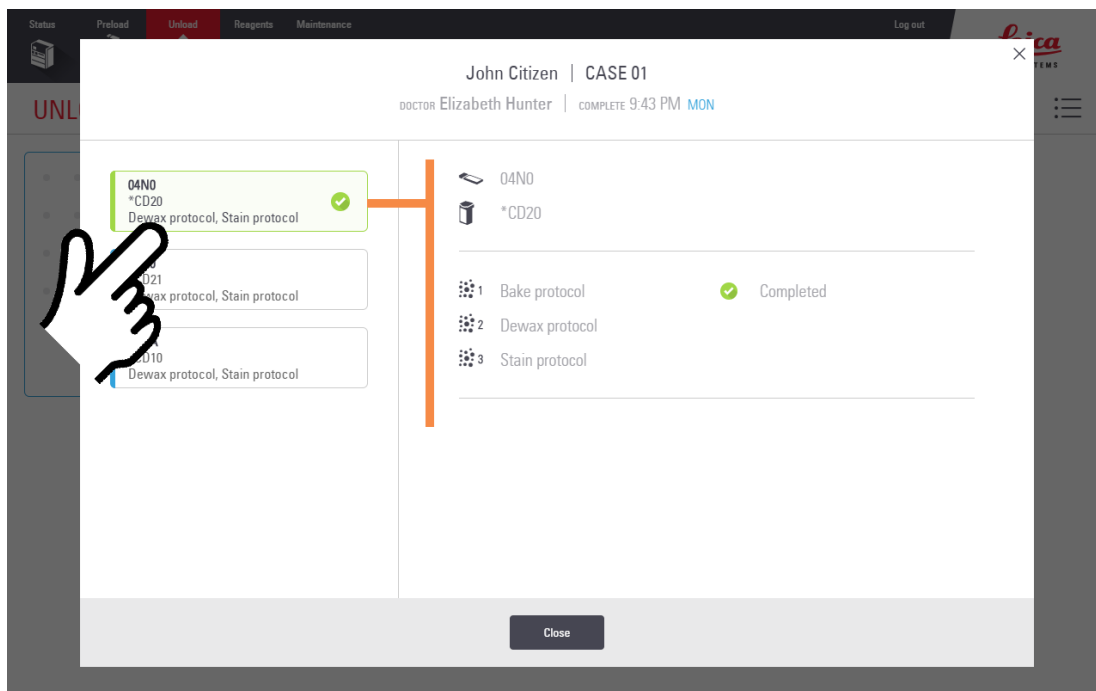

## See also:

- [2.9.1 View each slide in a case](#)
- [2.9.2 Stop a slide in progress](#)

## 2.9.1 View each slide in a case

1. Tap a slide to display the details of that slide.

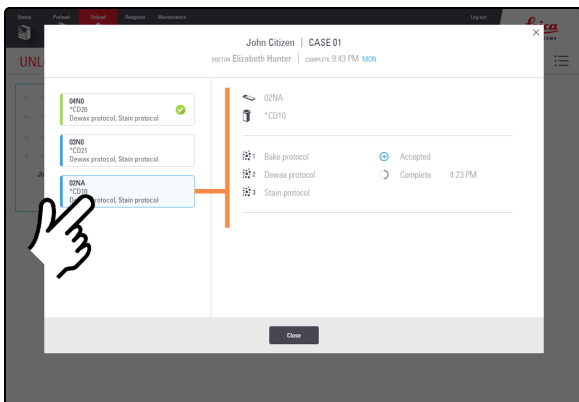
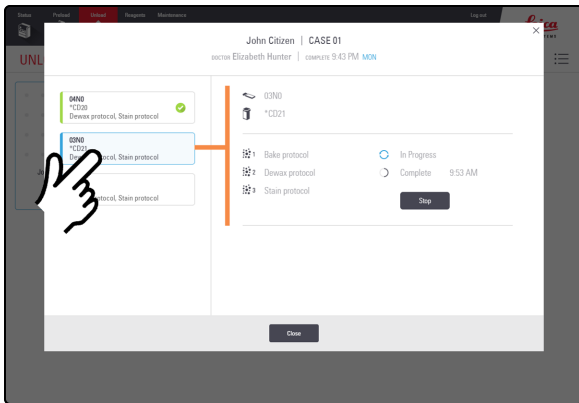
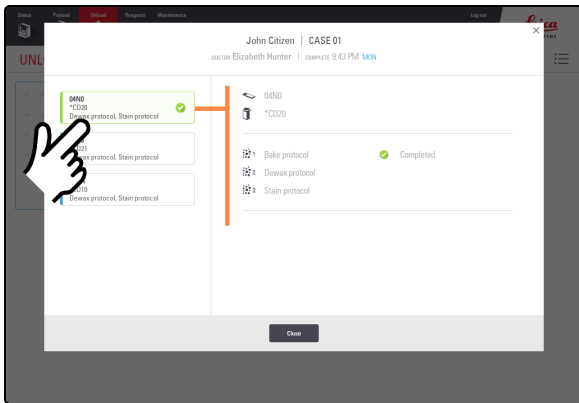

## 2.9.2 Stop a slide in progress

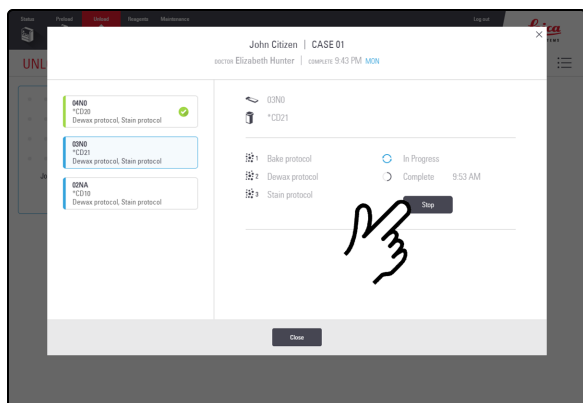

1. On the Case Details screen, select the slide, and then tap **Stop**.

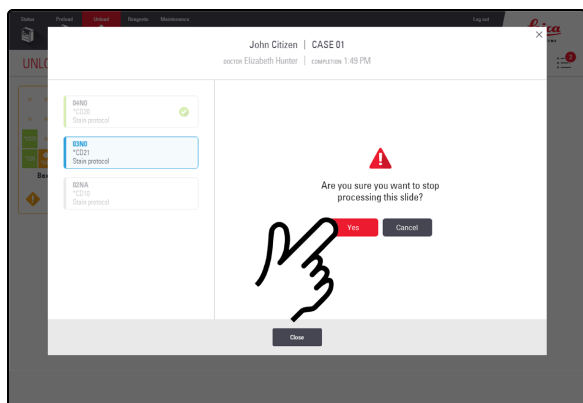

2. Tap **Yes**.

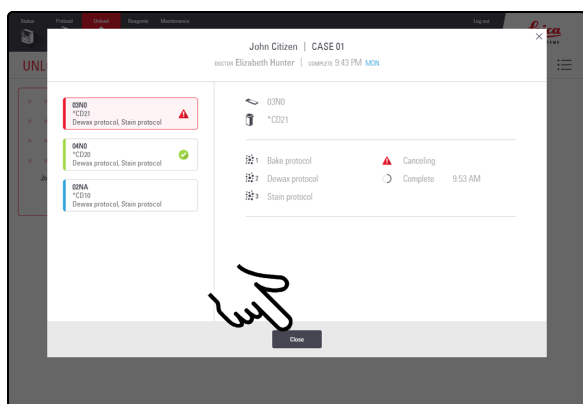

3. Tap **Close**.

A canceled slide will be transferred to the Unload Drawer and will be shown in red.



## 2.10 Reagents Screen

### 2.10.1 Prepare Reagent Container and Reagent Trays



**WARNING:** You must wear the minimum required Personal Protective Equipment (PPE) before you use reagents or operate the processing module. Refer to [General cautions](#).

#### Single Reagent Tray

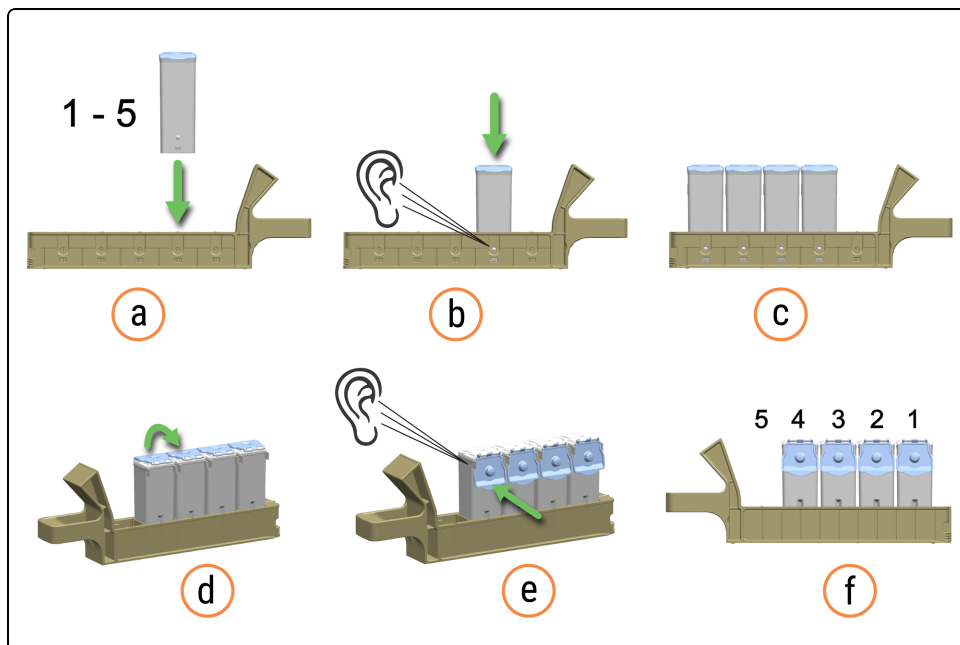



## Dual Reagent Tray



**WARNING:** Pinch hazard when closing a Dual Reagent Tray.

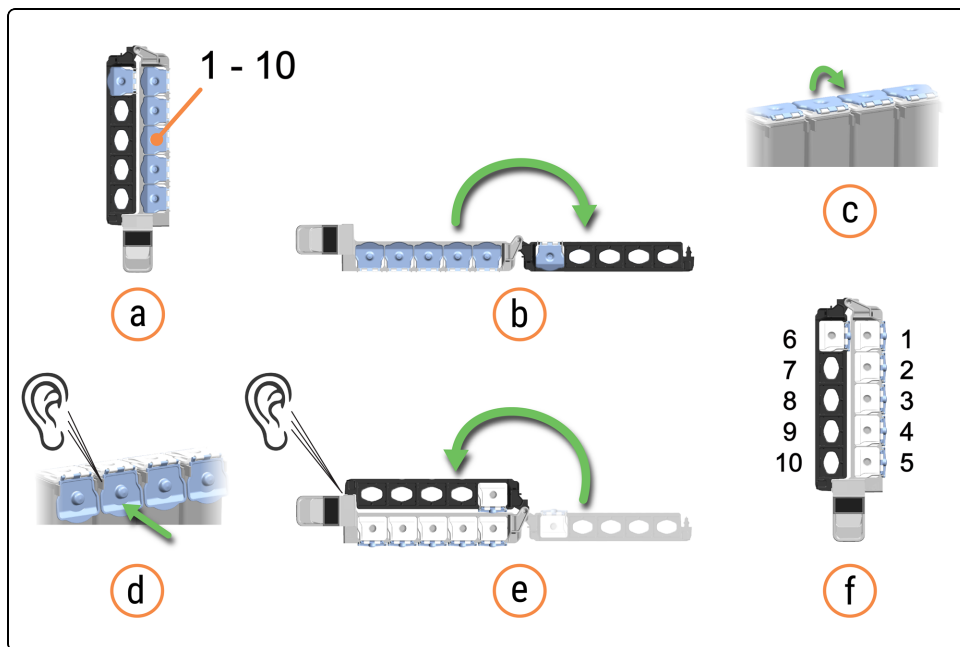

You will hear a click when you fully insert a Reagent Container into a Reagent Tray. Make sure that the Reagent Container lids click fully into the tabs at the backs of the containers. If you do not, the lids may interfere with the alignment of the reagent containers in adjacent Reagent Lanes.

There is also a click when you fully close a Dual Reagent Tray.

Make sure the top barcode labels are fully adhered to the containers – press down any labels that are lifting.

Wipe any moisture/condensation from the top barcode label.

## 2.10.2 Load Reagent Trays



**WARNING:** You must wear the minimum required Personal Protective Equipment (PPE) before you use reagents or operate the processing module. Refer to [General cautions](#).

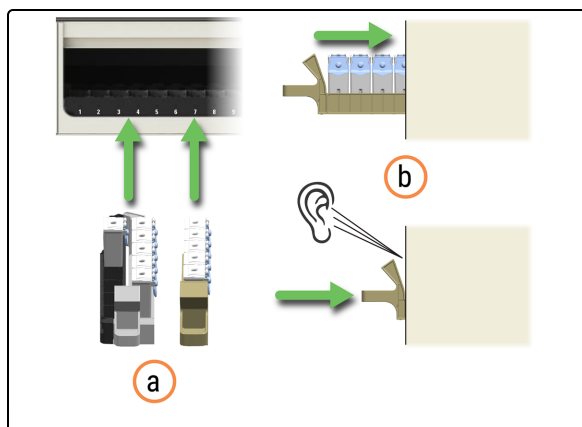

1. Load both Reagent Trays onto the processing module.
  - a. Place the Reagent Tray in the Reagent Platform.
  - b. Push the Reagent Tray until you hear a click.



The Reagents screen displays the loaded reagents and detection system.

When loading a Reagent Tray, follow a smooth motion to avoid potential reagent spillage and contamination. You will hear a click when you fully insert a Reagent Tray into the Reagent Platform.

The background color of the on-screen icon is related to the contents of the loaded reagent system or container. Also, the background color changes if the reagent system or container is allocated to one or more slides. If a Reagent Tray or Reagent Container is unallocated, the icon's background color is light-gray.

The darker horizontal bar across the top of the icon represents the remaining reagent volume. A shorter bar indicates less remaining volume.

The time (in hours and minutes) that the Reagent Tray will be in use and locked is displayed underneath the Reagent Lanes. There is also red LED for that lane on the Reagent Platform.

If a reagent is not registering after a few minutes, remove the Reagent Tray and re-insert it into a different Reagent Lane, to re-trigger the reagent scans.

## 2.10.3 Examples of reagent system icons

Allocated BOND-PRIME Polymer DAB Detection System  
(Dual Reagent Tray)

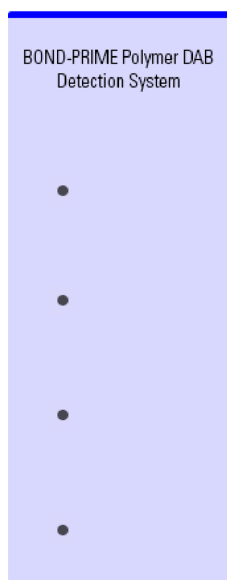

Unallocated BOND-PRIME Cleaning Kit  
(Single Reagent Tray)

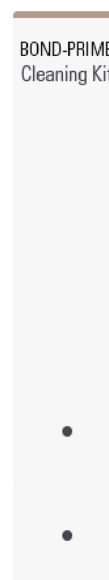

## 2.10.4 Examples of Reagent Container icons



Vacant Reagent Tray position



Unallocated Reagent Container



Allocated Reagent Container



Unrecognized Reagent Container



Invalid or expired Reagent Container (or reagent system)



Reagent not registered

## 2.10.5 View reagent system and Reagent Container details

### Reagent System Details

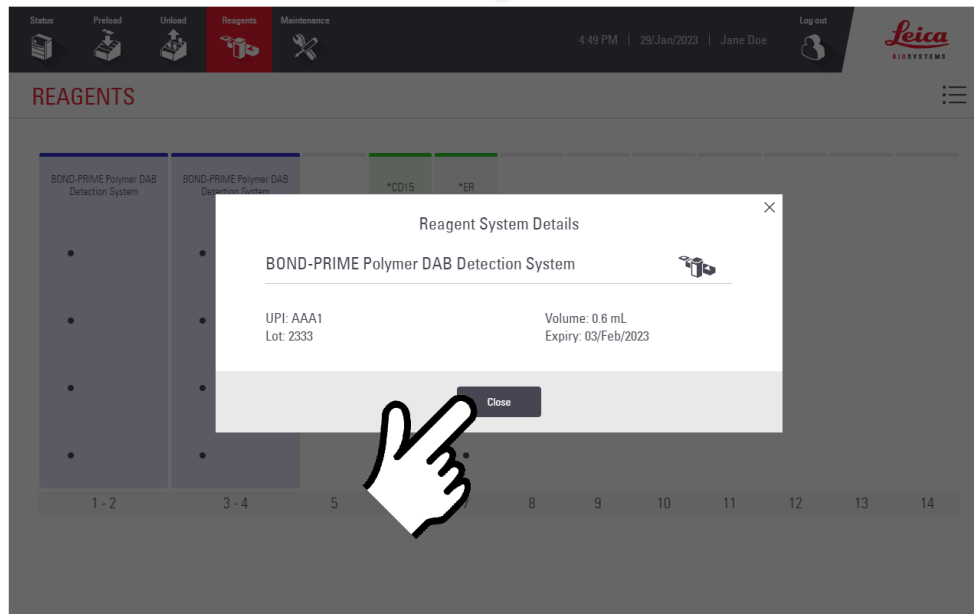
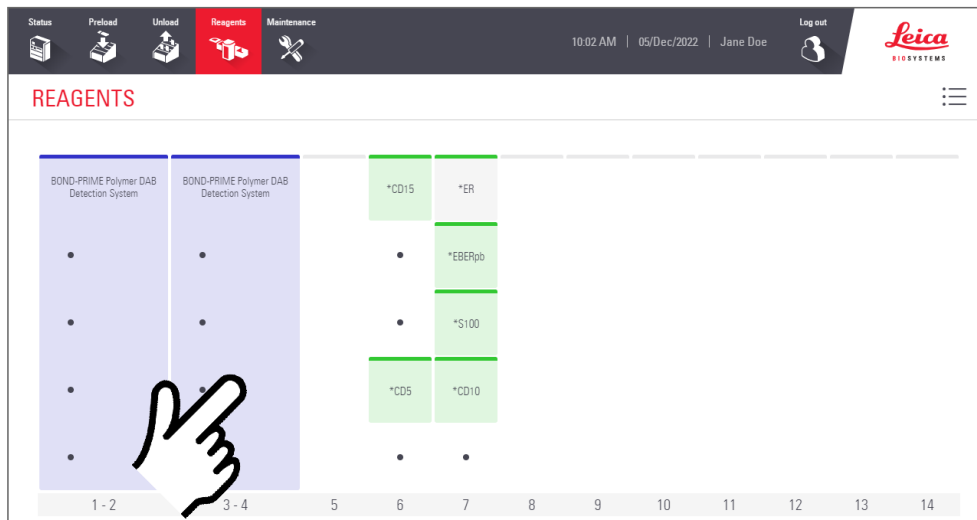

# Reagent Details

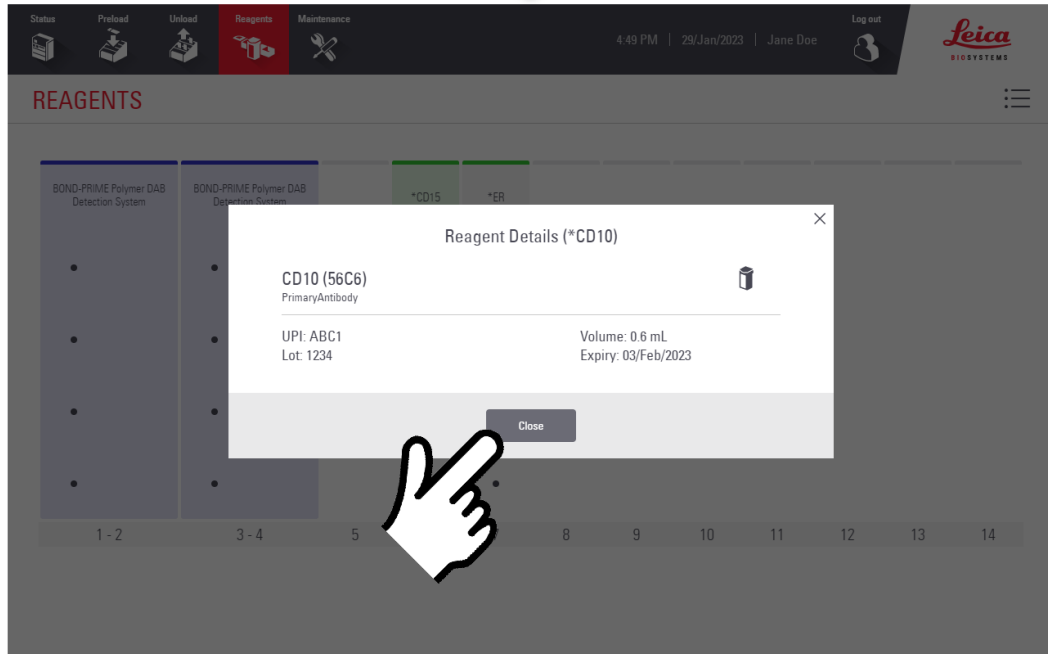
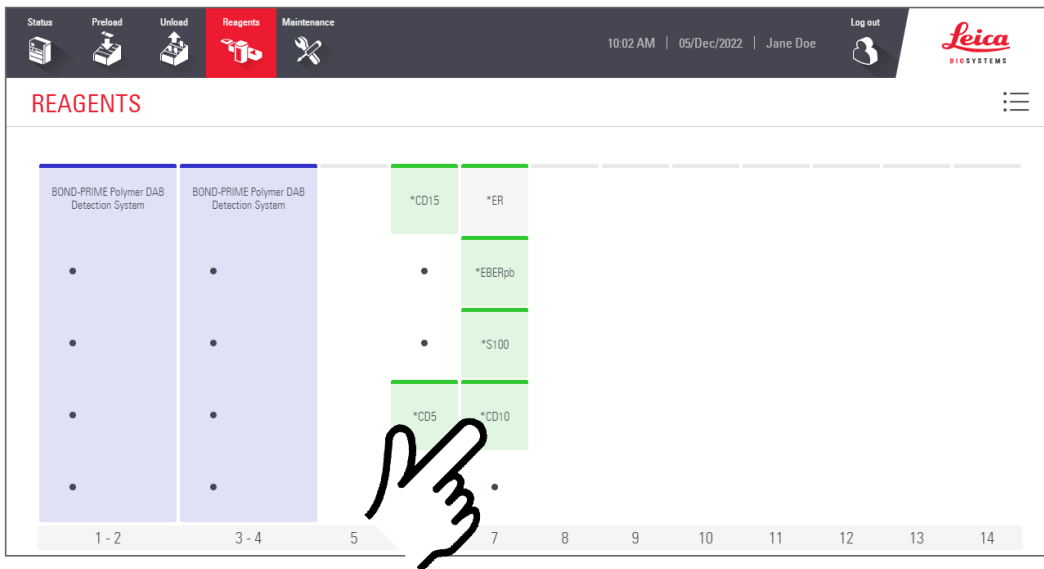

## 2.10.6 Unload Reagent Trays



**WARNING:** You must wear the minimum required Personal Protective Equipment (PPE) before you use reagents or operate the processing module. Refer to [General cautions](#).

The time a Reagent Tray is expected to be in use is displayed on the Reagents Screen. When it is no longer in use, you can remove the tray.

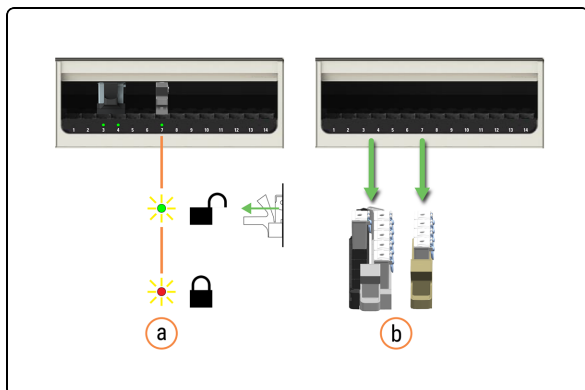

1. Remove the Reagent Trays from the processing module.
  - a. Wait until the Reagent Lane LED is green.
  - b. Remove the Reagent Trays from the Reagent Platform.

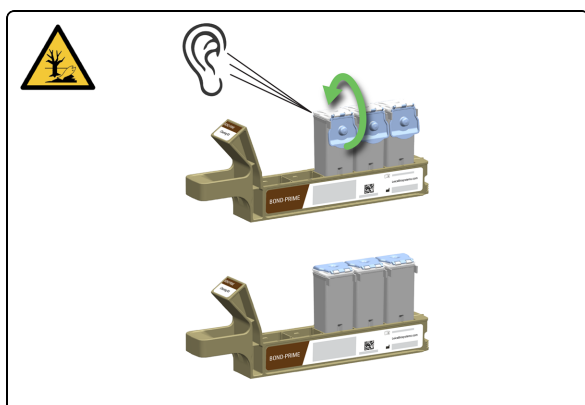

2. Close the Reagent Container lids firmly to prevent reagent evaporation. You will hear a click when you fully close the lid.

Immediately store the reagents as recommended on the label or reagent data sheet.

## 2.11 Maintenance Screen

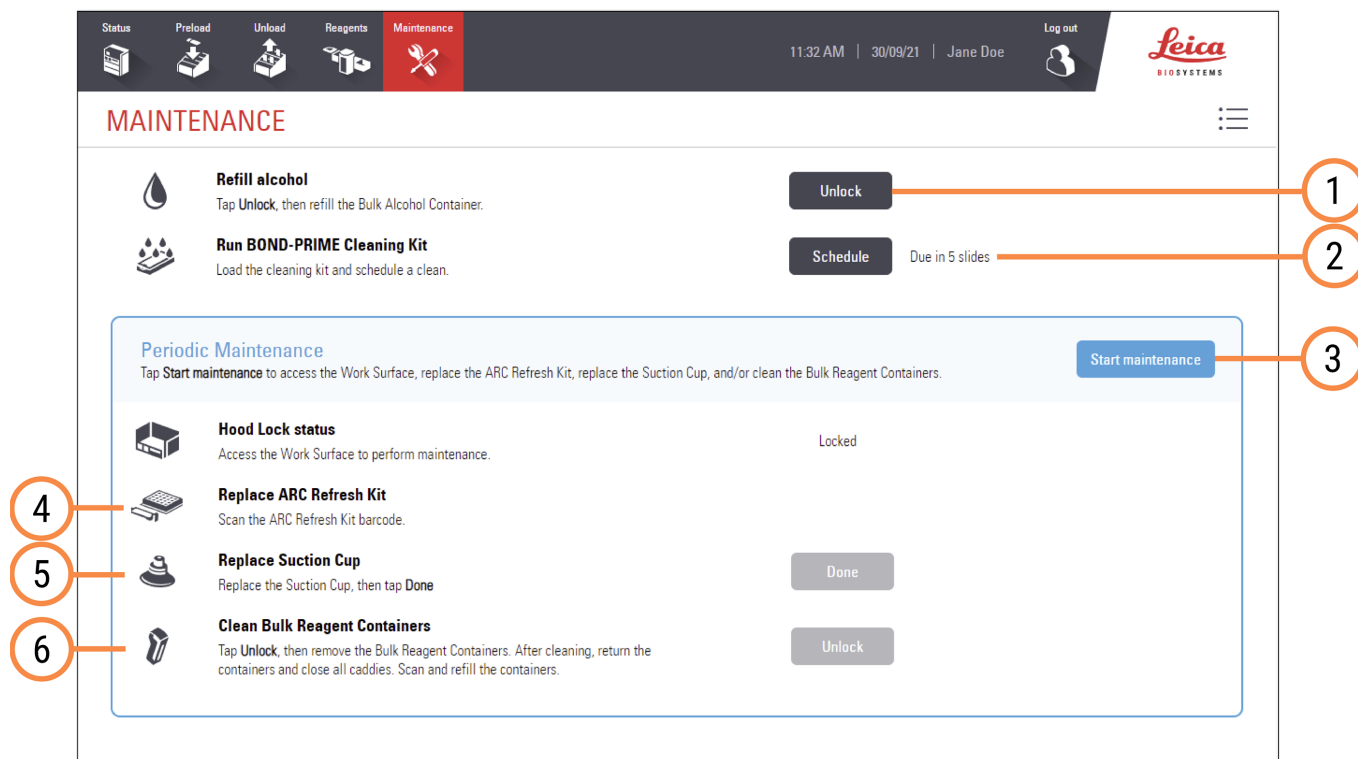

### Legend

- |   |                                                        |   |                                                                                       |
|---|--------------------------------------------------------|---|---------------------------------------------------------------------------------------|
| 1 | <b>Unlock</b><br>4.3 Refill the Alcohol Container      | 4 | <b>Replace ARC Refresh Kit</b><br>4.14 Use the BOND-PRIME ARC Refresh Kit             |
| 2 | <b>Schedule</b><br>4.6 Use the BOND-PRIME Cleaning Kit | 5 | <b>Replace Suction Cup</b><br>4.11 Replace the Suction Cup                            |
| 3 | <b>Start maintenance</b><br>4.7 Start Maintenance      | 6 | <b>Clean Bulk Reagent Containers</b><br>4.16 Clean the Locked Bulk Reagent Containers |

# 3

## Quick start



**WARNING:** You must wear the minimum required Personal Protective Equipment (PPE) before you use reagents or operate the processing module. Refer to [General cautions](#).

In this section:

3.1 Introduction .....	97
3.2 Start the processing module .....	98
3.3 Load the Reagent Tray and DS9824 Detection System .....	100
3.4 Preload, process, and unload the slides .....	102



## 3.1 Introduction

This chapter shows you how to do an example run on the BOND-PRIME Processing Module.

You will create a sample case and configure and process four slides.

The process uses four BOND ready-to-use primary antibodies:

- \*CD5
- \*CD3
- \*CD10
- \*Bcl-6

The process uses the default protocol and detection system for these antibodies:

- \*IHC Protocol F
- BOND-PRIME Polymer DAB Detection System (DS9824)

The process uses the ancillary BOND-PRIME Hematoxylin (AR0096).

The procedure is also applicable for ISH probes and protocols.

You can interchange the antibody for a probe and replace IHC protocols with ISH protocols.

For details of the following preliminary tasks, refer to the Quick Start chapter in the *BOND 7 User Manual*:

- Preliminary Checks and Startup\*
- Protocol and Reagent Checks
- Setting Up Slides (up to and including labeling slides)



To improve tissue adhesion, try baking for longer before loading slides.

\* related only to the Slide Labeler and BOND Controller (and Terminal, for BOND-ADVANCE)

## 3.2 Start the processing module

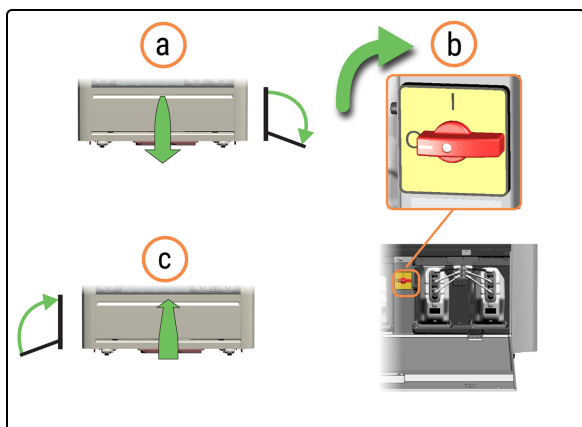

1. Power on the processing module.
  - a. Open the Reservoir Cabinet door.
  - b. Turn the AC power switch clockwise.
  - c. Close the Reservoir Cabinet door.



2. When the processing module is turned on, it initializes before displaying the Log In Screen. This process takes from 8 to 15 minutes. If the processing module fails to initialize, refer to [5.1 Failure to initialize](#).

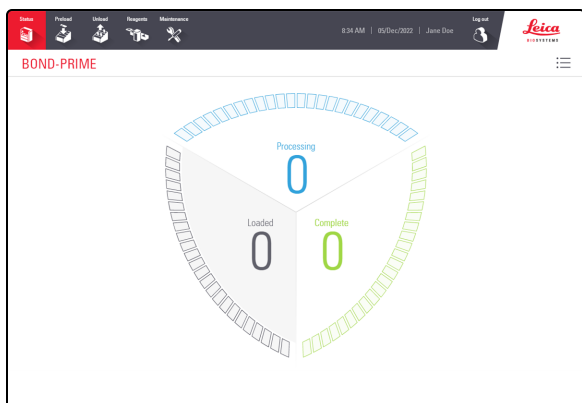

The Status screen is displayed.

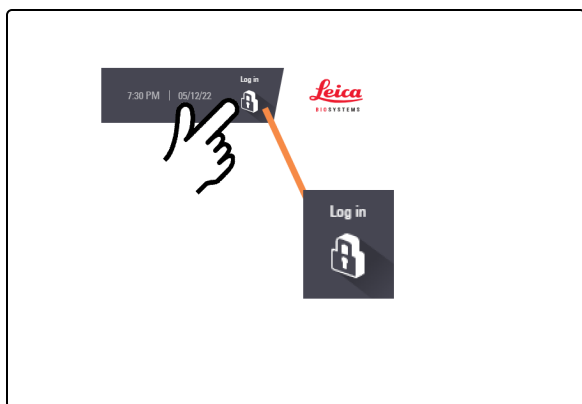

3. When the processing module has initialized, tap **Log in**.



4. Log in to the touchscreen.

- a. In the **Log in** Screen, tap your user name.
- b. Enter your PIN.

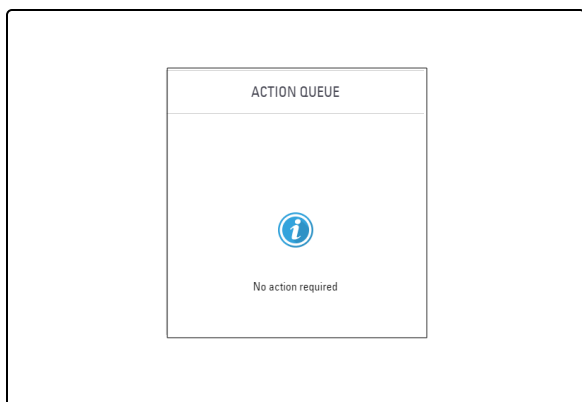

5. Complete any Action Queue tasks that show action is required.

If the action specified in the Action Queue is maintenance-related, refer to [4 Cleaning and maintenance](#)

Action Queue Item status icon:



**Warning:** Take immediate action.



**Caution:** Take action at your next opportunity.



**Information:** For your awareness.



If the processing module does not initialize, refer to [5.1 Failure to initialize](#).

## 3.3 Load the Reagent Tray and DS9824 Detection System

Load reagents at the start of a run (before loading slides) to allow time for volume checks.

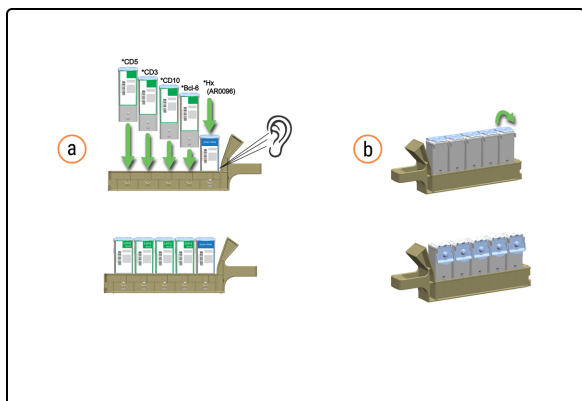

1. Load the Reagent Tray.
  - a. Insert the Reagent Containers into the Reagent Tray. Listen for a clicking sound to confirm the container is fully inserted.
  - b. Open all container lids.

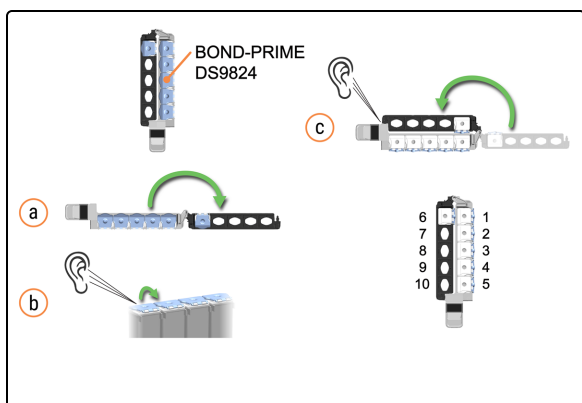

2. Load the BOND-PRIME Polymer DAB Detection System (DS9824) .
  - a. Open the Detection System.
  - b. Open all container lids.
  - c. Close the Detection System.



DS9824 has only 6 containers:

- Peroxide Block
- Post Primary
- Polymer
- DAB Part 1
- DAB Part B x 2

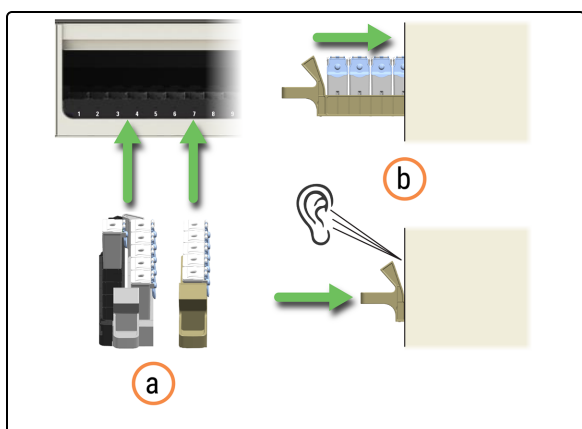

3. Load both Reagent Trays onto the processing module.
  - a. Place the Reagent Tray in the Reagent Platform.
  - b. Push the Reagent Tray until you hear a click.



The Reagents screen displays the loaded reagents and detection system.

## 3.4 Preload, process, and unload the slides

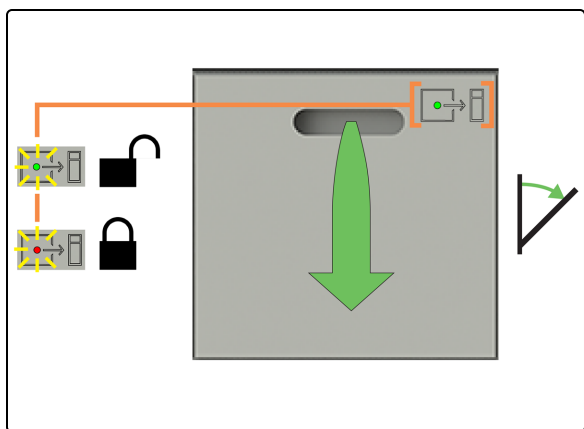

1. Check that the Preload Drawer status LED is green, and then pull the handle to open the drawer.

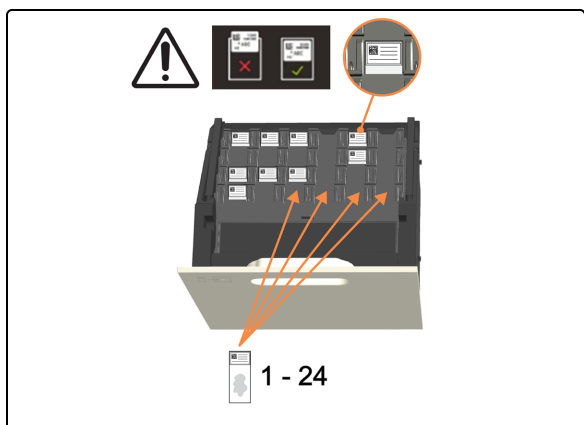

2. Preload 1 - 24 slides label-side-up into any empty positions. Make sure no labels overhang.

If there are any priority slides, preload these first and then close the Preload Drawer.



You can preload up to six dewaxed slides. Dewaxed slides must start processing within the "acceptable starting period", otherwise an alert appears on the touchscreen.



Slides that are scanned together are scheduled together.

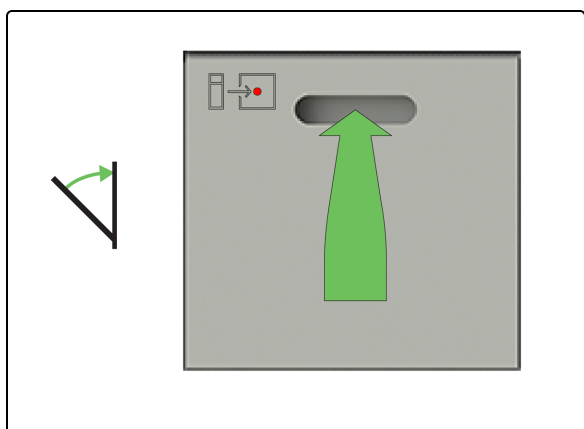

3. Check that all slides are correctly located in the Slide Drawer Insert, and then close the Preload Drawer.

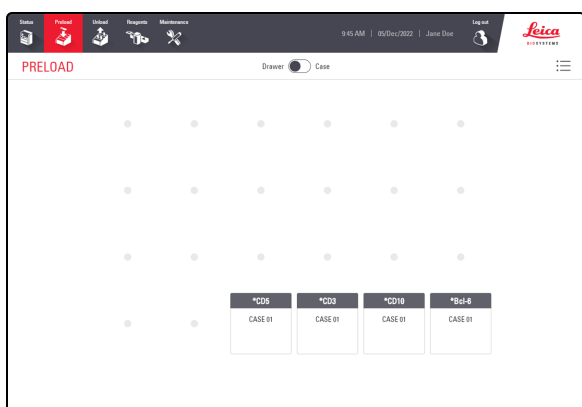

The Preload screen is automatically displayed when the Preload Drawer is opened.

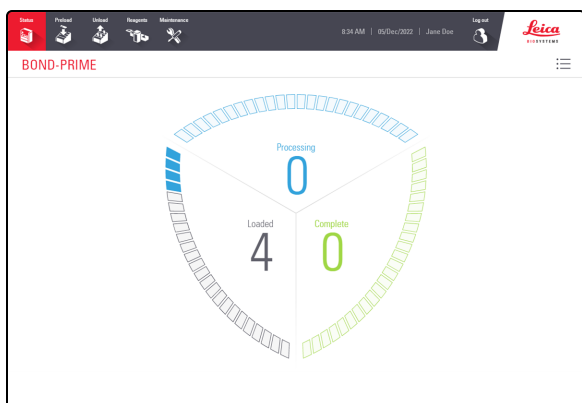

4. Tap **Status** to view the slide processing status. When slides are in the Preload Drawer, they are displayed in the Loaded area of the screen.

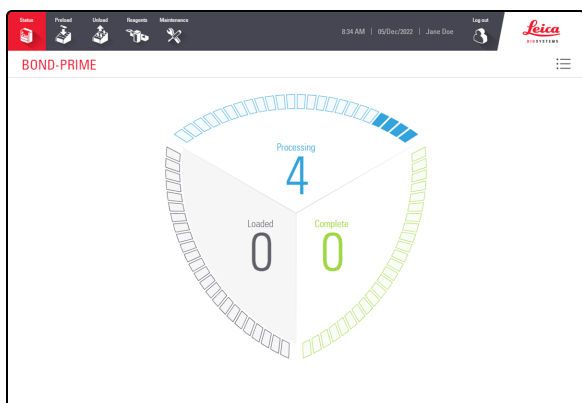

When slides are being processed on the Work Surface, they are displayed in the Processing area of the screen.

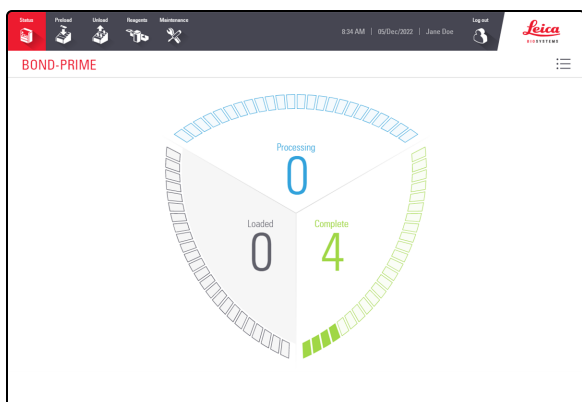

When slides are in the Unload Drawer, they are displayed in the Complete area of the screen.

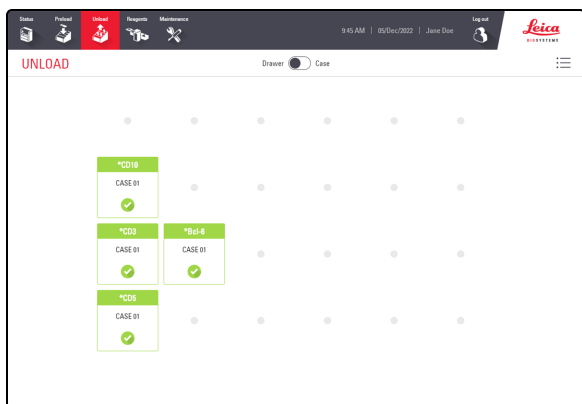

5. Tap **Unload** to view the position of each slide in the Unload Drawer.

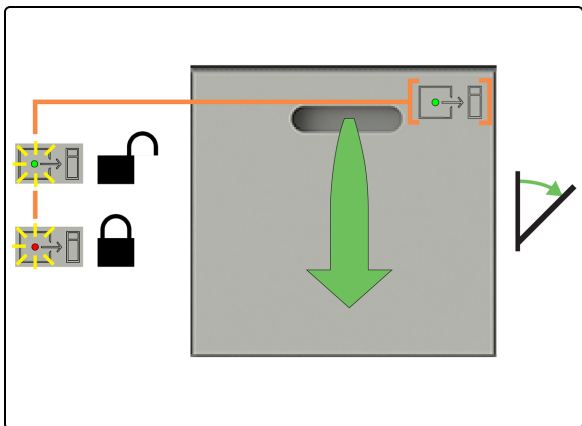

6. Check that the Unload Drawer status LED is green, and then pull the handle to open the drawer.

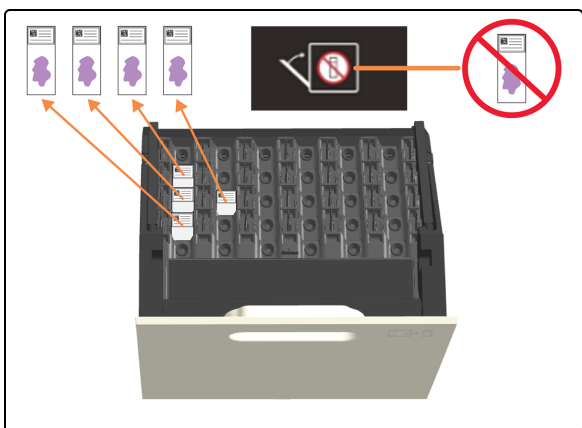

7. Remove all slides from the Unload Drawer.  
Unload **all** completed slides frequently. If the Unload Drawer reaches capacity, it can hinder processing, extending the Estimated Time of Completion. When you close the Unload Drawer, it **must not** contain any slides.

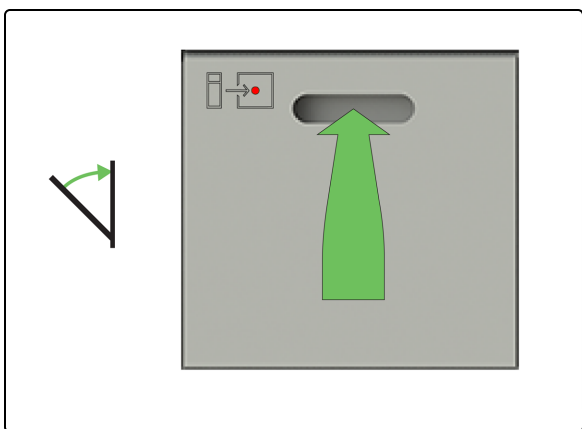

8. Close the Unload Drawer.





When you have finished unloading the slides, check the Reagents screen to determine if there are any reagents that are no longer required for use. If there are, unload the reagents and then close Reagent Container lids firmly to prevent reagent evaporation. Immediately store the reagents as recommended on the label or reagent data sheet.

# 4

## Cleaning and maintenance



**WARNING:** You must wear the minimum required PPE before you maintain the processing module. Refer to [General cautions](#).

In this section:

4.1 Maintenance schedules .....	107
4.2 Refill the DI Water Container .....	110
4.3 Refill the Alcohol Container .....	112
4.4 Refill the Lot Tracked Bulk Containers .....	115
4.5 Empty the Waste Containers .....	118
4.6 Use the BOND-PRIME Cleaning Kit .....	120
4.7 Start Maintenance .....	124
4.8 Wipe internal surface of ARC Modules .....	126
4.9 Wipe down Reagent Platform and ARC Bank Surfaces .....	130
4.10 Clean the Suction Cup .....	134
4.11 Replace the Suction Cup .....	138
4.12 Clean the Slide Drawer Inserts, Waste Drains and Sumps, and Pickup Filter .....	142
4.13 Clean the Wash/Prime Stations .....	151
4.14 Use the BOND-PRIME ARC Refresh Kit .....	155
4.15 Clean the Bulk DI Water Container .....	160
4.16 Clean the Locked Bulk Reagent Containers .....	163
4.17 Clean the Waste Containers .....	173
4.18 Clean the Sump Tray .....	176
4.19 Stop maintenance .....	178
4.20 Shutdown the processing module .....	180
4.21 Replace power supply fuses .....	182

## 4.1 Maintenance schedules

### 4.1.1 Preventative service reminder

When you use the BOND-PRIME Processing Module, look for leaks and worn or damaged parts. This user manual contains instructions that tell you how to clean or replace some parts. Notify customer support if it is necessary to repair or replace other parts.

A Leica Biosystems Melbourne Pty Ltd service engineer must regularly do preventative maintenance on the BOND-PRIME Processing Module.

Perform preventative maintenance annually or at 20,000 slides (whichever occurs first).

### 4.1.2 Cleaning and maintenance schedule

Use this schedule if you stain approximately 300 slides a week on each processing module. If you stain more slides than this, notify customer support. They can supply a customized schedule. Also refer to [4 Cleaning and maintenance](#).



If you stain more than 300 slides per week, do the tasks below that are marked with an asterisk more frequently.

#### Daily

- Examine the [Action Queue and Alert Banner](#) on the [Status Screen](#) and do the applicable [Cleaning and maintenance](#) as required. You should also do this whenever you return to the processing module during the workday.

#### As required (ensure the processing module is connected to the BOND Controller)

- Refill Bulk DI Water Container
- Refill Bulk Alcohol Container
- Refill Bulk Reagent Containers
- Empty Waste Containers

#### Weekly

- Wipe internal surface of ARC Modules
- Wipe down Reagent Platform and ARC Bank Surfaces
- Clean Suction Cup

## 2-monthly

- Replace Suction Cup (3400 slides)
- Clean Slide Drawer Inserts, Waste Drain and Sumps, and Unload Drawer Pickup Filter\*
- Clean Wash/Prime Stations\*
- Clean Sump Tray\*
- Clean external surfaces with a duster or cloth
- Clean Barcode Scanner (on Hood) using a lint-free cloth moistened with DI water

## 6-monthly (or if the processing module is idle for more than 14 days)

- Clean all bulk containers, including waste containers
- Clean hand-held barcode scanner (connected to BOND Controller) using a lint-free cloth moistened with DI water

## 8-monthly/7500 slides

- Use the BOND-PRIME ARC Refresh Kit (replace Mixing Well Plate and ARC Covertiles)

## When you see a notification in the Action Queue

- Use the BOND-PRIME Cleaning Kit



ARC Modules must be cleaned when the usage count is between 17 and 23.

For a complete list of cleaning and maintenance tasks, refer to [4 Cleaning and maintenance](#).



You can print the next page and use it as a checklist. You can also record the lot numbers of BOND-PRIME Wash Solution Concentrate, ER1, ER2 and Dewax Solutions.

## 4.1.3 Cleaning and maintenance checklist

DAILY/AS REQUIRED	Mon	Tues	Wed	Thurs	Fri	Sat	Sun
	<input type="checkbox"/>	<input type="checkbox"/>	<input type="checkbox"/>	<input type="checkbox"/>	<input type="checkbox"/>	<input type="checkbox"/>	<input type="checkbox"/>
Examine Action Queue and Alert Banner							
Refill/empty bulk containers as required							
BOND-PRIME Wash Solution Concentrate lot number							
ER1 lot number							
ER2 lot number							
Dewax Solution lot number							
<b>WEEKLY</b>							
Wipe internal surface of ARC Modules	<input type="checkbox"/>						
Wipe down Reagent Platform and ARC Bank Surfaces	<input type="checkbox"/>						
Clean Suction Cup	<input type="checkbox"/>						
<b>2-MONTHLY</b>							
Replace Suction Cup (3400 slides)	<input type="checkbox"/>						
Clean Slide Drawer Inserts, Waste Drain and Sumps, and Unload Drawer Pickup Filter*	<input type="checkbox"/>						
Clean Wash/Prime Stations*	<input type="checkbox"/>						
Clean Sump Tray*	<input type="checkbox"/>						
Clean external surfaces	<input type="checkbox"/>						
Clean Barcode Scanner (on Hood)	<input type="checkbox"/>						
<b>6-MONTHLY</b>							
Clean all bulk and waste containers	<input type="checkbox"/>						
Clean hand-held barcode scanner (on BOND Controller)	<input type="checkbox"/>						
<b>8-MONTHLY/7500 slides</b>							
Use the BOND-PRIME ARC Refresh Kit	<input type="checkbox"/>						
<b>NOTIFICATION</b>							
Use the BOND-PRIME Cleaning Kit	<input type="checkbox"/>						

\* If it is necessary, do these tasks more frequently.

For week starting \_\_\_\_\_ to \_\_\_\_\_ For month of \_\_\_\_\_

## 4.2 Refill the DI Water Container

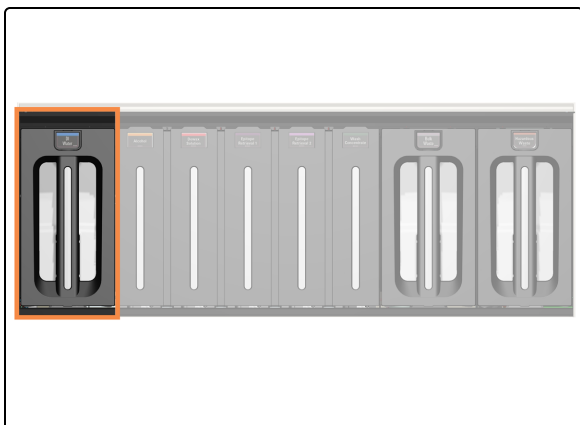

The DI Water Container is located at the left of the Bulk Containers Cabinet.

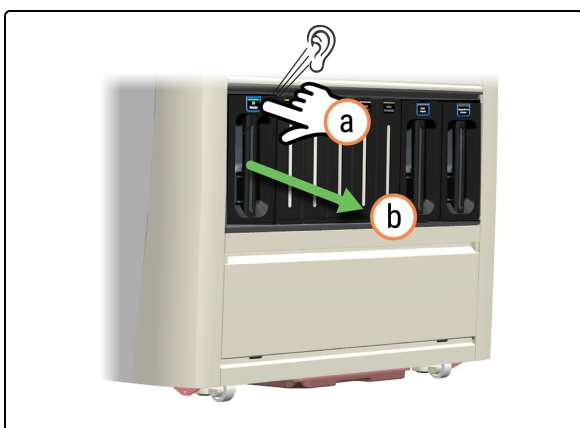

1. Remove the DI Water Container.
  - a. Press the DI Water button.
  - b. Pull the container out of the processing module.



**WARNING:** Use both hands when you lift the DI Water Container.



Return the container quickly to ensure there is DI Water available.

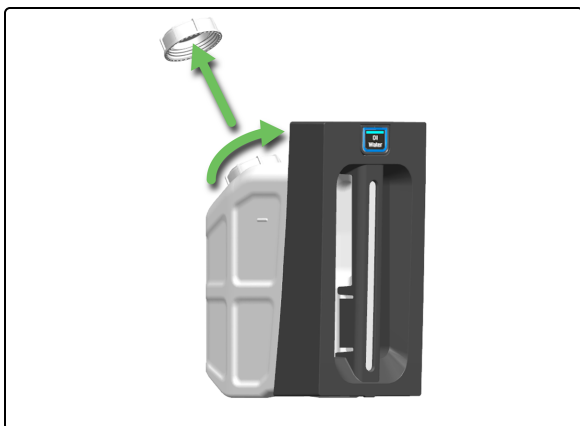

2. Remove the DI Water Container cap.

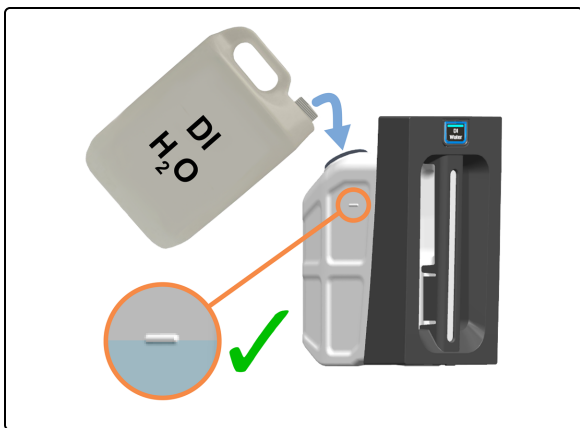

3. Pour DI Water into the container until it reaches the fill line.

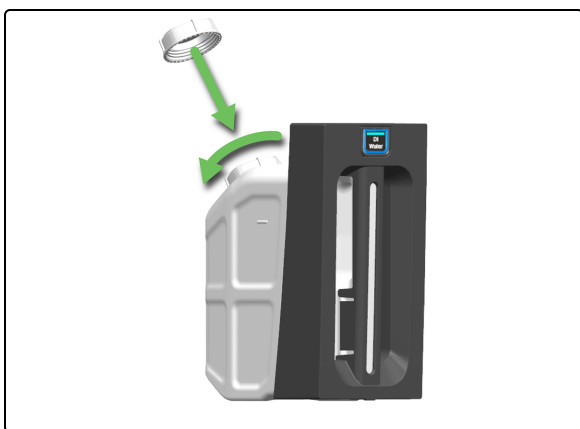

4. Put the DI Water Container cap back on.

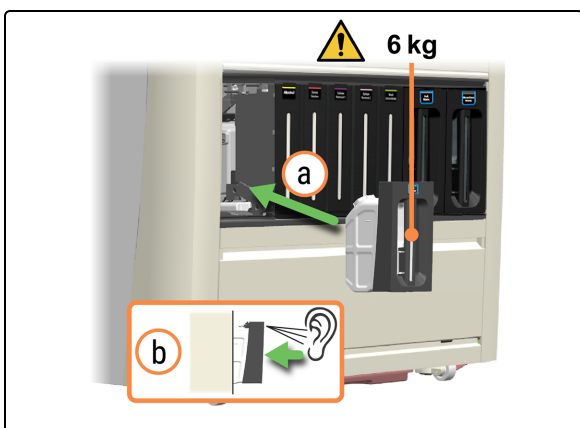

5. Reinsert the full DI Water Container.
  - a. Using two hands, reinsert the DI Water Container into the processing module.
  - b. Listen for a click sound to confirm the container is locked in place.

Make sure the container is fully inserted. Failure to do so can cause slides to be rejected in the Preload Drawer.

## 4.3 Refill the Alcohol Container



Before you start this procedure, ensure you are logged in to the processing module. Refer to [2.1 Log in and log out](#).



1. Tap **Maintenance**.

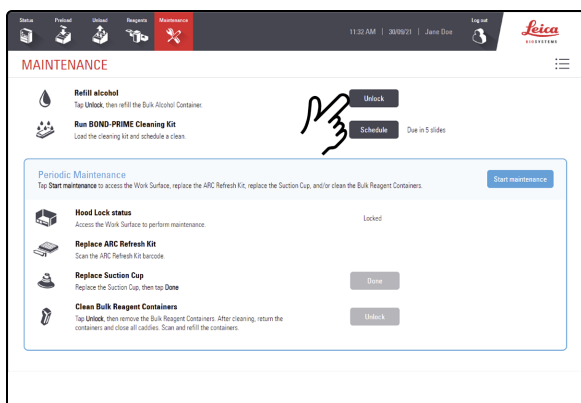

2. Tap **Unlock** next to **Refill alcohol**.

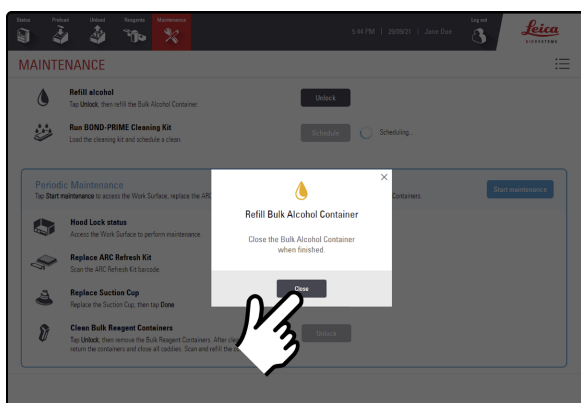

A popup window is displayed prompting you to refill the Bulk Alcohol Container.



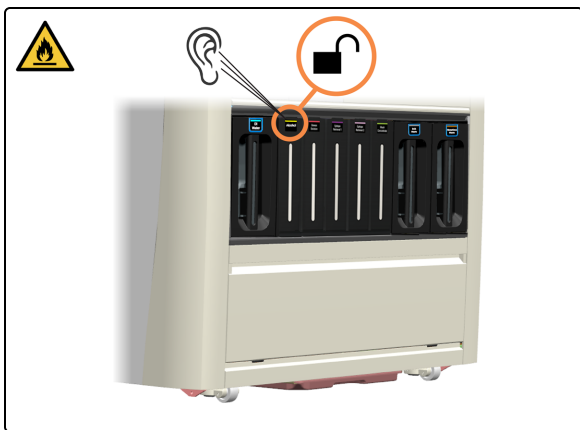

You will hear a click when the container unlocks. It will remain unlocked for only 30 seconds.



3. Pull the top of the container towards you.



4. Open the container lid.

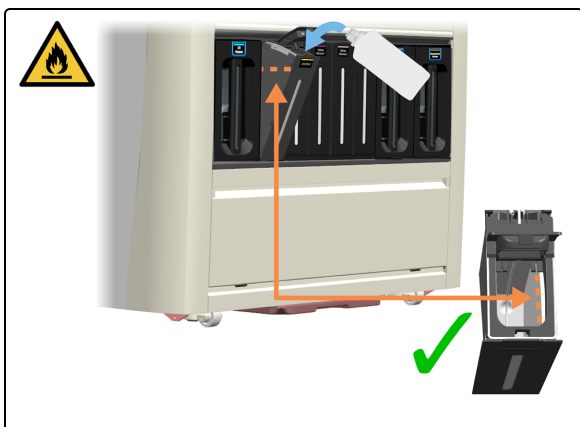

5. Pour the alcohol into the bulk container up to the maximum fill line.



6. Close the container lid.



7. Push the container into the processing module.

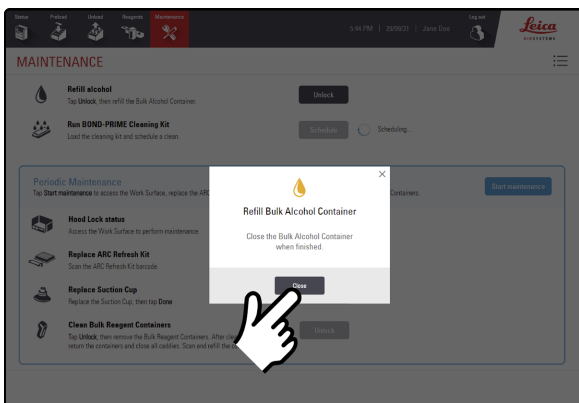

8. Tap **Close**.

## 4.4 Refill the Lot Tracked Bulk Containers



Before you start this procedure, ensure you are logged in to the processing module. Refer to [2.1 Log in and log out](#).

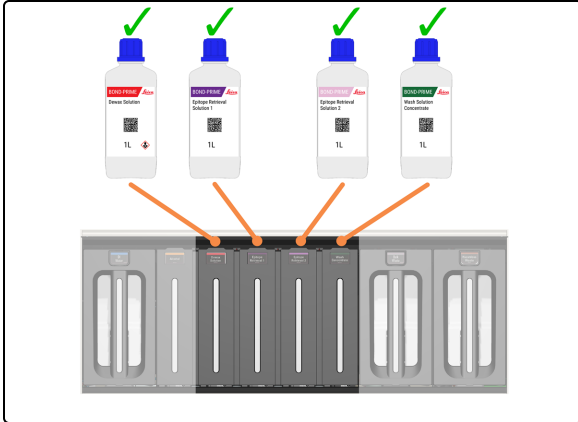

BOND-PRIME has the following Lot Tracked Bulk Containers:

- Dewax Solution
- ER1
- ER2
- Wash Concentrate

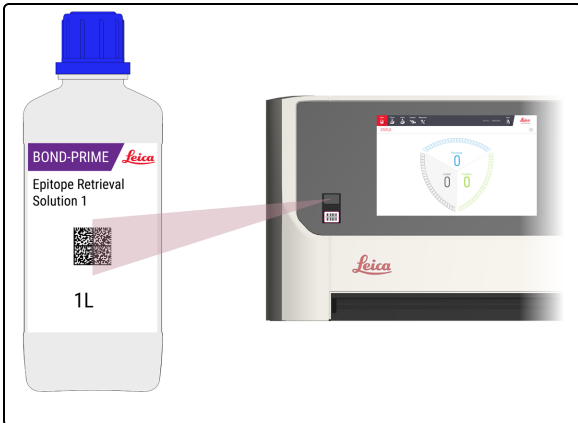

1. Scan the barcode on the supply bottle to ensure lot number tracking occurs.



To activate the laser, wave your hand in front of the scanner. You can also use the reflection of the bottle (on the Hood) to position the laser over the 2D barcode on the bottle.

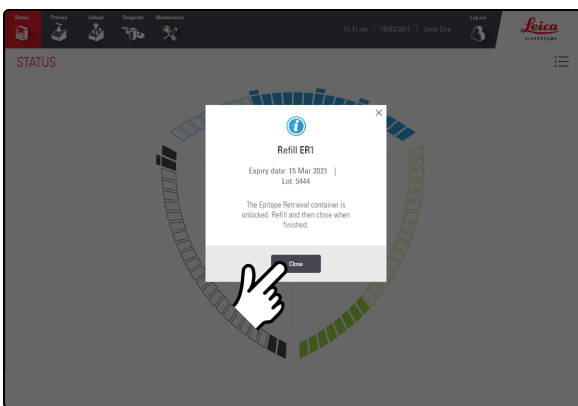

2. Tap **Close**.

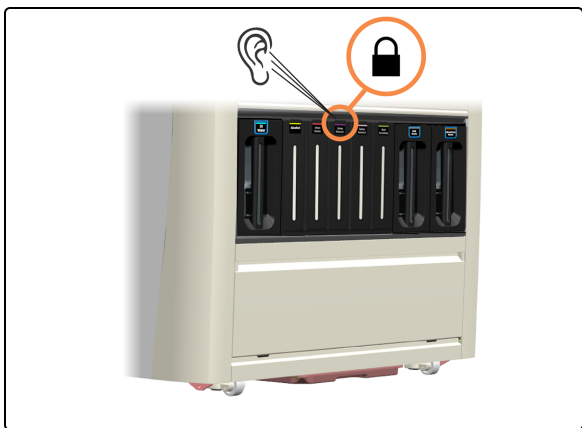

You will hear a click when the container unlocks. It will remain unlocked for only 30 seconds.



3. Pull the top of the container towards you.



4. Open the container lid.

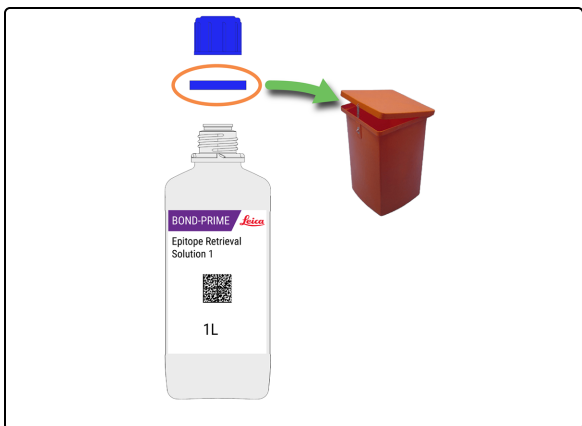

5. Open the bottle and dispose of the tamper-proof seal ring according to laboratory procedures.



- Pour the solution into the bulk containers up to the maximum fill line.



**DO NOT** dilute any reagents with water.



**WARNING:** To avoid spillage, **DO NOT** refill Bulk Reagent Containers while they are away from the processing module.



- Close the container lid.



- Push the caddy back into the processing module.

## 4.5 Empty the Waste Containers



**WARNING:** You must wear the minimum required PPE before you maintain the processing module. Refer to [General cautions](#).

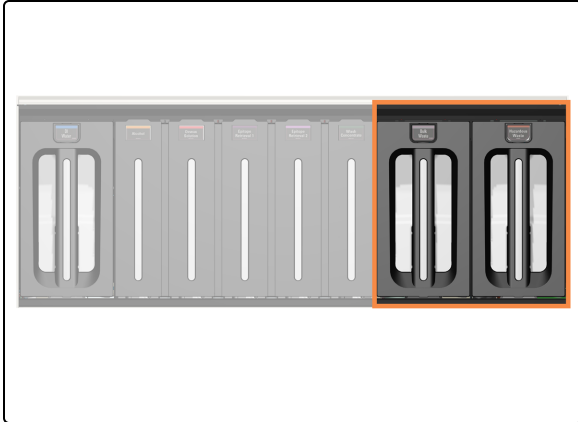

The Waste Containers are located at the right of the Bulk Container Cabinet.

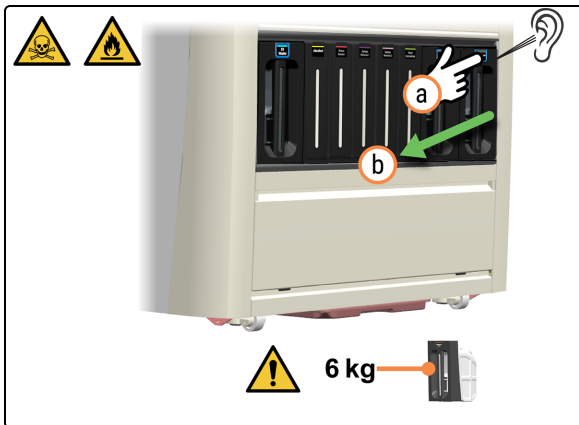

1. Remove the waste container.
  - a. Press the Waste button.
  - b. Pull the container out of the processing module.



**WARNING:** Use both hands when you lift the Waste containers.



2. Remove the Waste Container cap.

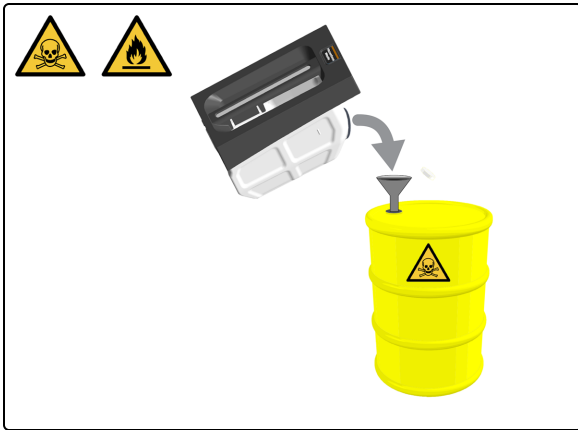

3. Empty the contents according to your laboratory procedures. Quickly return the container to the processing module to ensure there is waste capacity.



Hazardous waste example is shown.



**WARNING:** Dispose of waste in accordance with all procedures and government regulations that apply at the laboratory site.



4. Put the Waste Container cap back on.

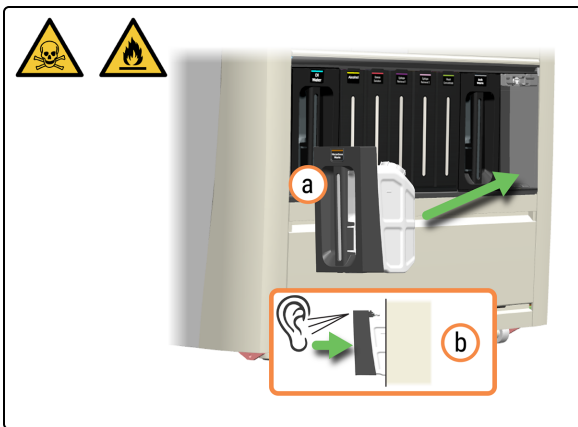

5. Reinsert the Waste Container.
  - a. Reinsert the Waste Container into the processing module.
  - b. Listen for a click sound to confirm the container is locked in place.

Make sure the container is fully inserted. Failure to do so can cause slides to be rejected in the Preload Drawer.

## 4.6 Use the BOND-PRIME Cleaning Kit

If required:

- [4.2 Refill the DI Water Container](#)
- [4.3 Refill the Alcohol Container](#)
- [4.4 Refill the Lot Tracked Bulk Containers](#)
- [4.5 Empty the Waste Containers](#)



The BOND-PRIME Cleaning Kit cannot be preemptively scheduled.



Before you start this procedure, ensure you are logged in to the processing module. Refer to [2.1 Log in and log out](#).

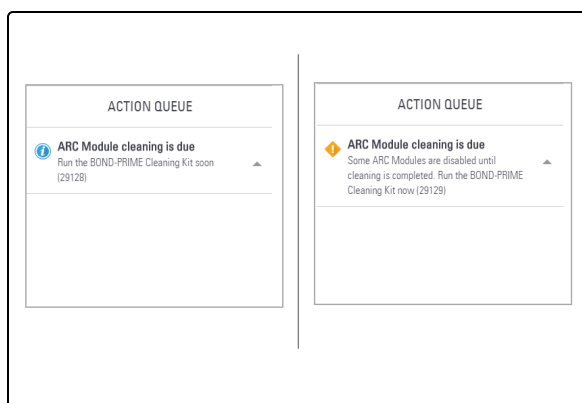

A message is displayed in the Action Queue when it is time to run the BOND-PRIME Cleaning Kit. ARC Modules must be cleaned when the usage count is between 17 and 23.

You must register the BOND-PRIME Cleaning Kit on the BOND Controller (refer to the *BOND 7 User Manual*).

Some ARC Modules are disabled until cleaning is completed.



Ensure there are no slides in the Preload Drawer and Unload Drawer when starting a clean.

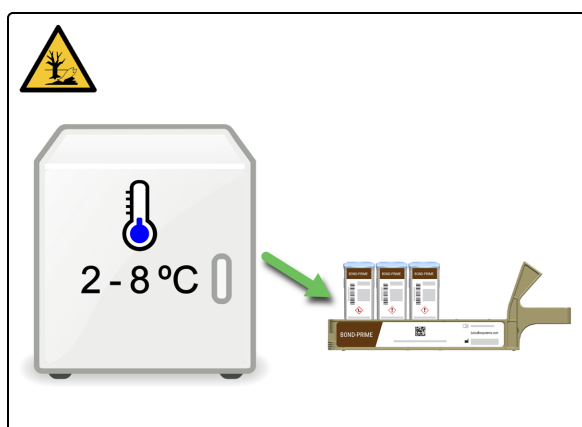

1. Retrieve the Reagent Tray containing the BOND-PRIME Cleaning Kit.



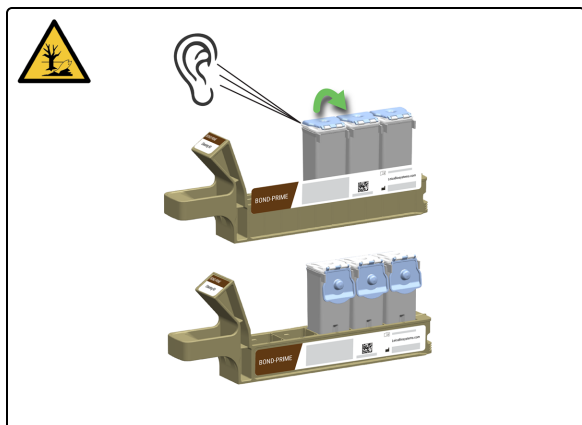

2. Open the Reagent Container Lid. You will hear a click as the lid is opened.

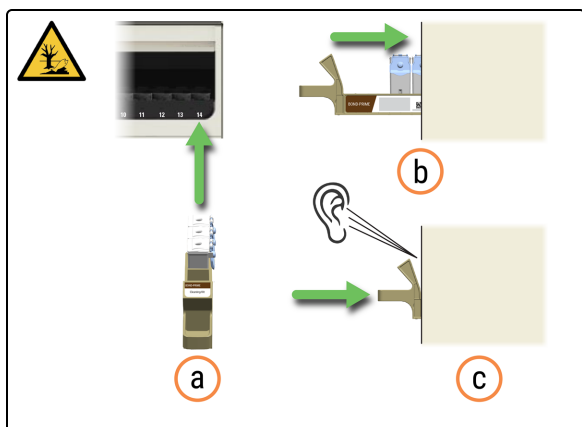

3. Insert the Reagent Tray into the processing module.
  - a. Take the Reagent Tray to the processing module.
  - b. Push the Reagent Tray into the Reagent Platform.
  - c. Listen for a click to confirm the tray is correctly inserted.



The BOND-PRIME Cleaning Kit is displayed on the Reagent screen.

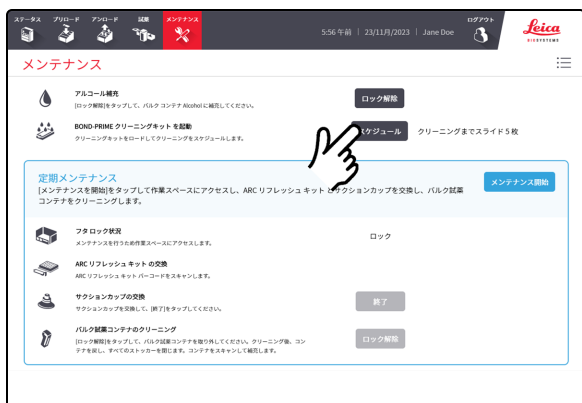

4. Tap **Schedule** next to Run BOND-PRIME Cleaning Kit.

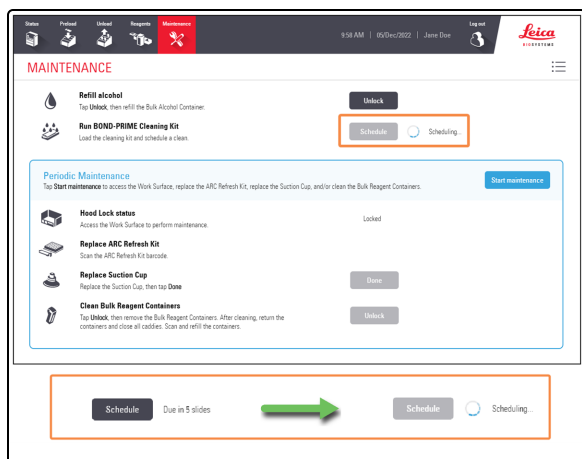

The **Schedule** button is disabled and a status icon next to the button indicates that scheduling is in progress.

You can load new slides into the Preload Drawer after the **Schedule** button becomes inactive and the spinning wheel is visible.



The time in minutes for the cleaning process to finish is displayed.

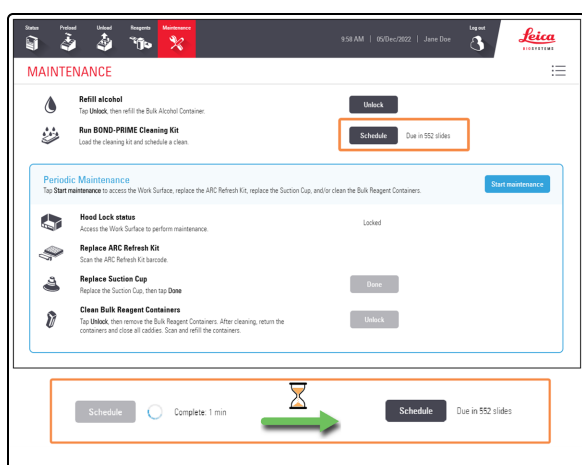

When the BOND-PRIME Cleaning Kit is completed, the **Schedule** button is enabled and the number of slides that can be processed before the kit is needed again is displayed.

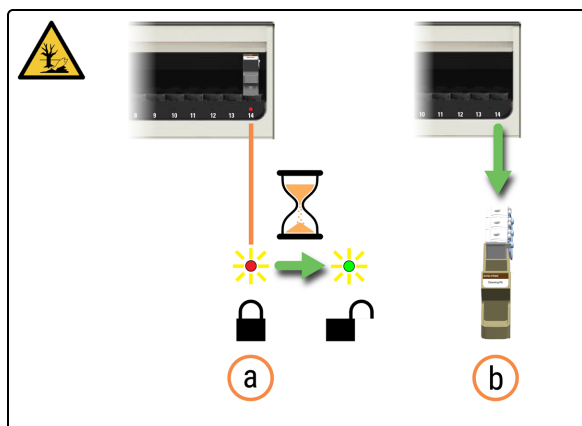

5. Remove the Reagent Tray.
  - a. Check that the Reagent Lane LED is red indicating that it is no longer in use.
  - b. Remove the Reagent Tray from the Reagent Platform.

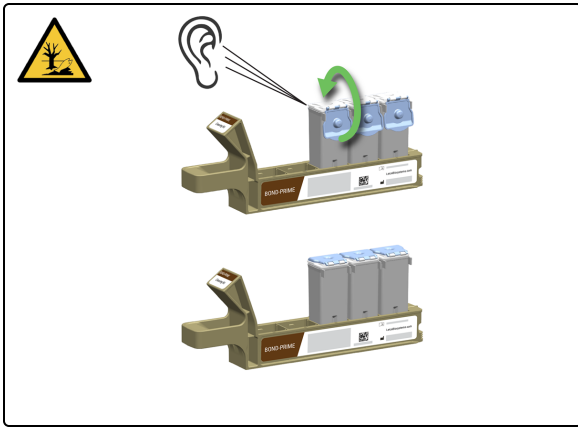

6. Close the Reagent Container Lid. You will hear a click when the lid is secured.

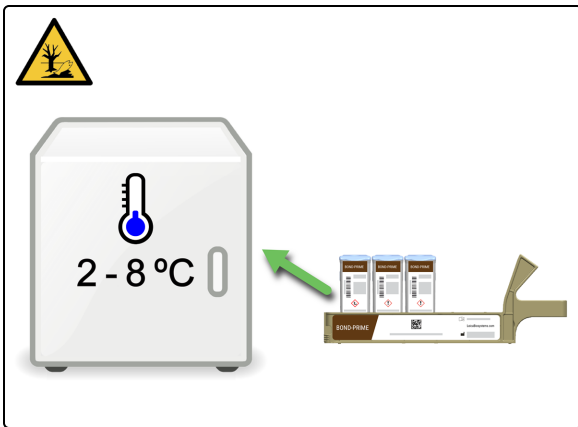

7. Store Reagent Containers between 2°C - 8°C.

## 4.7 Start Maintenance

Use the **Start maintenance** procedure to access the Work Surface, clean the Bulk Reagent Containers, replace the Suction Cup, or use the BOND-PRIME ARC Refresh Kit.



Before you start this procedure, ensure you are logged in to the processing module. Refer to [2.1 Log in and log out](#).



1. Tap **Status**.

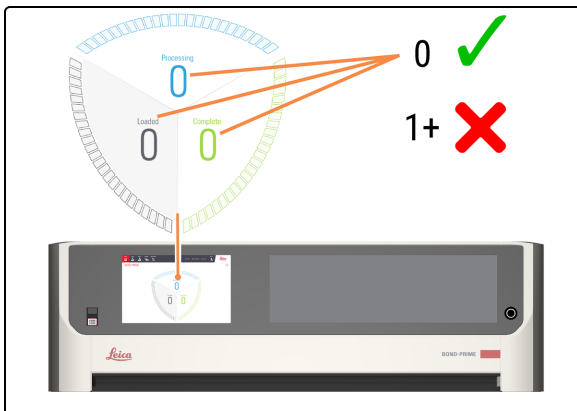

2. Check the Status screen to ensure there are:

- no slides currently being processed (Processing)
- no slides in the Preload Drawer (Loaded) and Unload Drawer (Complete).

Refer to [2.3 Status Screen](#).



3. Tap **Maintenance**.

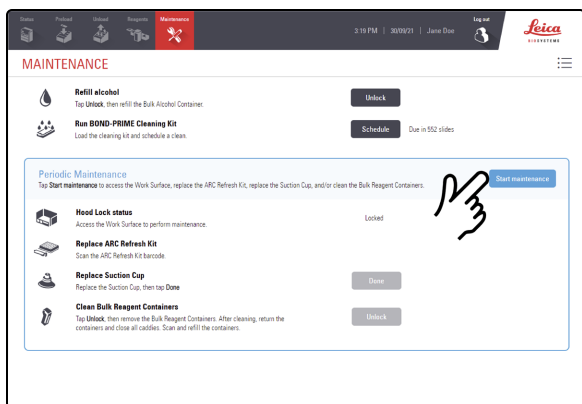

4. Tap **Start Maintenance**.

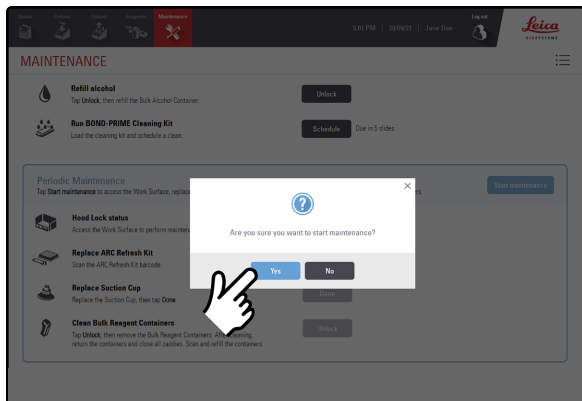

5. Tap **Yes**.

There is a wait time after tapping **Yes** while the processing module is preparing the Work Surface for maintenance and unlocking the Hood.



When maintenance is started, the processing module automatically opens all ARC Modules.

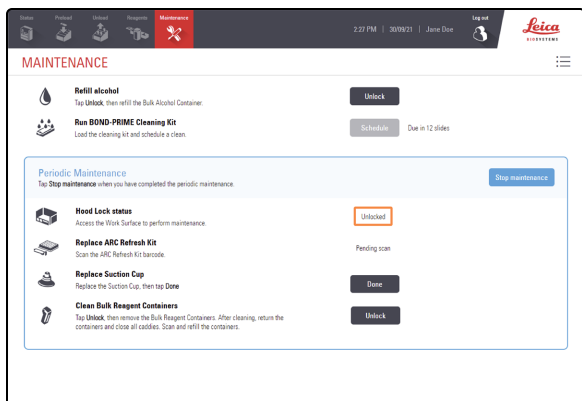

When the Hood is unlocked, the **Hood Lock Status** on the Maintenance screen changes to **Unlocked**.

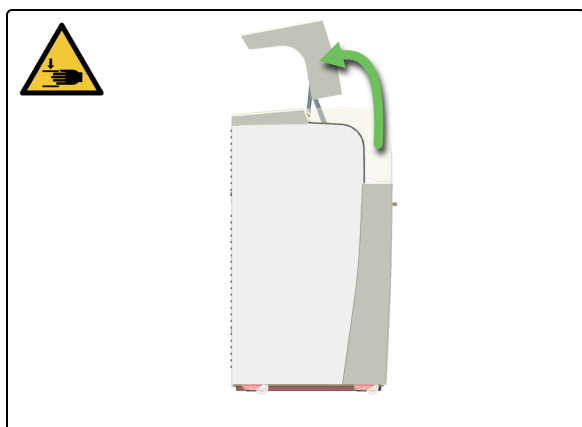

6. Open the Hood.

## 4.8 Wipe internal surface of ARC Modules



**WARNING:** You must wear the minimum required PPE before you maintain the processing module. Refer to [General cautions](#).



1. Tap **Status**.

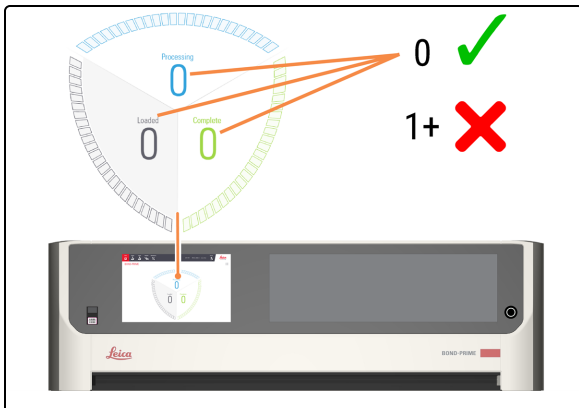

2. Check the Status screen to ensure there are:

- no slides currently being processed (Processing)
- no slides in the Preload Drawer (Loaded) and Unload Drawer (Complete).

Refer to [2.3 Status Screen](#).



3. Tap **Maintenance**.

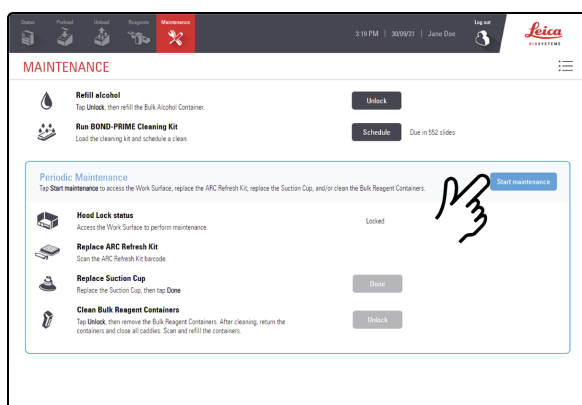

4. Tap **Start Maintenance**.

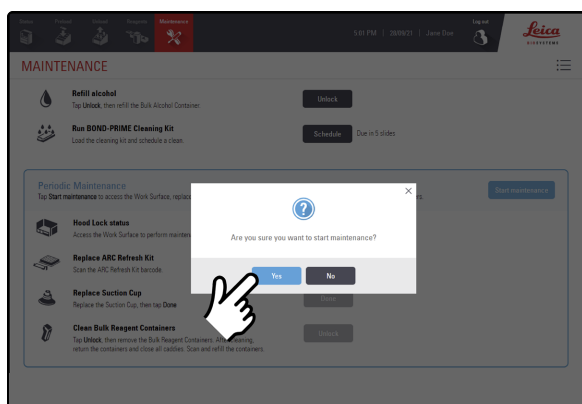

5. Tap **Yes**.

There is a wait time after tapping **Yes** while the processing module is preparing the Work Surface for maintenance and unlocking the Hood.



When maintenance is started, the processing module automatically opens all ARC Modules.

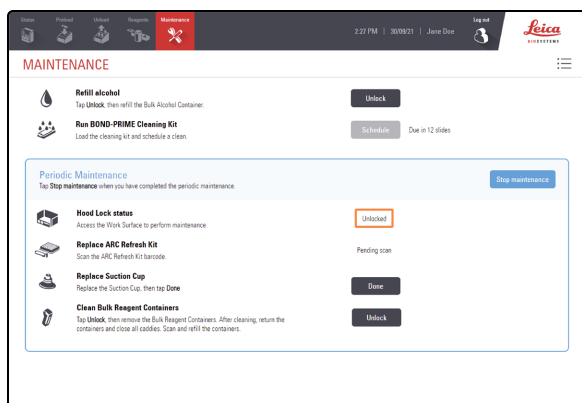

When the Hood is unlocked, the **Hood Lock Status** on the Maintenance screen changes to **Unlocked**.

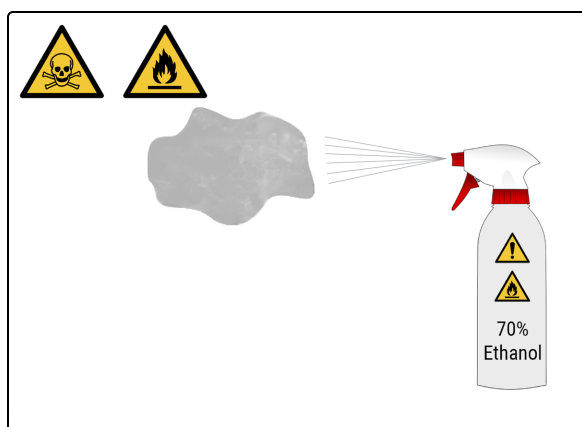

6. Moisten a clean lint-free cloth with 70% ethanol solution.

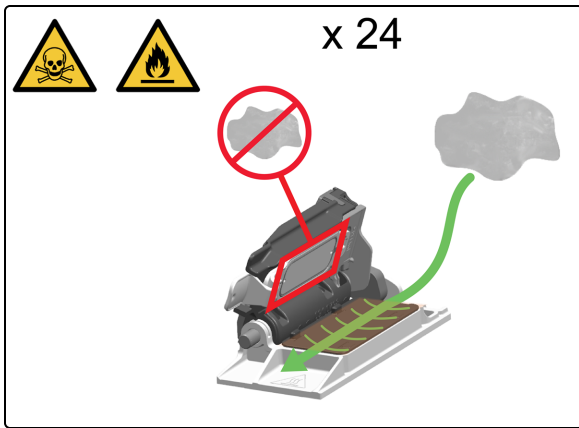

Wipe the ARC Module from the rear to the front to remove any particles or residue. Do not wipe the Covertile, as this may damage the Covertile Seal.

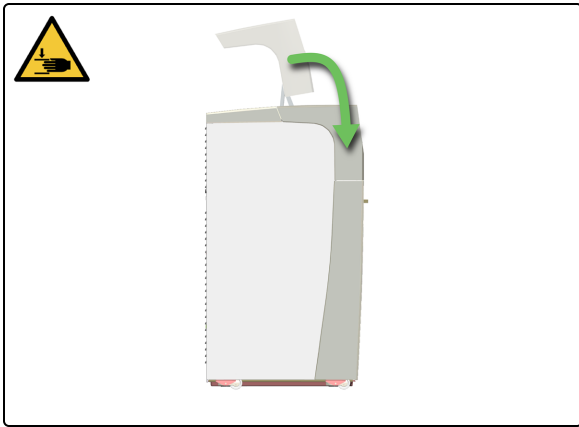

- If you no longer require access to the Work Surface, close the Hood and then continue with this procedure.

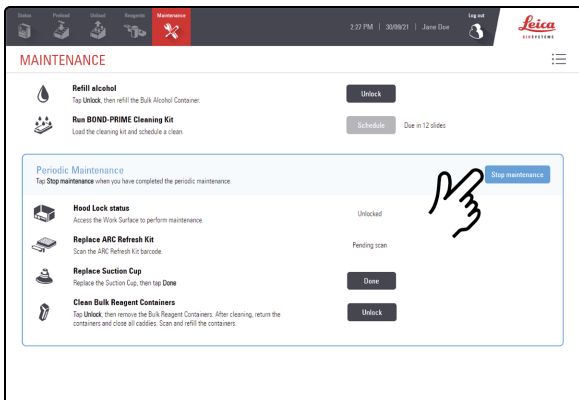

- Tap **Stop maintenance**.

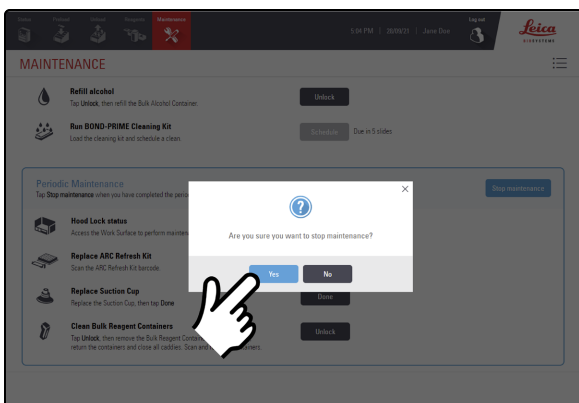

- Tap **Yes**.



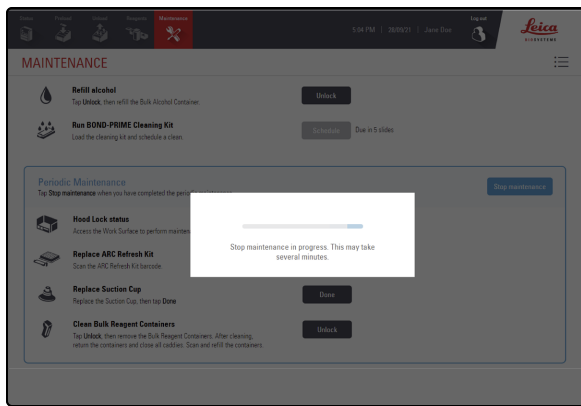

There is a wait time while the processing module is preparing to return to clinical operation.

The processing module automatically closes the ARC Modules and locks the Hood when you stop maintenance.

## 4.9 Wipe down Reagent Platform and ARC Bank Surfaces



**WARNING:** You must wear the minimum required PPE before you maintain the processing module. Refer to [General cautions](#).



1. Tap **Status**.

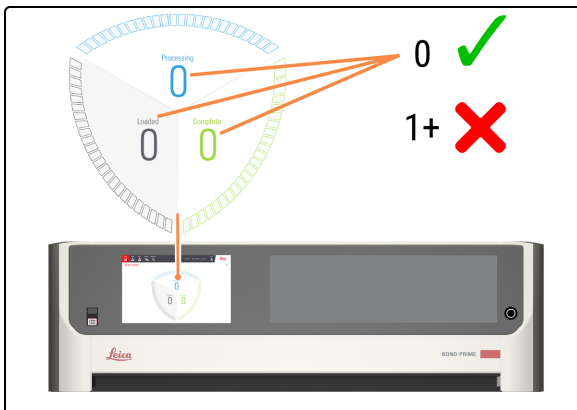

2. Check the Status screen to ensure there are:

- no slides currently being processed (Processing)
- no slides in the Preload Drawer (Loaded) and Unload Drawer (Complete).

Refer to [2.3 Status Screen](#).

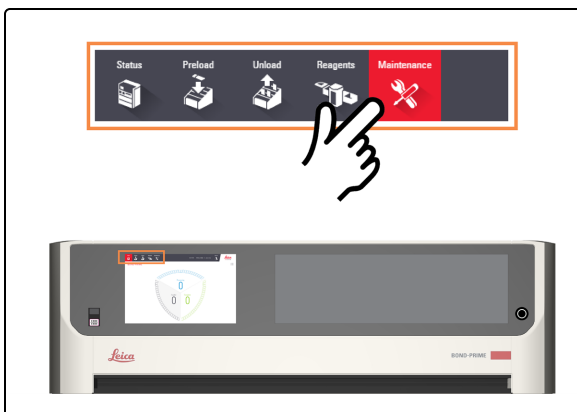

3. Tap **Maintenance**.

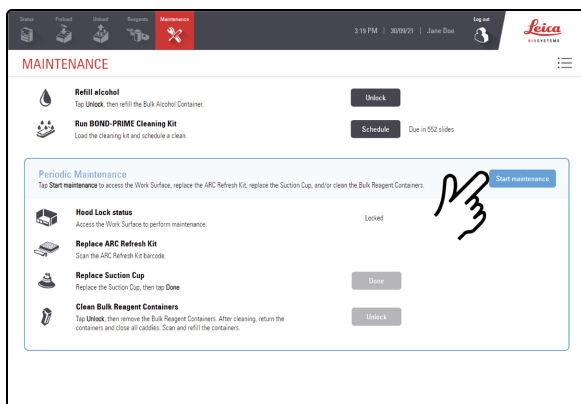

4. Tap **Start Maintenance**.

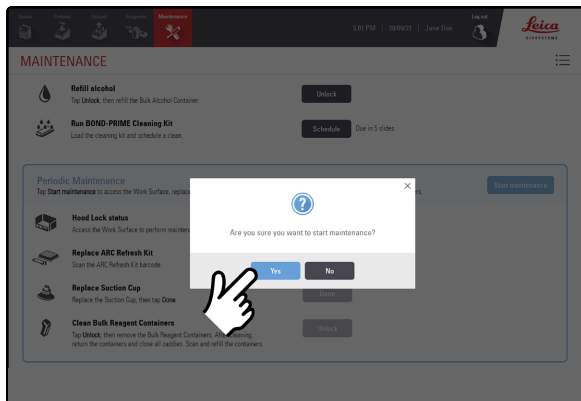

5. Tap **Yes**.

There is a wait time after tapping **Yes** while the processing module is preparing the Work Surface for maintenance and unlocking the Hood.



When maintenance is started, the processing module automatically opens all ARC Modules.



When the Hood is unlocked, the **Hood Lock Status** on the Maintenance screen changes to **Unlocked**.

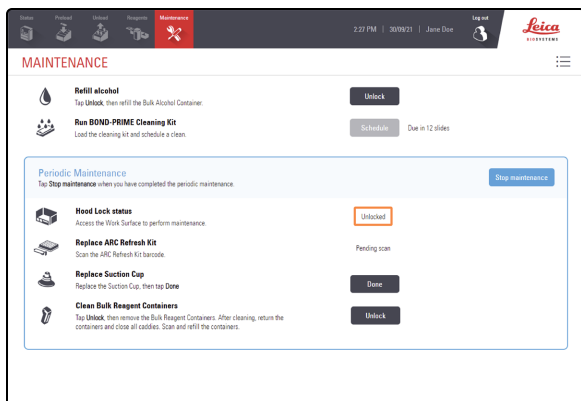

6. Remove all reagent trays from the Reagent Platform.

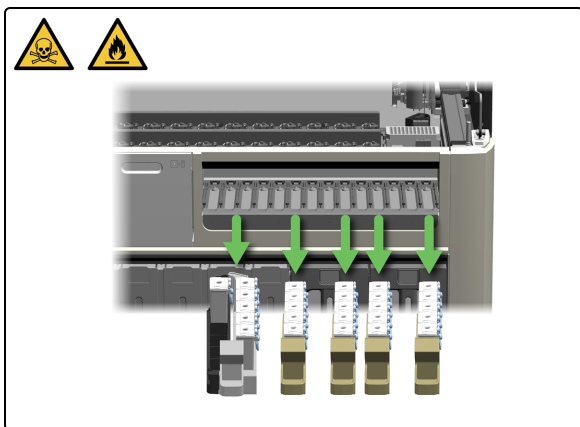

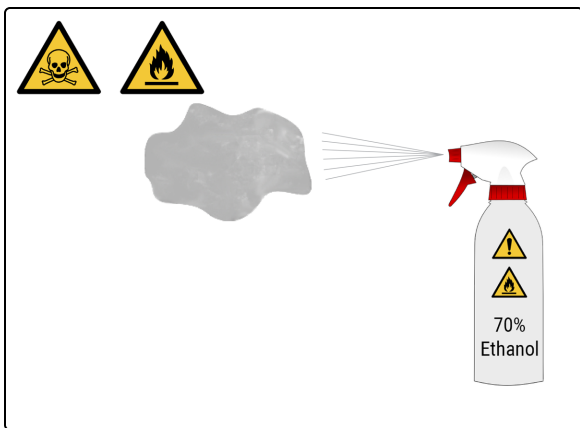

7. Moisten a clean lint-free cloth with 70% ethanol solution.

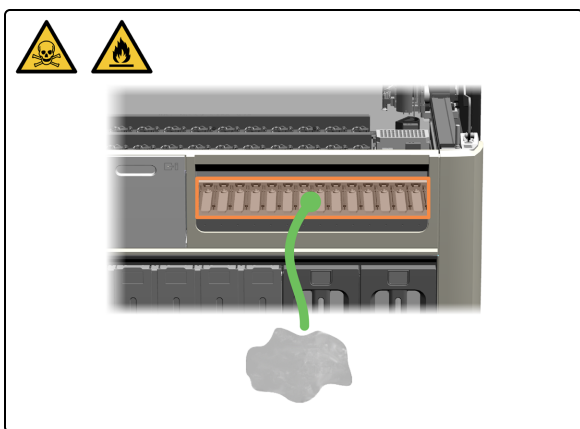

8. Wipe the surface of each lane on the Reagent Platform with the lint-free cloth.

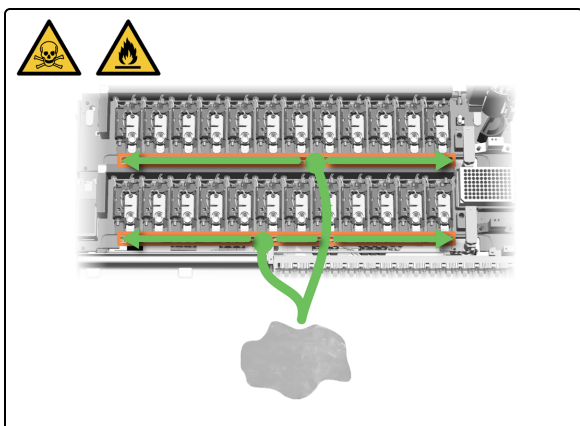

9. Wipe both Wash Robot rails.

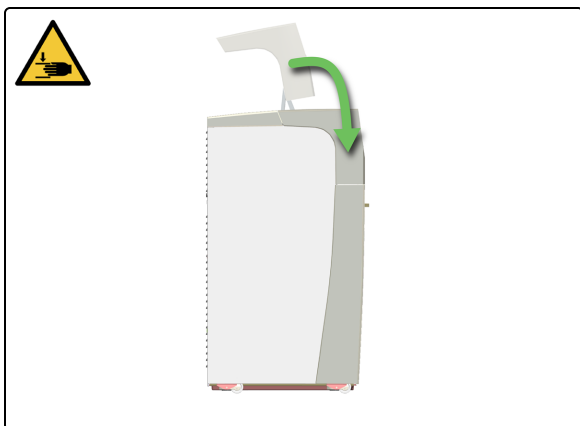

10. If you no longer require access to the Work Surface, close the Hood and then continue with this procedure.

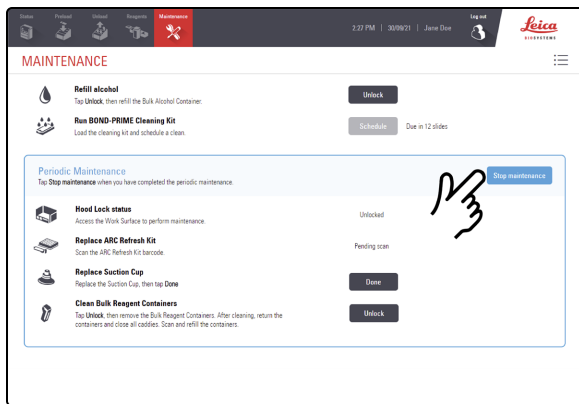

11. Tap **Stop maintenance**.

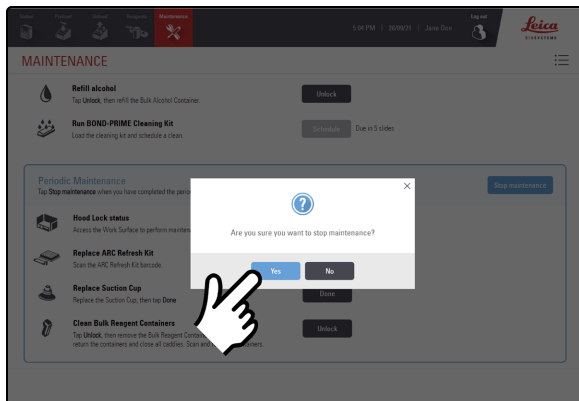

12. Tap **Yes**.

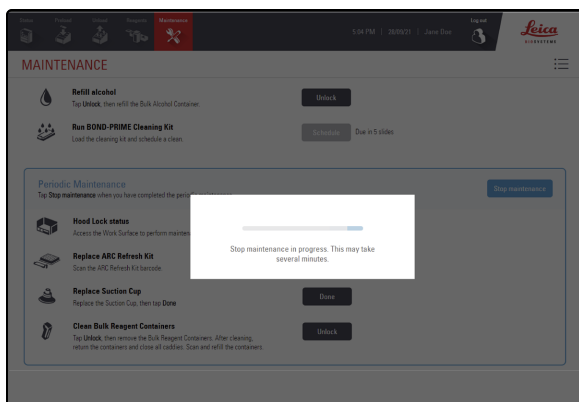

There is a wait time while the processing module is preparing to return to clinical operation.

The processing module automatically closes the ARC Modules and locks the Hood when you stop maintenance.

## 4.10 Clean the Suction Cup



**WARNING:** You must wear the minimum required PPE before you maintain the processing module. Refer to [General cautions](#).



Before you start this procedure, ensure you are logged in to the processing module. Refer to [2.1 Log in and log out](#).



1. Tap **Status**.

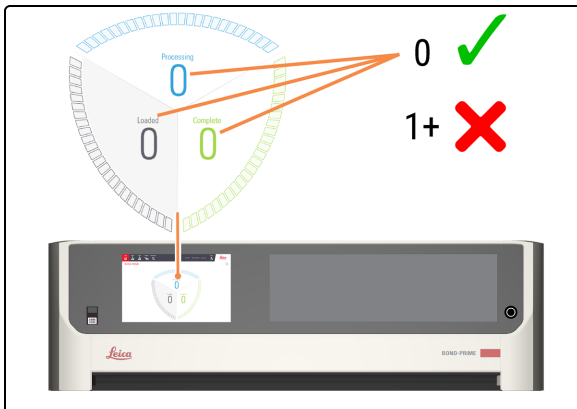

2. Check the Status screen to ensure there are:

- no slides currently being processed (Processing)
- no slides in the Preload Drawer (Loaded) and Unload Drawer (Complete).

Refer to [2.3 Status Screen](#).



3. Tap **Maintenance**.

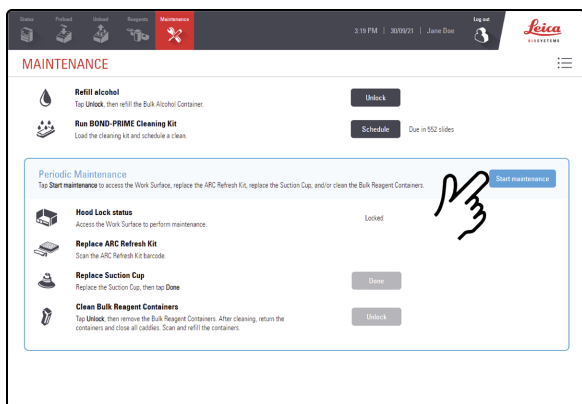

4. Tap **Start Maintenance**.

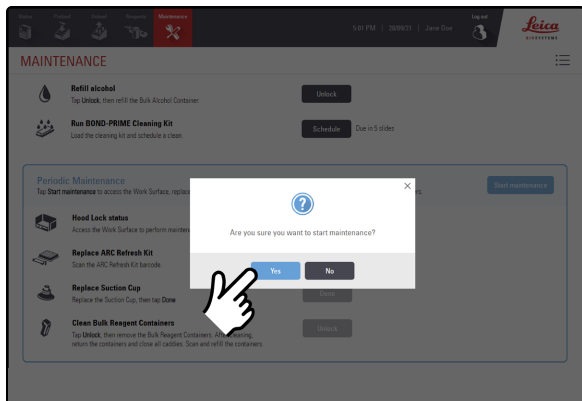

5. Tap **Yes**.

There is a wait time after tapping **Yes** while the processing module is preparing the Work Surface for maintenance and unlocking the Hood.



When maintenance is started, the processing module automatically opens all ARC Modules.



When the Hood is unlocked, the **Hood Lock Status** on the Maintenance screen changes to **Unlocked**.

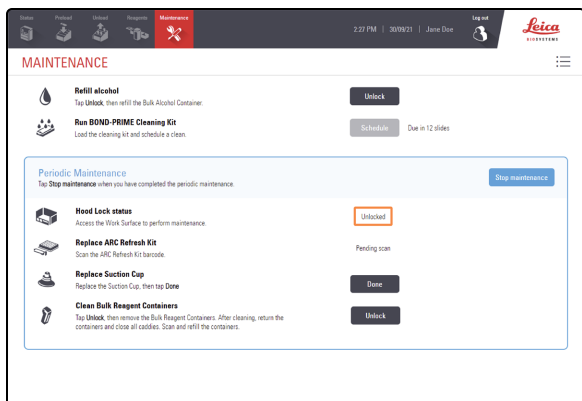

6. Locate the Suction Cup on the Robot Head.

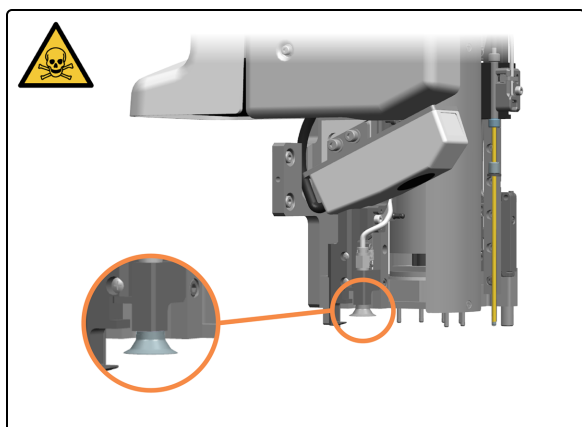

**CAUTION:** To help prevent dropping the Suction Cup into the processing module, carefully move the High-Speed Robot over the Reagent Platform.

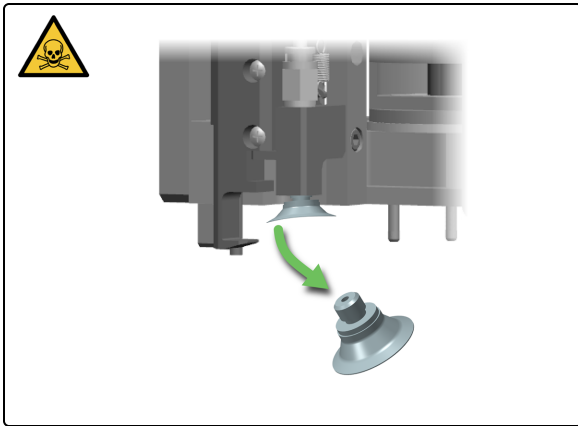

7. Remove the Suction Cup from the Robot Head.

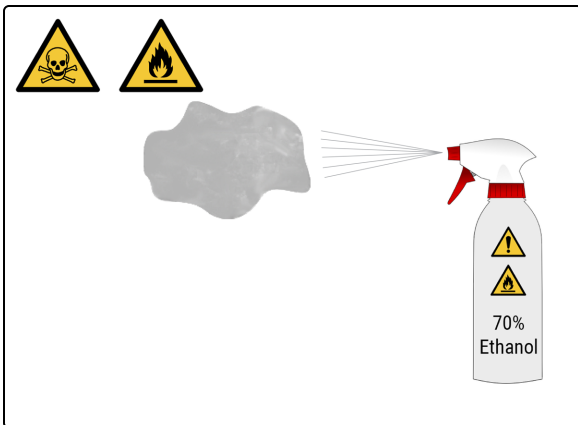

8. Moisten a clean lint-free cloth with 70% ethanol solution.

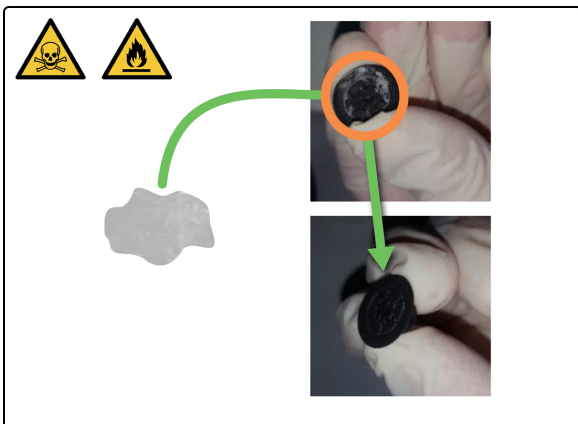

9. Flex the Suction Cup to remove residual wax, then clean with the lint-free cloth until no wax residue remains. Ensure the small hole is clear of any blockages.

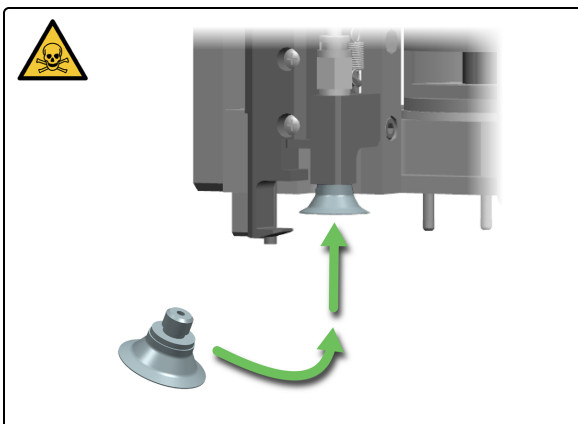

10. Refit the Suction Cup onto the Robot Head.



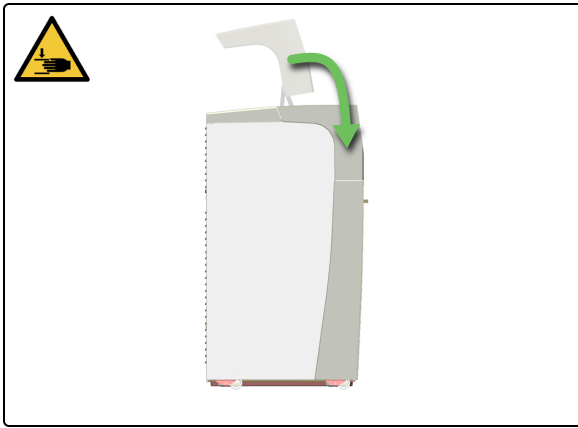

11. If you no longer require access to the Work Surface, close the Hood and then continue with this procedure.

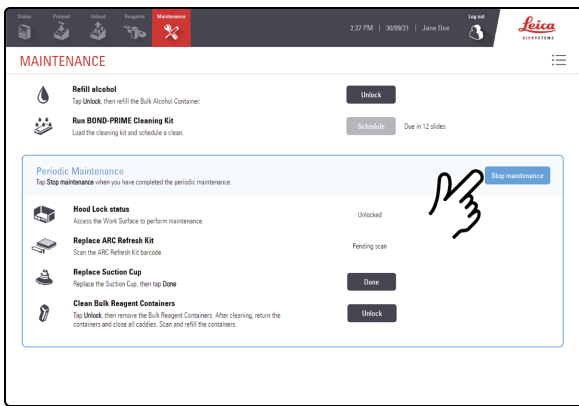

12. Tap **Stop maintenance**.

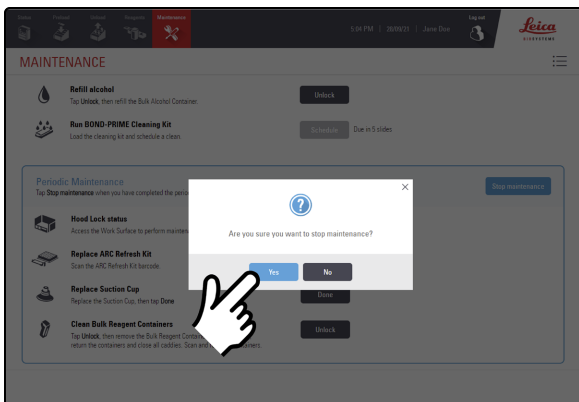

13. Tap **Yes**.

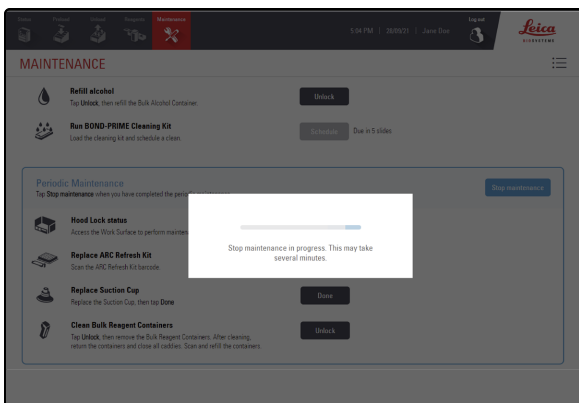

There is a wait time while the processing module is preparing to return to clinical operation.

The processing module automatically closes the ARC Modules and locks the Hood when you stop maintenance.

## 4.11 Replace the Suction Cup

Replace the Suction Cup every 3400 slides or 2 months, whichever comes first.

To help prevent dropping the Suction Cup into the processing module, carefully move the High-Speed Robot over the Reagent Platform.



**WARNING:** You must wear the minimum required PPE before you maintain the processing module. Refer to [General cautions](#).



Before you start this procedure, ensure you are logged in to the processing module. Refer to [2.1 Log in and log out](#).



1. Tap **Status**.

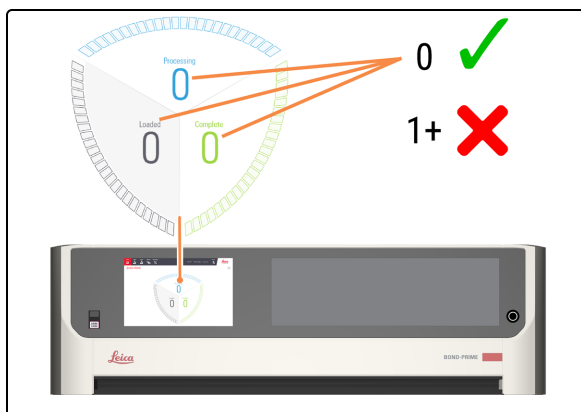

2. Check the Status screen to ensure there are:

- no slides currently being processed (Processing)
- no slides in the Preload Drawer (Loaded) and Unload Drawer (Complete).

Refer to [2.3 Status Screen](#).



3. Tap **Maintenance**.

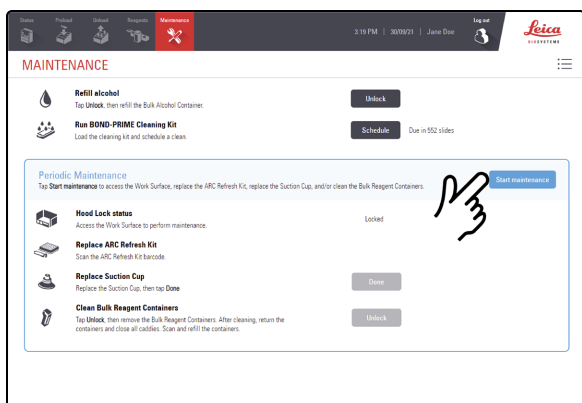

4. Tap **Start Maintenance**.

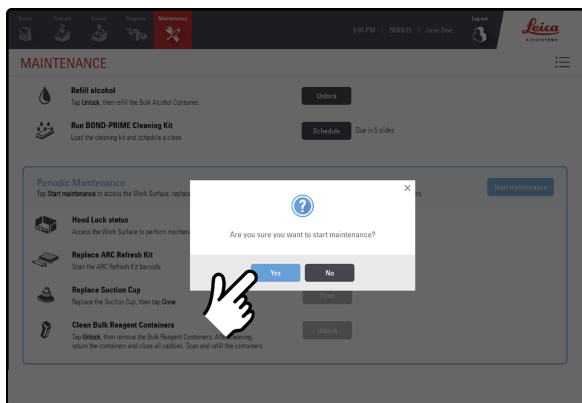

5. Tap **Yes**.

There is a wait time after tapping **Yes** while the processing module is preparing the Work Surface for maintenance and unlocking the Hood.



When maintenance is started, the processing module automatically opens all ARC Modules.



When the Hood is unlocked, the **Hood Lock Status** on the Maintenance screen changes to **Unlocked**.

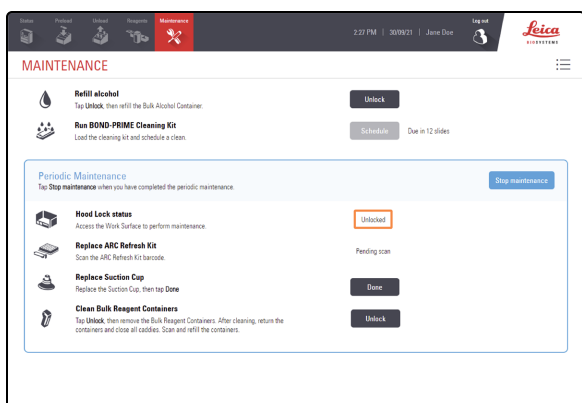

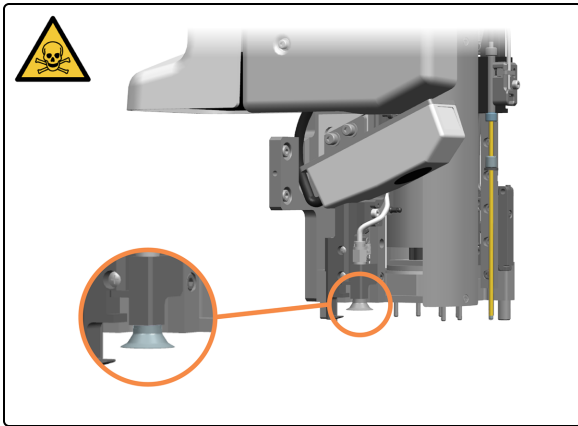

6. Locate the Suction Cup.

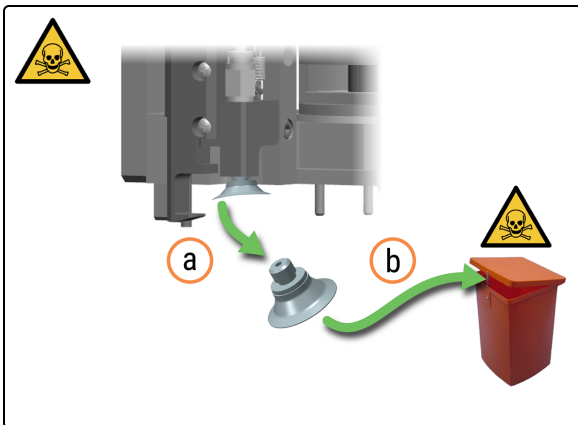

7. Remove the Suction Cup.

- a. Detach the Suction Cup from the Robot Head.
- b. Dispose of the Suction Cup according to laboratory procedures.

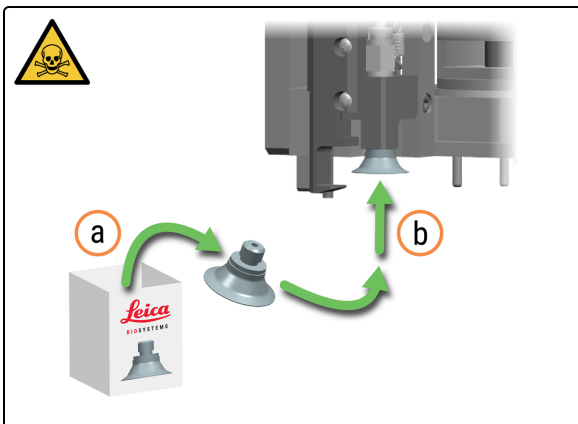

8. Install a new Suction Cup.

- a. Remove the Suction Cup from its packaging.
- b. Attach the Suction Cup to the Robot Head.

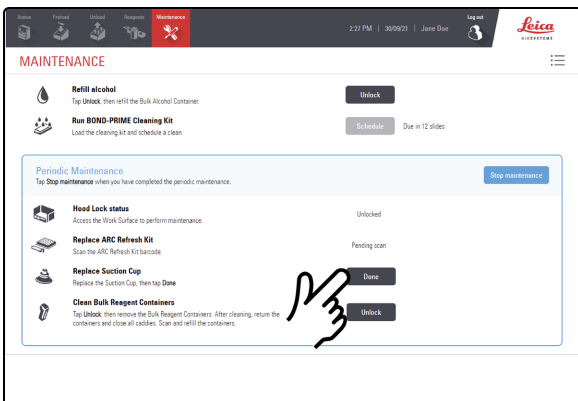

9. Tap **Done** next to **Replace Suction Cup**.

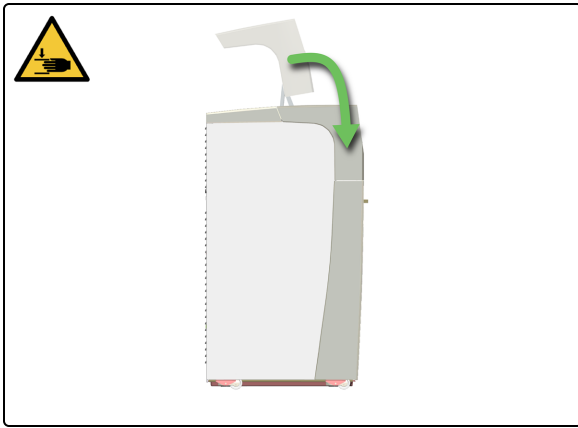

- If you no longer require access to the Work Surface, close the Hood and then continue with this procedure.

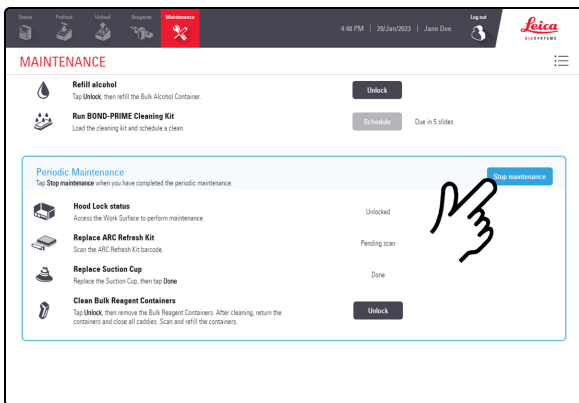

- Tap **Stop maintenance**.

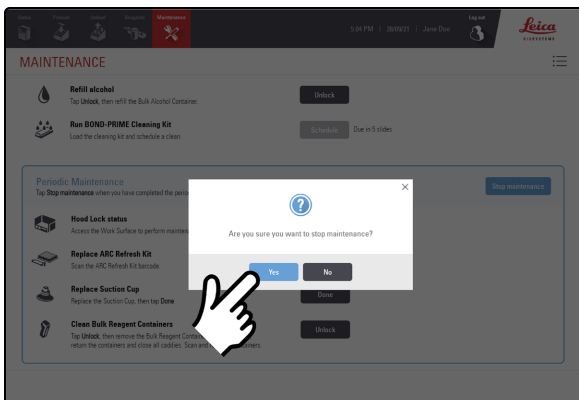

- Tap **Yes**.

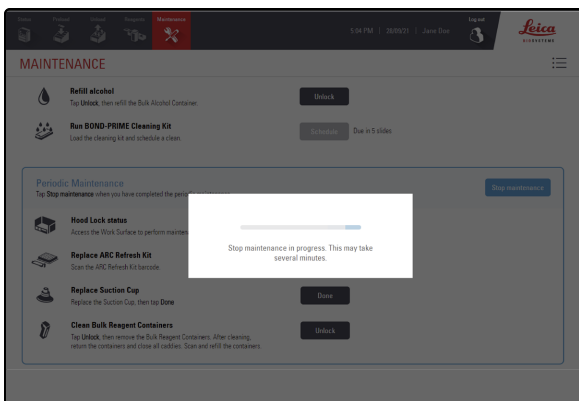

There is a wait time while the processing module is preparing to return to clinical operation.

The processing module automatically closes the ARC Modules and locks the Hood when you stop maintenance.

## 4.12 Clean the Slide Drawer Inserts, Waste Drains and Sumps, and Pickup Filter



**WARNING:** You must wear the minimum required PPE before you maintain the processing module. Refer to [General cautions](#).



Before you start this procedure, ensure you are logged in to the processing module. Refer to [2.1 Log in and log out](#).

### Clean the Slide Drawer Inserts



1. Tap **Status**.

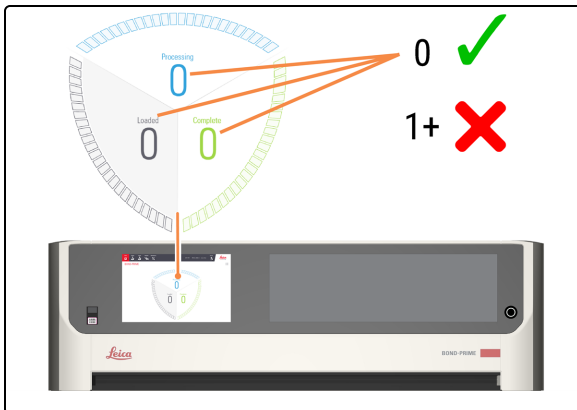

2. Check the Status screen to ensure there are:

- no slides currently being processed (Processing)
- no slides in the Preload Drawer (Loaded) and Unload Drawer (Complete).

Refer to [2.3 Status Screen](#).



3. Tap **Maintenance**.

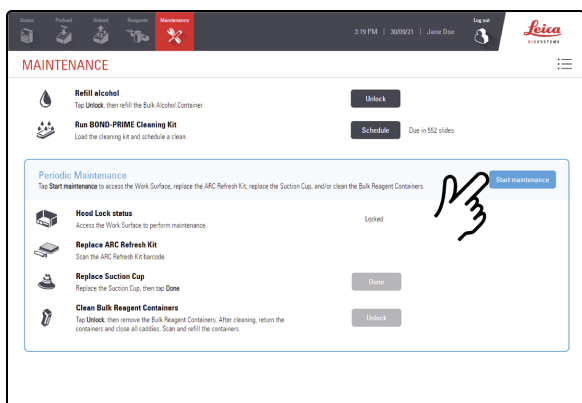

4. Tap **Start Maintenance**.

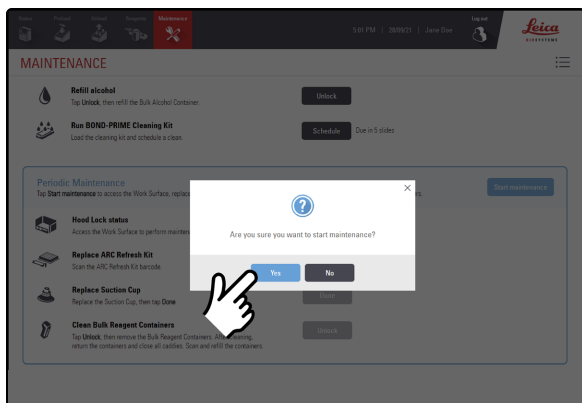

5. Tap **Yes**.

There is a wait time after tapping **Yes** while the processing module is preparing the Work Surface for maintenance and unlocking the Hood.



When maintenance is started, the processing module automatically opens all ARC Modules.



When the Hood is unlocked, the **Hood Lock Status** on the Maintenance screen changes to **Unlocked**.

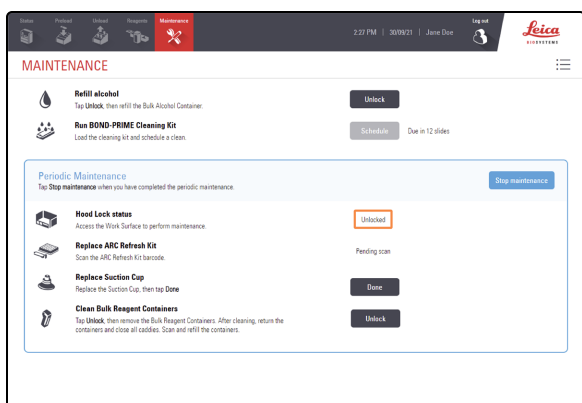

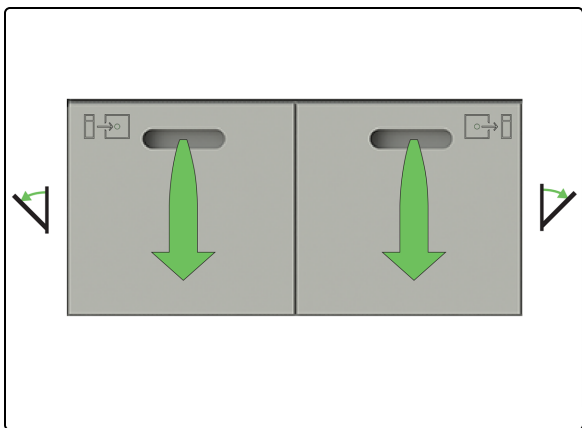

6. Open the Preload and Unload Drawers.

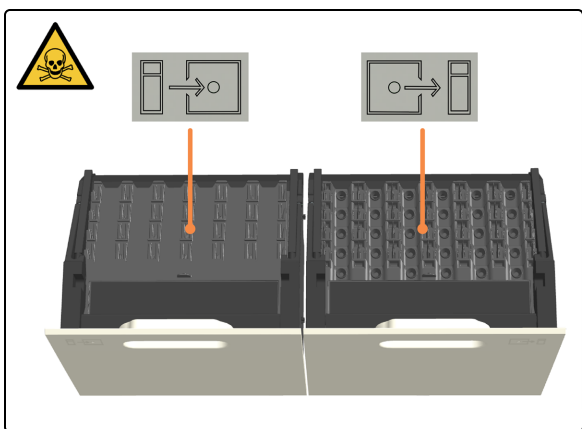

The Slide Drawer Inserts are accessible.

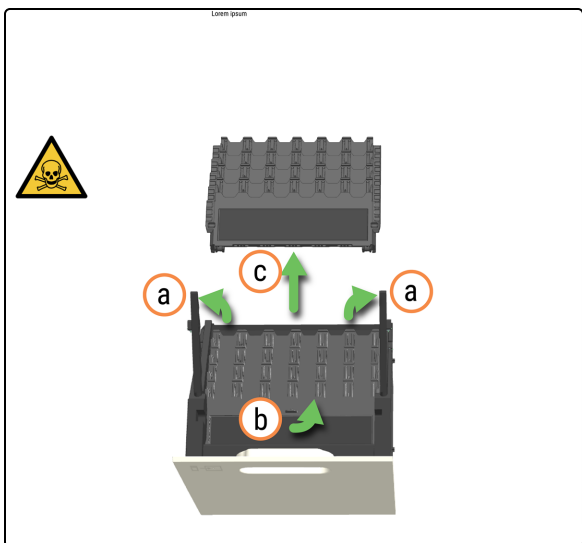

7. Remove the Slide Drawer Inserts from the Preload Drawer.

- a. Pull the locking arms up.
- b. Use the finger tab on the front fascia to assist in lifting the insert out of the drawer.
- c. Remove the Slide Drawer Insert from the Preload Drawer.



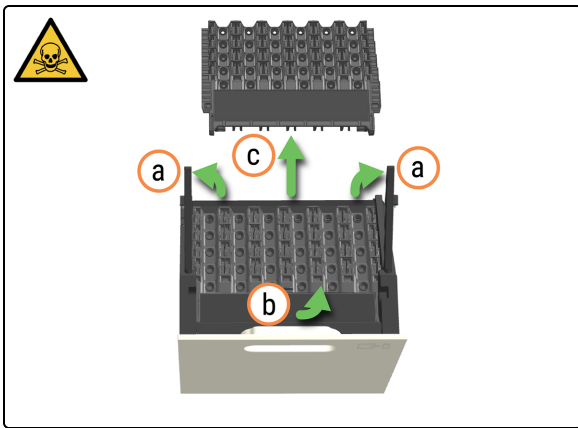

8. Remove the Slide Drawer Insert from the Unload Drawer.
  - a. Pull the locking arms up.
  - b. Use the finger tab available on the front fascia to assist in lifting the insert out of the drawer.
  - c. Remove the Slide Drawer Insert from the Unload Drawer.

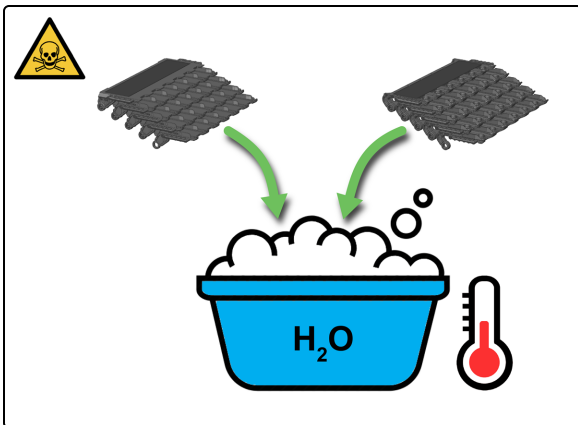

9. Wash inserts with warm soapy water.

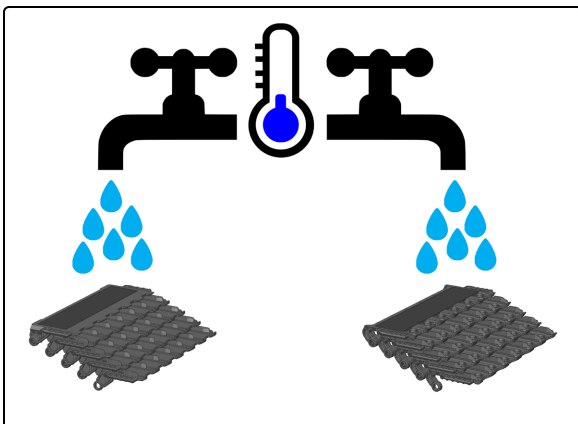

10. Rinse well with running water.

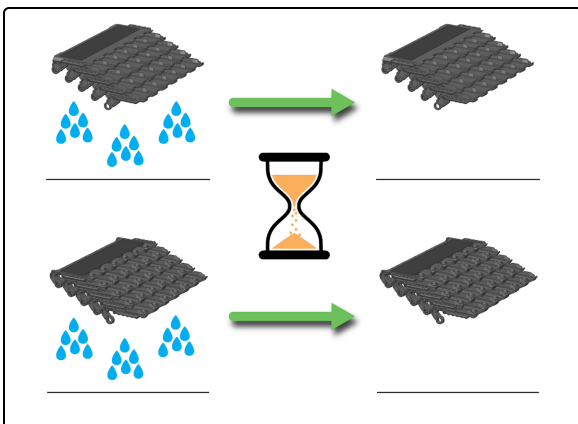

11. Allow to dry completely before re-installation in the same processing module.

# Clean the Waste Drains and Sump

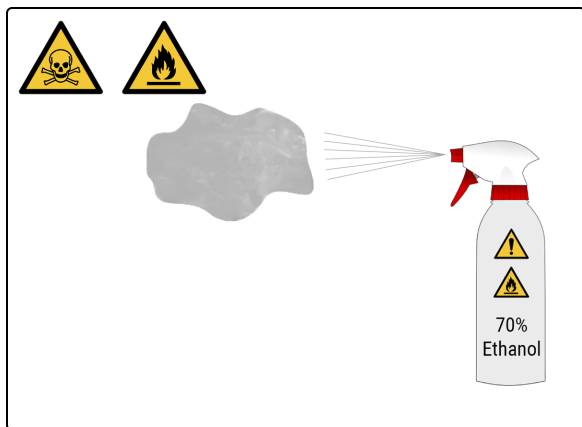

12. Moisten a clean lint-free cloth with 70% ethanol solution.

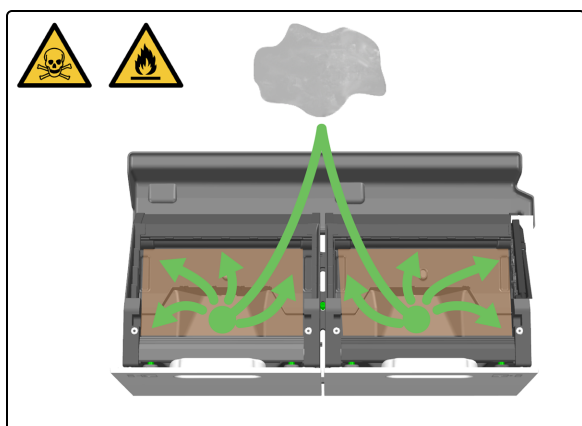

13. Wipe the Waste Drains with the lint-free cloth. The Waste Drains are accessible when the Slide Drawer Inserts have been removed from the opened drawers.

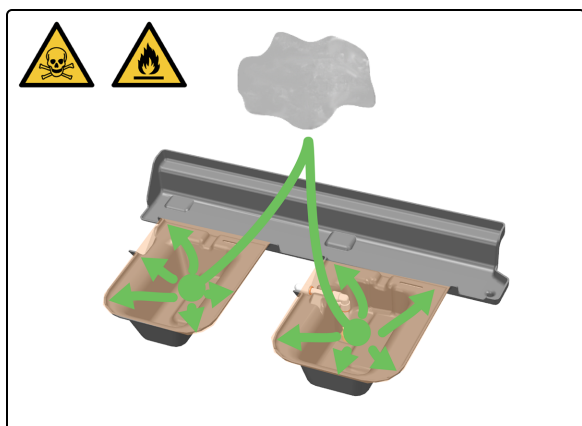

14. Wipe the Sumps with the lint-free cloth. The Sumps are located under and behind the Preload and Unload Drawers. They are accessible via the Work Surface after fully opening the drawers.

# Clean the Pickup Tube and Filter

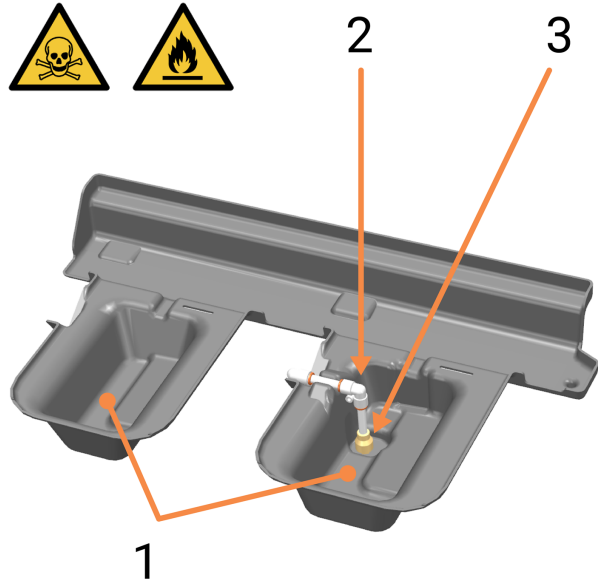

- 1 Sumps
- 2 Unload Drawer Pickup Tube
- 3 Pickup Filter



15. Rotate the Pickup Tube with Filter at elbow.



16. Press the orange sleeve to remove the Pickup Tube and Filter.

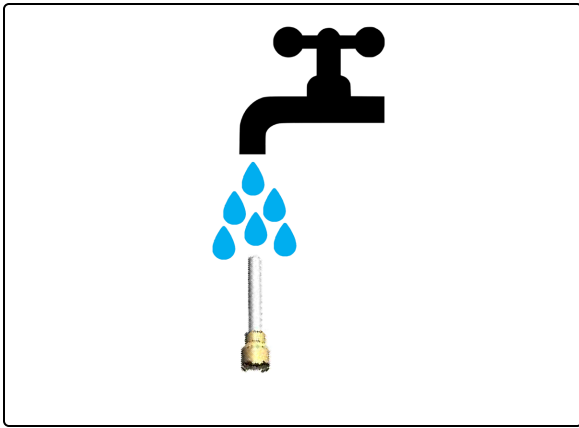

17. Flush Pickup Tube and Filter using clean water if required.



18. Confirm the Filter is free of debris.



19. Refit the Pickup Tube with Filter into the orange sleeve, making sure you push it in all the way.



20. Rotate the Pickup Tube with Filter to the original position.  
Ensure the Pickup Tube is fitted correctly to ensure it does not interfere with the alignment of the Slide Drawer Insert for the Unload Drawer.

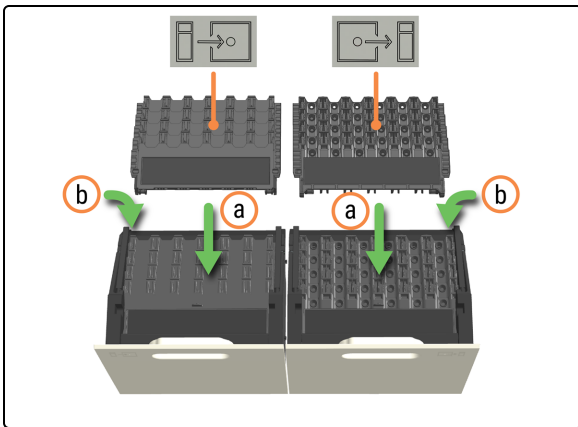

21. Refit the Slide Drawer Inserts.
- Install each Slide Drawer Insert, making sure they are fully inserted into the recess without jamming.
  - Close the locking arm after installing the inserts to auto-align the inserts and ensure good fitment.



**CAUTION:** If you are cleaning multiple inserts, ensure that the correct insert is replaced in the correct drawer and correct processing module. You cannot swap inserts between processing modules.

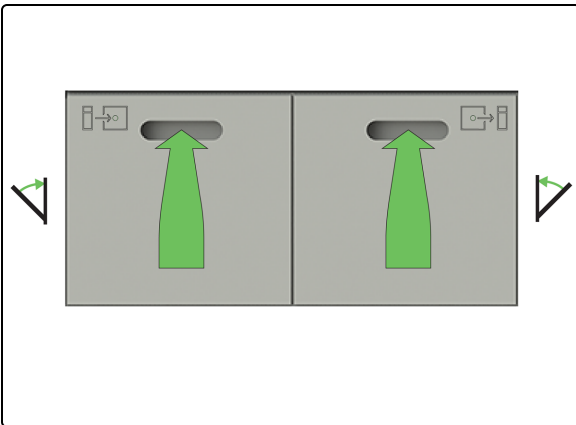

22. Close the Slide Preload and Unload Drawers.

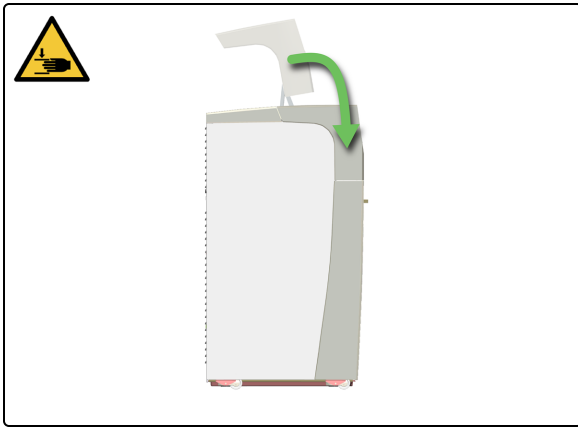

23. If you no longer require access to the Work Surface, close the Hood and then continue with this procedure.

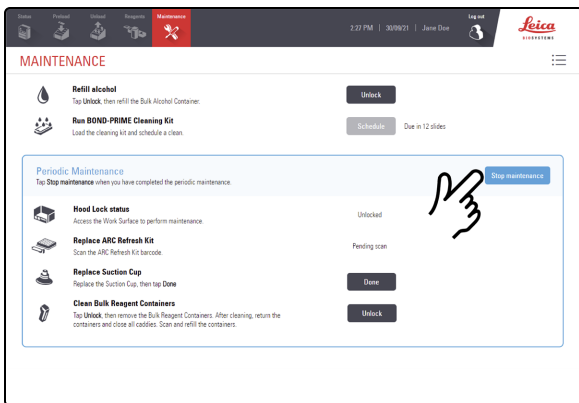

24. Tap **Stop maintenance**.

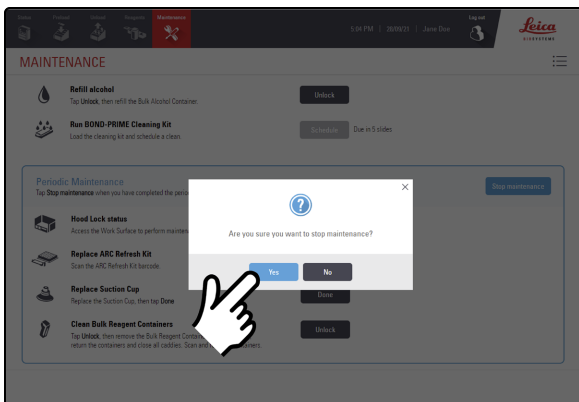

25. Tap **Yes**.

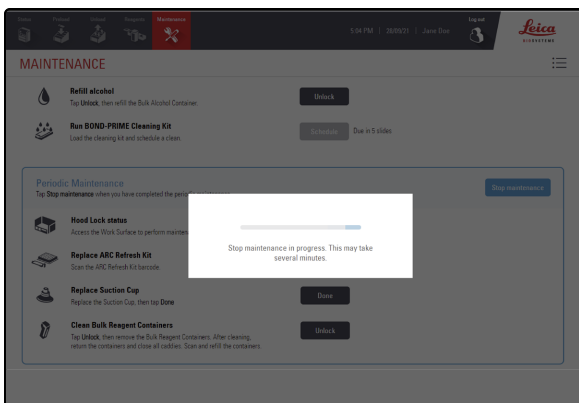

There is a wait time while the processing module is preparing to return to clinical operation.

The processing module automatically closes the ARC Modules and locks the Hood when you stop maintenance.

## 4.13 Clean the Wash/Prime Stations



**WARNING:** You must wear the minimum required PPE before you maintain the processing module. Refer to [General cautions](#).



Before you start this procedure, ensure you are logged in to the processing module. Refer to [2.1 Log in and log out](#).



1. Tap **Status**.

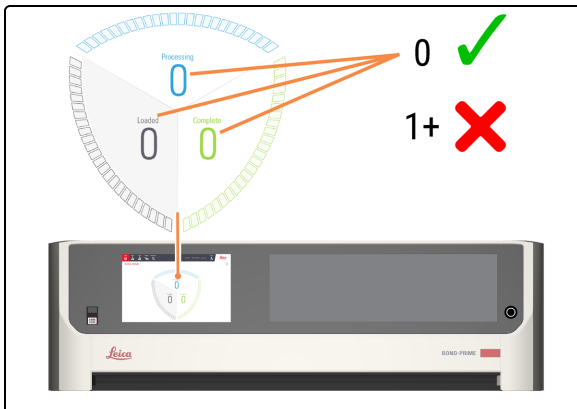

2. Check the Status screen to ensure there are:

- no slides currently being processed (Processing)
- no slides in the Preload Drawer (Loaded) and Unload Drawer (Complete).

Refer to [2.3 Status Screen](#).



3. Tap **Maintenance**.

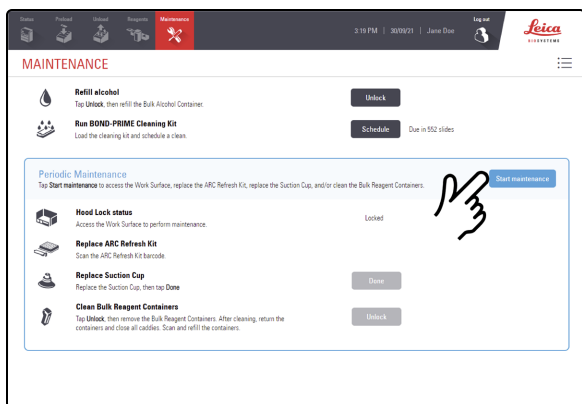

4. Tap **Start Maintenance**.

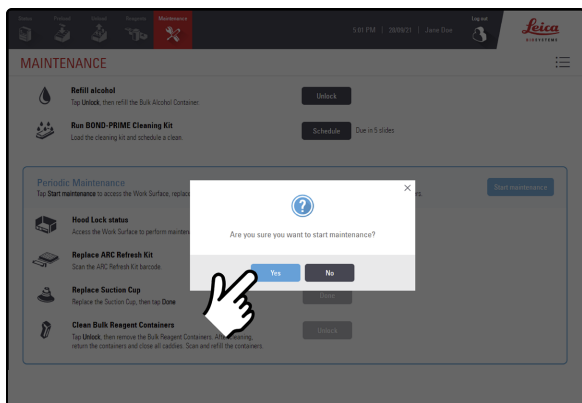

5. Tap **Yes**.

There is a wait time after tapping **Yes** while the processing module is preparing the Work Surface for maintenance and unlocking the Hood.



When maintenance is started, the processing module automatically opens all ARC Modules.



When the Hood is unlocked, the **Hood Lock Status** on the Maintenance screen changes to **Unlocked**.

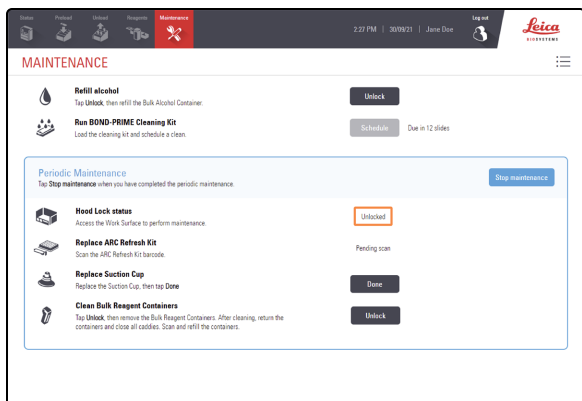

6. Locate the Wash/Prime Station locations (1, 2 & 3) on the Work Surface.



If the High-Speed Robot or Wash Robots are in the way, you can gently move them for better access to the Wash/Prime Stations.

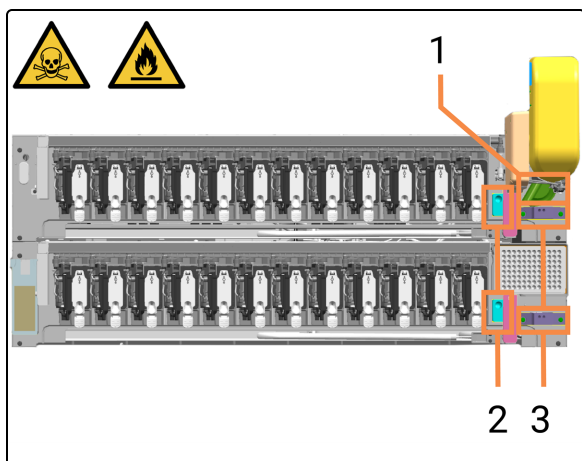

- 1 Bulk Probe Prime Station
- 2 Wash Robot Wash Stations
- 3 ARC Probe Wash Stations



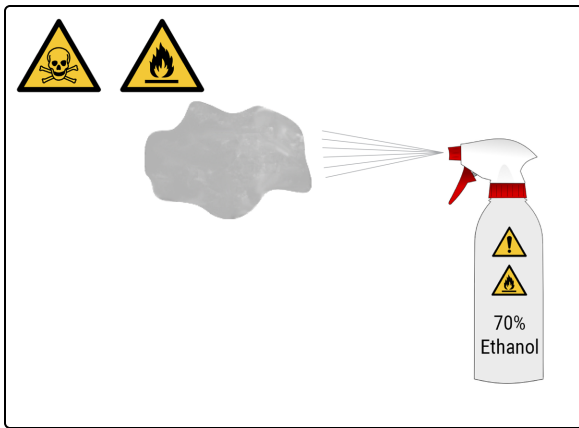

7. Moisten a clean lint-free cloth with 70% ethanol solution.

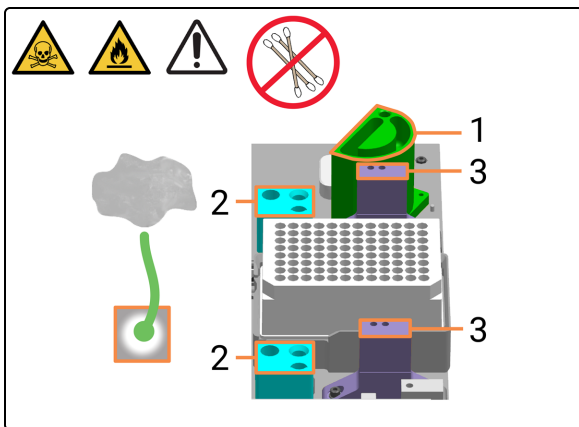

8. Clean **only** the top surfaces of Wash/Prime Stations with lint-free cloth.



**CAUTION:** Do not use cotton buds.

- 1 Bulk Probe Prime Station
- 2 Wash Robot Wash Stations
- 3 ARC Probe Wash Stations



9. If you no longer require access to the Work Surface, close the Hood and then continue with this procedure.

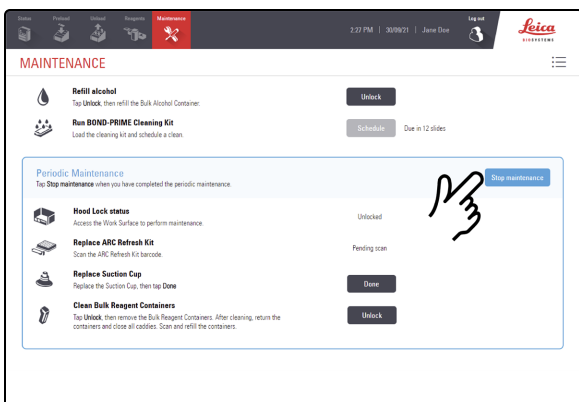

10. Tap **Stop maintenance**.

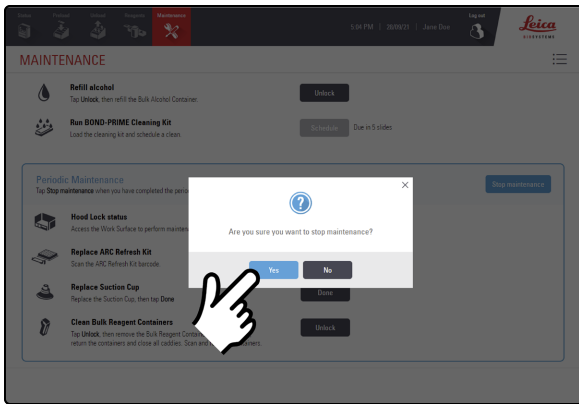
11. Tap **Yes**.

There is a wait time while the processing module is preparing to return to clinical operation.

The processing module automatically closes the ARC Modules and locks the Hood when you stop maintenance.

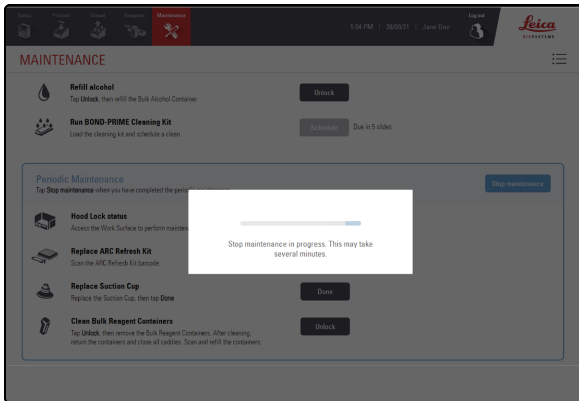

## 4.14 Use the BOND-PRIME ARC Refresh Kit

The BOND-PRIME ARC Refresh Kit contains replacement:

- Covertiles
- Mixing Well Plate.

Use the ARC Refresh Kit every 7500 slides or 8 months, whichever comes first. Each IHC single stain counts as one usage for Covertile life purposes. Each ISH hybridization counts as two usages. The maximum usage per slide is capped at two. The table below indicates the equivalent slide count per slide type.

Slide type	Equivalent slide count
IHC slide	1
ISH slide	2
Multiplex 2 to 6	2



**WARNING:** You must wear the minimum required PPE before you maintain the processing module. Refer to [General cautions](#).



Before you start this procedure, ensure you are logged in to the processing module. Refer to [2.1 Log in and log out](#).



1. Tap **Status**.

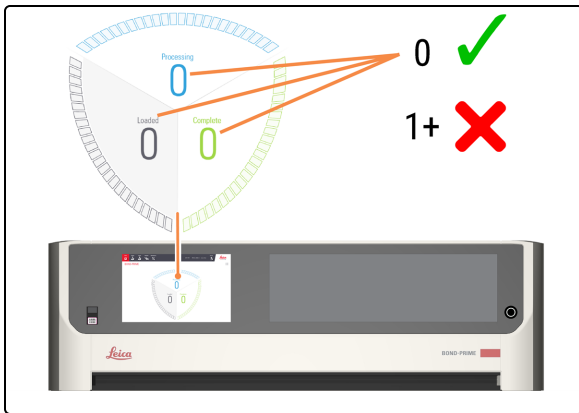

2. Check the Status screen to ensure there are:
  - no slides currently being processed (Processing)
  - no slides in the Preload Drawer (Loaded) and Unload Drawer (Complete).

Refer to [2.3 Status Screen](#).



3. Tap **Maintenance**.

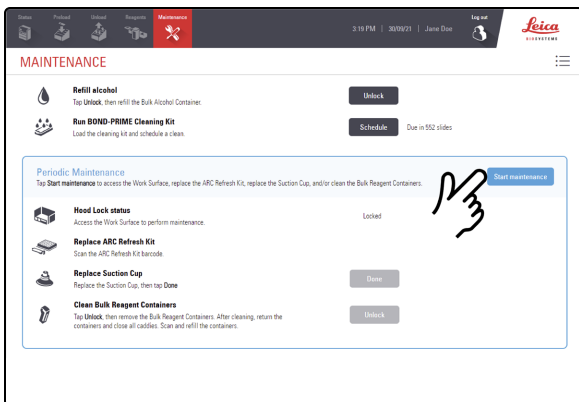

4. Tap **Start Maintenance**.

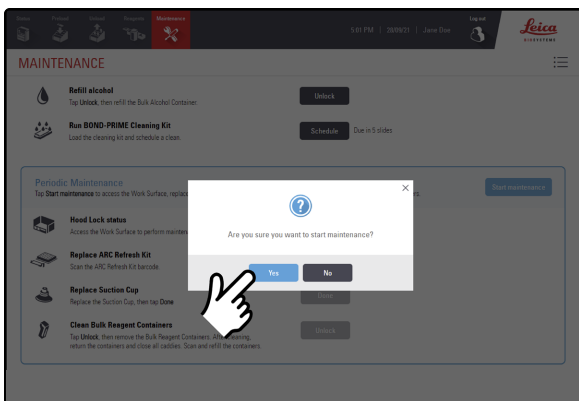

5. Tap **Yes**.

There is a wait time after tapping **Yes** while the processing module is preparing the Work Surface for maintenance and unlocking the Hood.



When maintenance is started, the processing module automatically opens all ARC Modules.

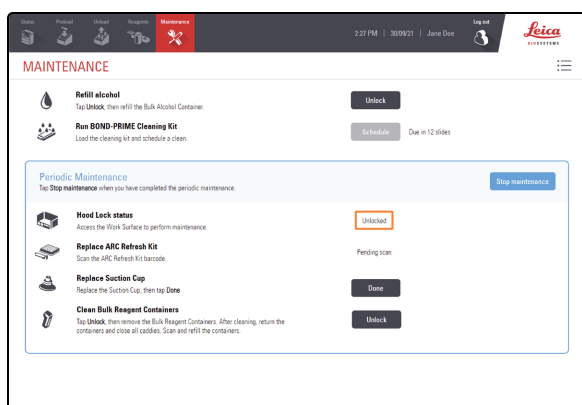

When the Hood is unlocked, the **Hood Lock Status** on the Maintenance screen changes to **Unlocked**.

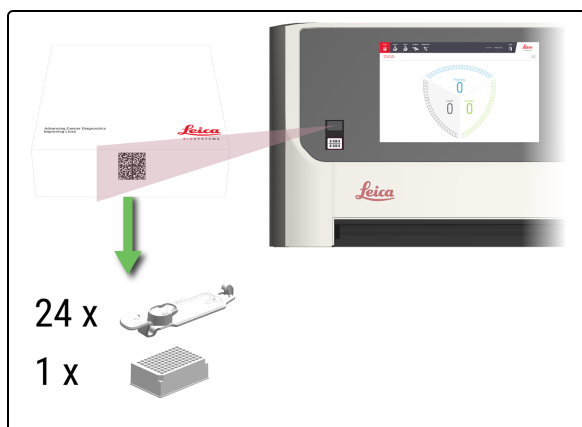

- Scan the ARC Refresh Kit barcode.



The scan is only accepted while in Maintenance Mode.



Scanning of the ARC Refresh Kit ensures that the Covertiles are cleaned with DI Water and BOND-PRIME Wash Working Solution before staining begins.

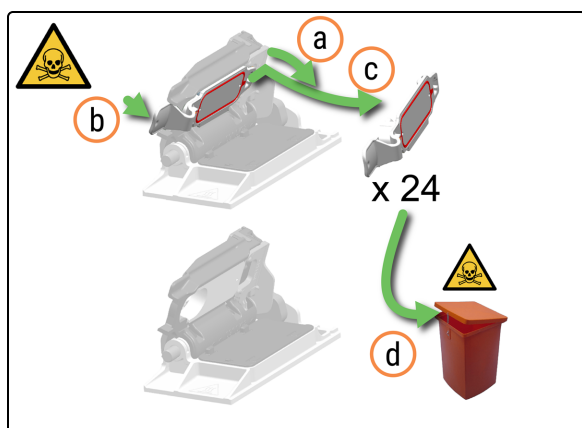

- Remove the Covertiles.
  - Push the ARC Module Latch down to make the Covertile more accessible.
  - Gently pull the Covertile Thumbhold slightly forward and towards the right of the ARC Module lid.
  - Unhook the Covertile and remove it from the ARC Module.
  - Dispose of the Covertile according to laboratory procedures.

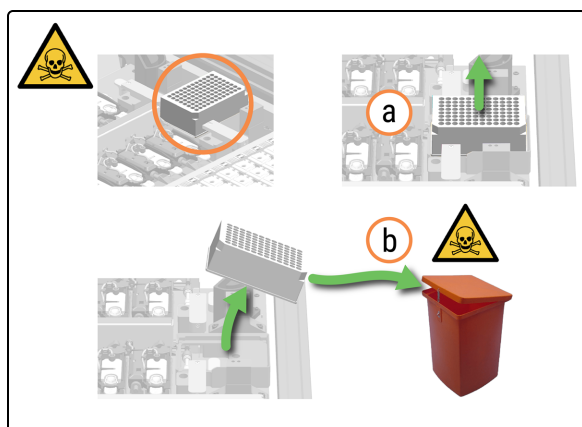

- Remove the Mixing Well Plate.
  - Lift up the Mixing Well Plate.
  - Dispose of the Mixing Well Plate according to laboratory procedures.



**WARNING:** Take care to prevent liquid spillage when removing and disposing of the Mixing Well Plate.

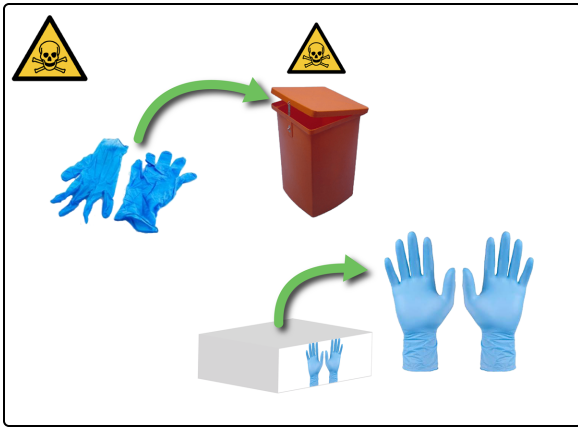

9. Remove your gloves and dispose of them according to laboratory procedures. Put on a new pair of gloves.

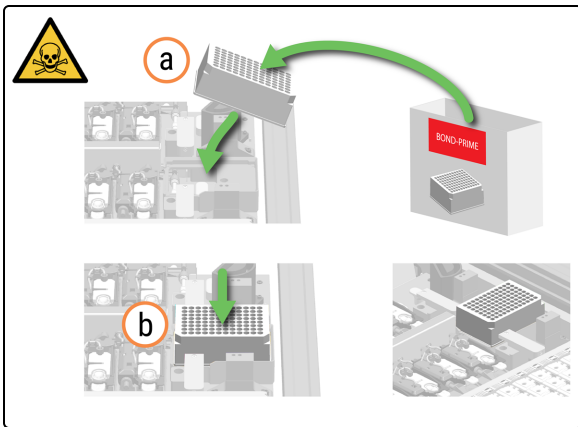

10. Install the new Mixing Well Plate.

- a. Remove the Mixing Well Plate from its packaging.
- b. Place the Mixing Well Plate on the Mixing Block.

The orientation of the Mixing Well Plate in the Mixing Block is not important as long as it is sitting evenly within the holder.

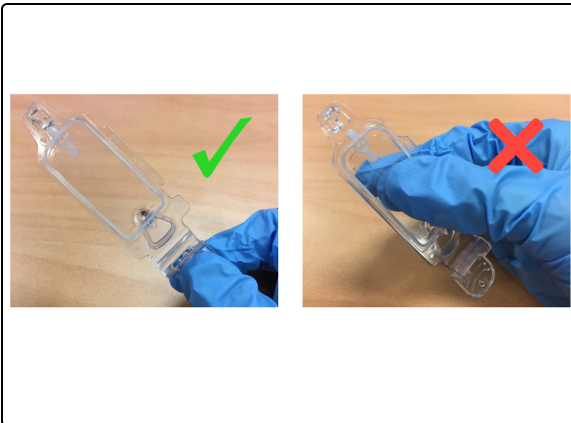

When holding the Covertile, use the thumb-hole. DO NOT put your fingers on the top plate.

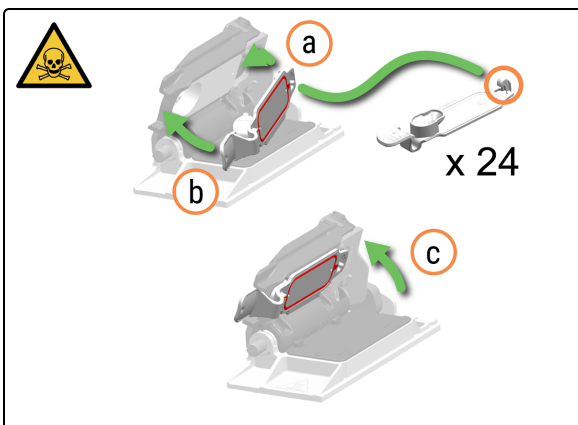

11. Insert the new Covertiles.

- a. Attach the Covertile Hook to the rear of the ARC Module.
- b. Gently push the Covertile Thumbnail until the Covertile is in place in the ARC Module.
- c. Push the ARC Module Latch up.

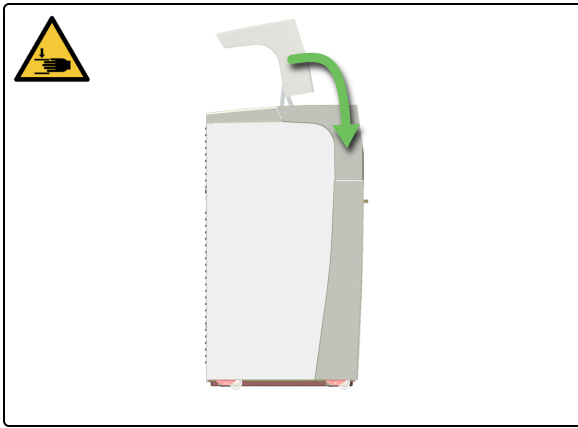

12. Close the Hood.

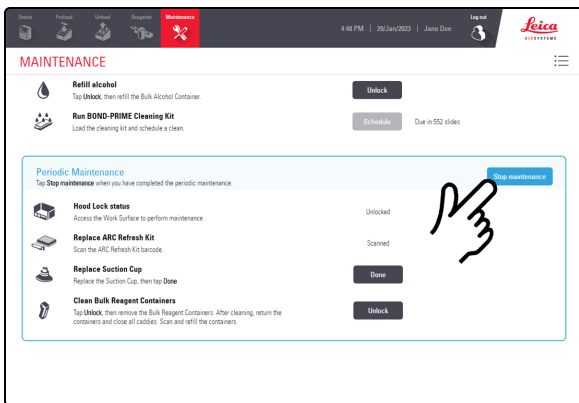

13. Tap **Stop maintenance**.

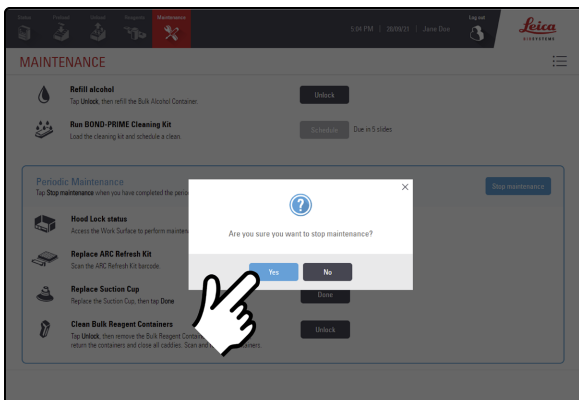

14. Tap **Yes**.

The processing module automatically closes the ARC Modules when you stop maintenance.

## 4.15 Clean the Bulk DI Water Container

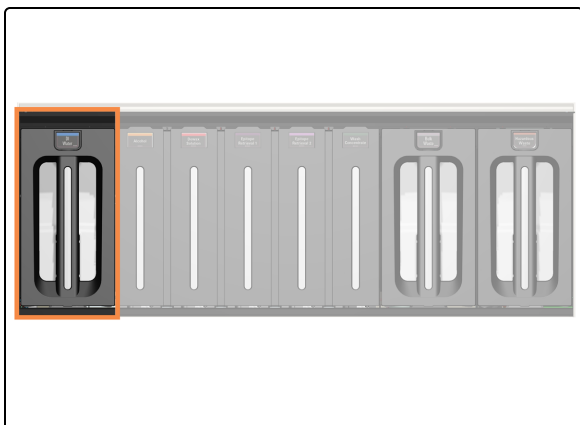

The DI Water Container is located at the left of the Bulk Containers Cabinet.

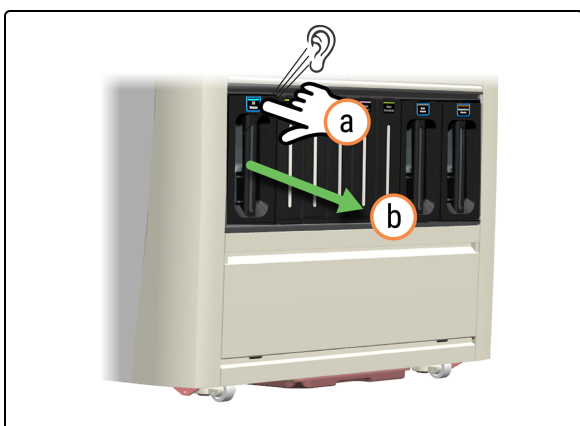

1. Remove the DI Water Container.
  - a. Press the DI Water button.
  - b. Pull the container out of the processing module.



**WARNING:** Use both hands when you lift the DI Water Container.



Return the container quickly to ensure there is DI Water available.

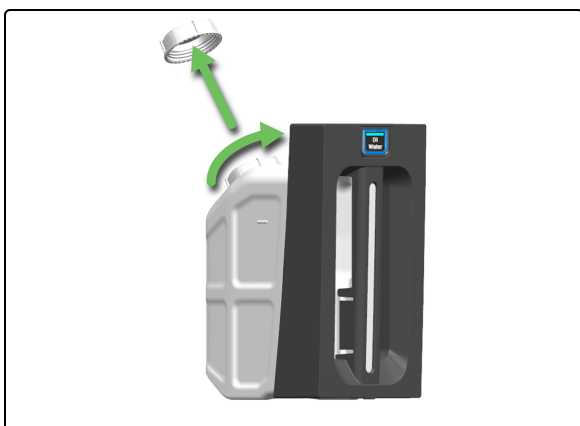

2. Remove the DI Water Container cap.



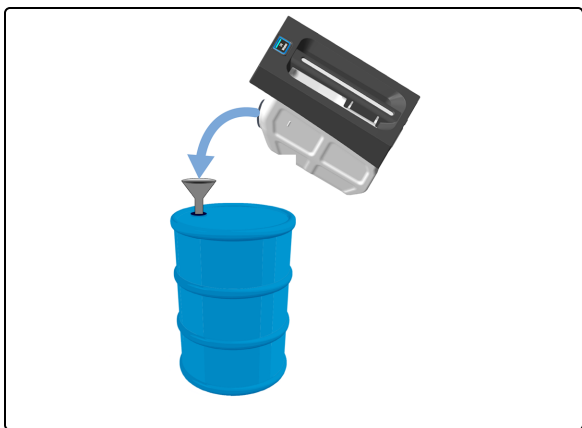

3. Dispose of the contents according to all procedures and government regulations that apply at the laboratory site.

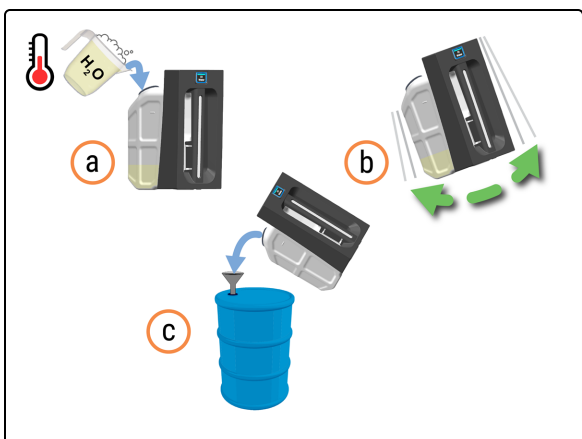

4. Clean the DI Water Container.
  - a. Quarter fill the DI Water Container with warm soapy water.
  - b. Put the lid back on the container and briskly shake the container.
  - c. Empty the contents according to your laboratory procedure.

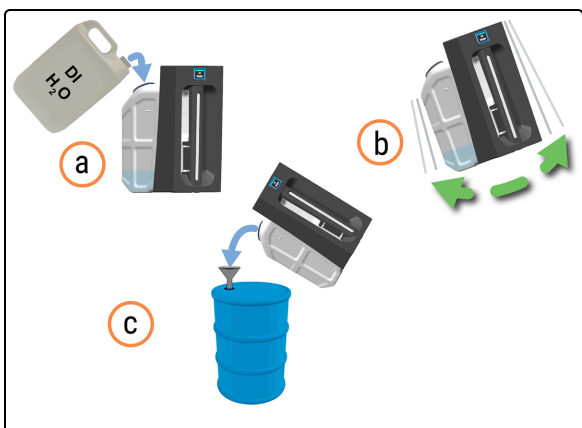

5. Rinse the DI Water Container to remove any detergent.
  - a. Quarter fill the DI Water Container with DI water.
  - b. Put the lid back on the container and briskly shake the container.
  - c. Empty the contents according to your laboratory procedure.

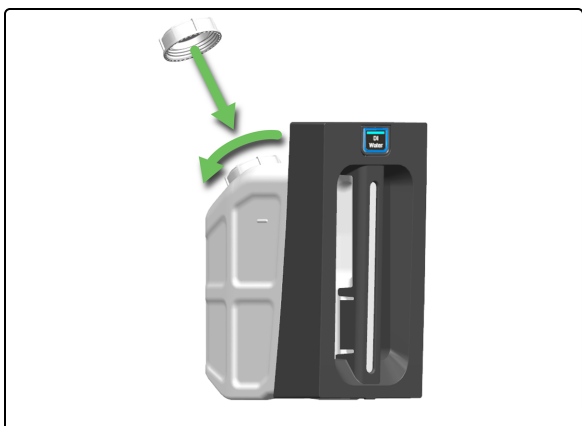

6. Refill the DI Water Container and then put the DI Water Container cap back on.

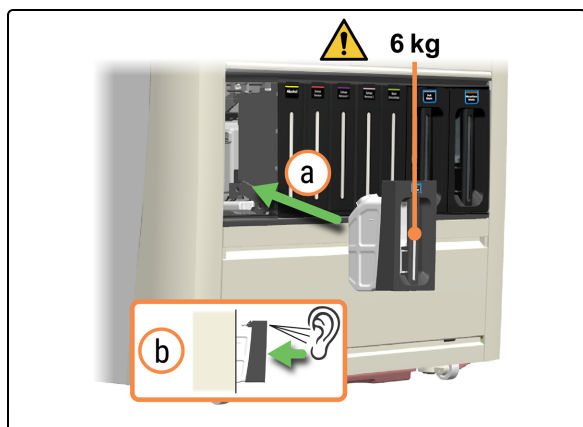

7. Reinsert the full DI Water Container.
  - a. Using two hands, reinsert the DI Water Container into the processing module.
  - b. Listen for a click sound to confirm the container is locked in place.

Make sure the container is fully inserted. Failure to do so can cause slides to be rejected in the Preload Drawer.

## 4.16 Clean the Locked Bulk Reagent Containers



**WARNING:** You must wear the minimum required PPE before you maintain the processing module. Refer to [General cautions](#).



**WARNING:** Take care not to collide with the Bulk Container Drawers while they are open.



Before you start this procedure, ensure you are logged in to the processing module. Refer to [2.1 Log in and log out](#).



1. Tap **Status**.

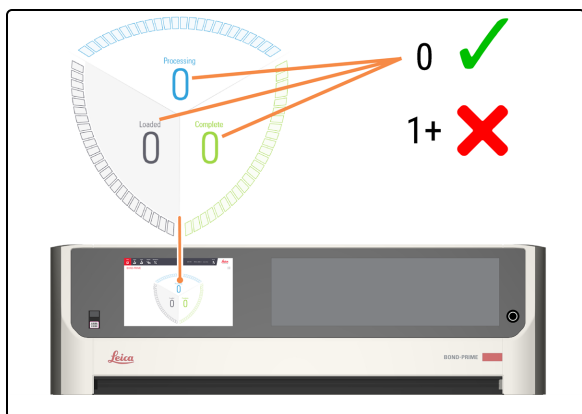

2. Check the Status screen to ensure there are:

- no slides currently being processed (Processing)
- no slides in the Preload Drawer (Loaded) and Unload Drawer (Complete).

Refer to [2.3 Status Screen](#).



3. Tap **Maintenance**.

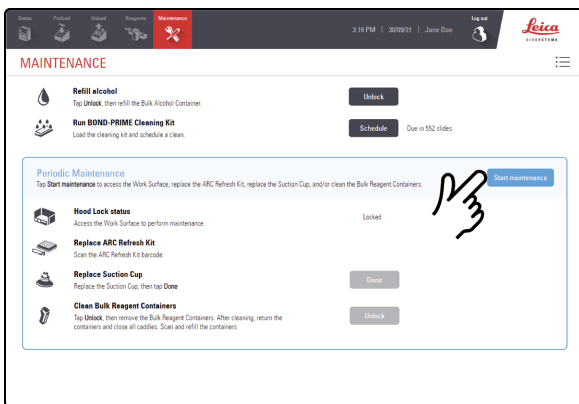

4. Tap **Start Maintenance**.

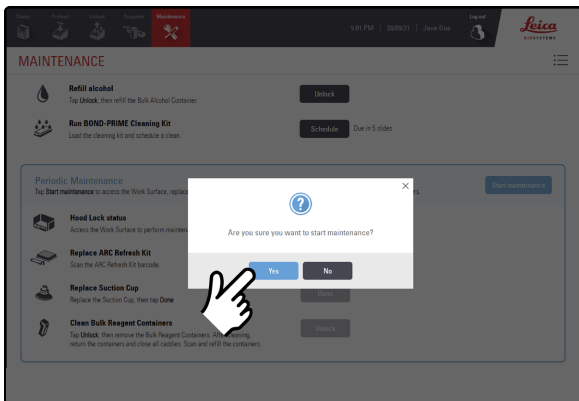

5. Tap **Yes**.

There is a wait time after tapping **Yes** while the processing module is preparing the Work Surface for maintenance and unlocking the Hood.



When maintenance is started, the processing module automatically opens all ARC Modules.



When the Hood is unlocked, the **Hood Lock Status** on the Maintenance screen changes to **Unlocked**.

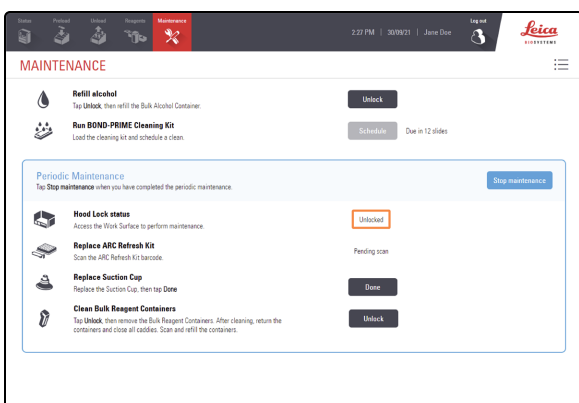

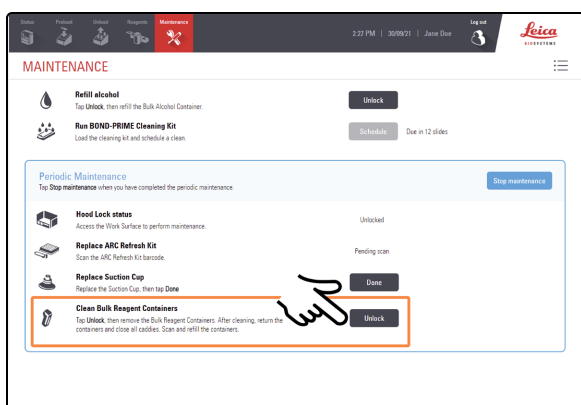

6. Tap **Unlock** next to **Clean Bulk Reagent Containers**.



The Reagent Container Caddies remain unlocked for 30 seconds, to allow time for you to open **all** drawers to the maintenance position.

If you do not have time to open them all within 30 seconds, you can tap the **Unlock** button again.



7. Pull the Locked Reagent Container Caddies forward to open them.

## For the Alcohol and Dewax Solution Containers



The two locked containers on the left are the Alcohol and Dewax Solution Containers.



Clean and then reinstall one container at a time, as the containers cannot stand upright on a flat surface.

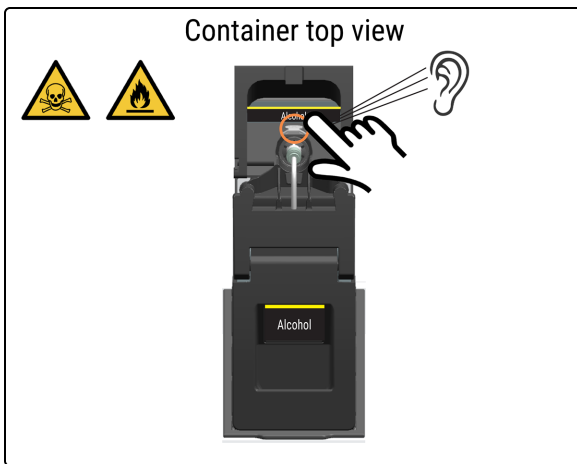

8. Press the caddy release lever at the rear of the tube connector. Listen for a click.

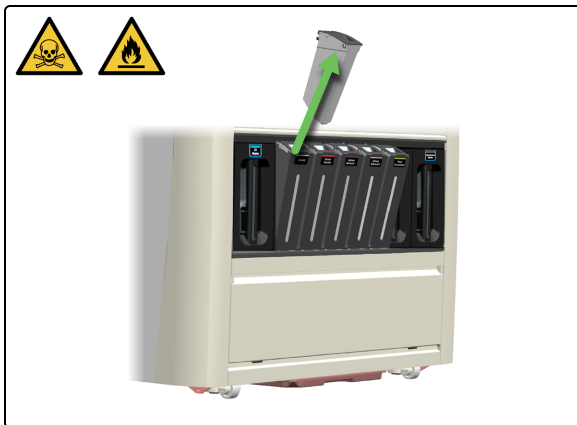

9. Slide the container up and out of the caddy.



**WARNING:** To avoid spillage, **DO NOT** refill Bulk Reagent Containers while they are away from the processing module.

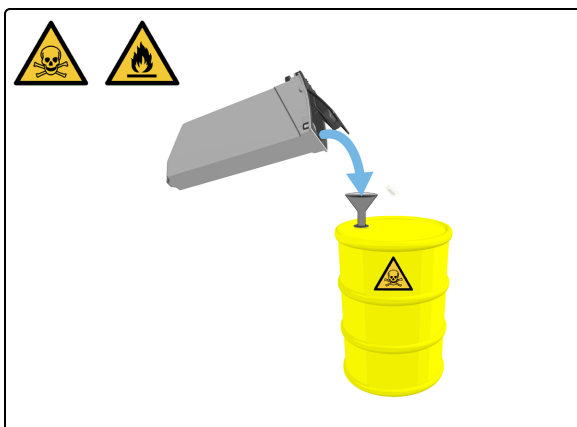

10. Empty the container into a hazardous waste drum.

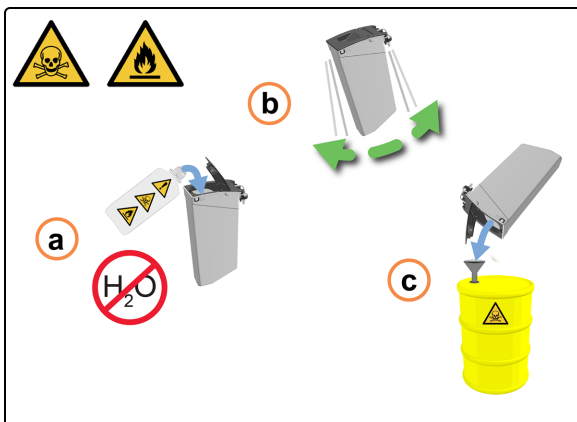

**CAUTION:** **DO NOT** use water or detergent to clean the Alcohol or Dewax Containers.

11. Decontaminate the container:
  - a. Rinse the container with a small amount of fresh Alcohol to remove any contaminants.
  - b. Gently shake the container.
  - c. Empty the container when completed.

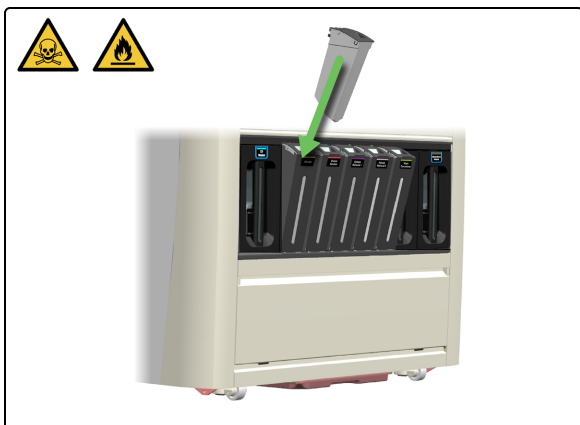

12. Close the lid and return the container to its caddy.

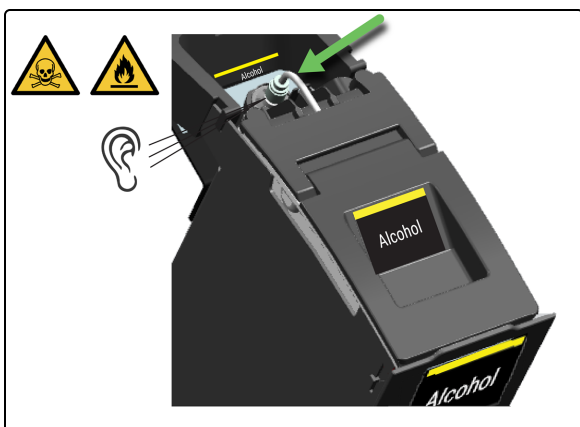

13. Push the container down until you hear a click.



14. Close the caddy.



15. Repeat [step 8](#) to [step 14](#) for the Dewax Solution Container.

If you do not need to clean any other Reagent Containers, **Stop maintenance.**

## For the ER1, ER2 and BOND-PRIME Wash Solution Concentrate Containers



The 3 containers on the right are the ER1, ER2, and BOND-PRIME Wash Solution Concentrate Containers.



Clean and then reinstall one container at a time, as the containers cannot stand upright on a flat surface.

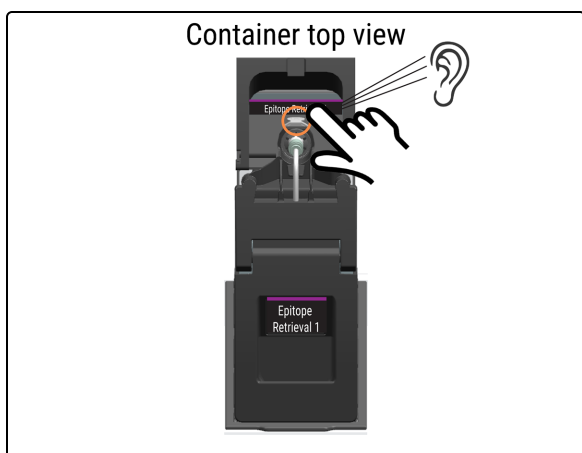

16. Press the caddy release lever at the rear of the tube connector. Listen for a click.



17. Slide the container up and out of the caddy.



**WARNING:** To avoid spillage, **DO NOT** refill Bulk Reagent Containers while they are away from the processing module.



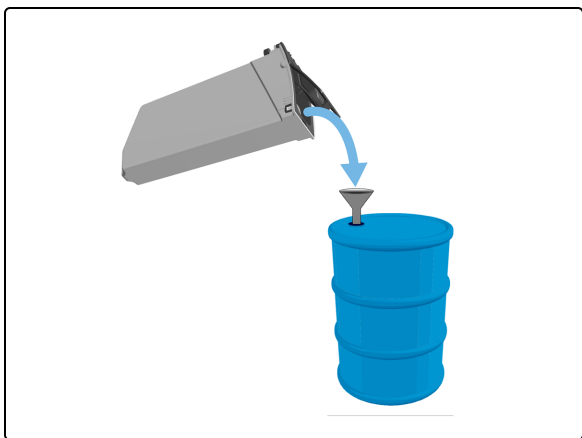

18. Empty the container according to laboratory procedures.

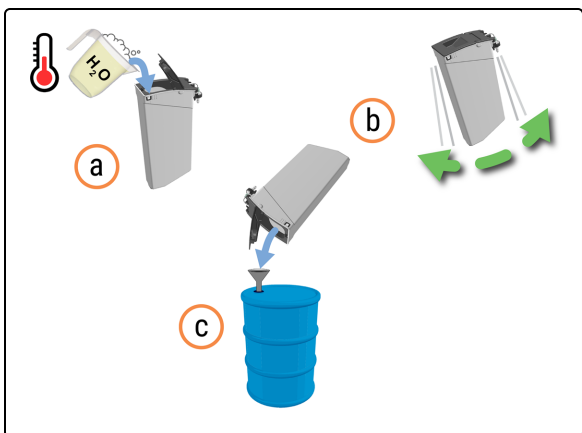

19. Clean the container:

- a. Quarter fill the container with an industrial strength detergent solution in warm tap water.
- b. Gently shake the container.
- c. Empty the container according to laboratory procedures

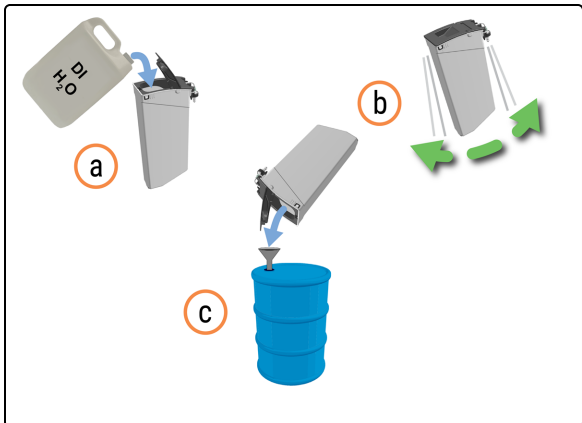

20. Rinse the container:

- a. Thoroughly rinse the container with DI Water.
- b. Gently shake the container.
- c. Empty the container according to laboratory procedures

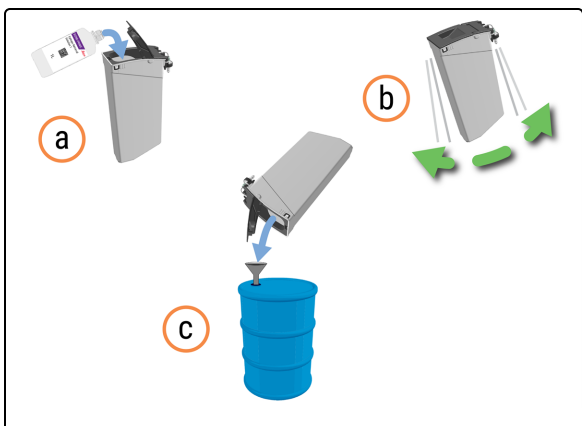

21. Decontaminate the container:

- a. Rinse the container with a small amount of fresh ER1 to remove any contaminants.
- b. Gently shake the container.
- c. Empty the container according to laboratory procedures.



22. Close the lid and return the container to its caddy.



Do not refill the container yet.

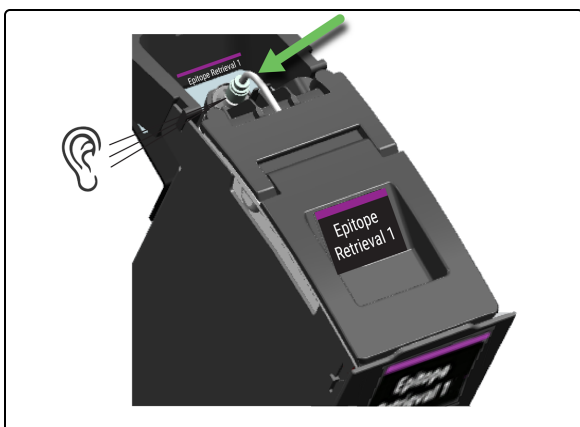

23. Push the container down until you hear a click.



24. Close the caddy.



25. Repeat [step 16](#) to [step 24](#) for the remaining Locked Reagent Containers.

## Refill the Bulk Reagent Containers

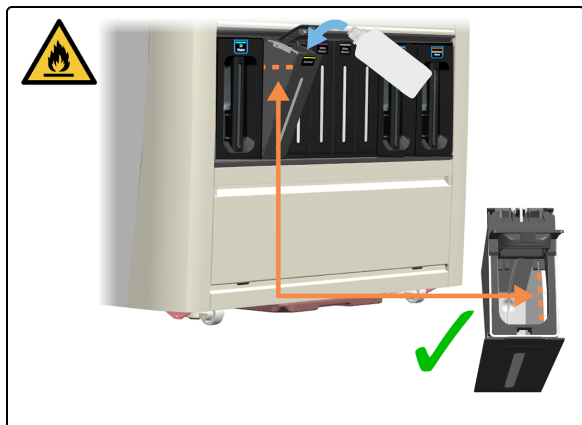

26. Refill the containers:

- 4.3 Refill the Alcohol Container
- 4.4 Refill the Lot Tracked Bulk Containers

## Stop maintenance

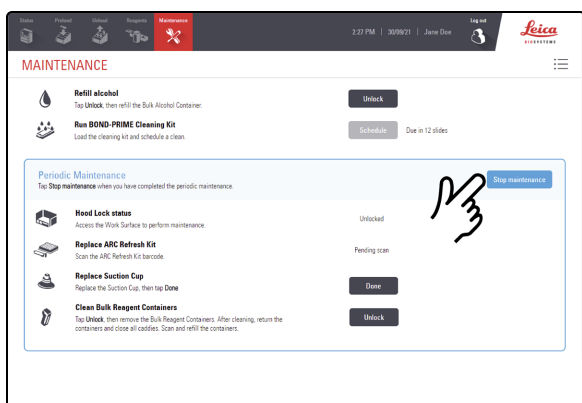

27. Tap Stop maintenance.

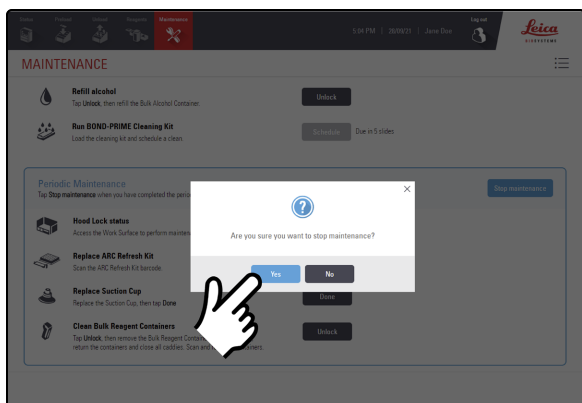

28. Tap Yes.

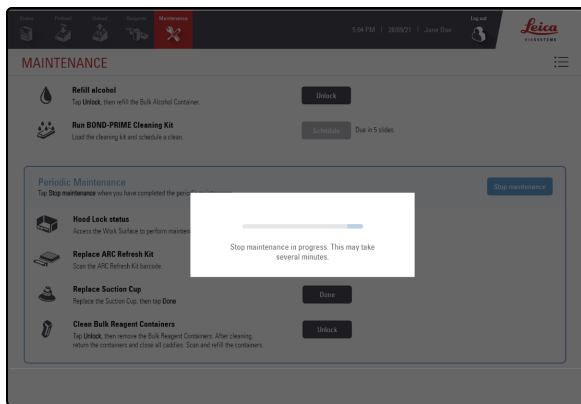

There is a wait time while the processing module is preparing to return to clinical operation.

The processing module automatically closes the ARC Modules and locks the Hood when you stop maintenance.

## 4.17 Clean the Waste Containers



**WARNING:** You must wear the minimum required PPE before you maintain the processing module. Refer to [General cautions](#).

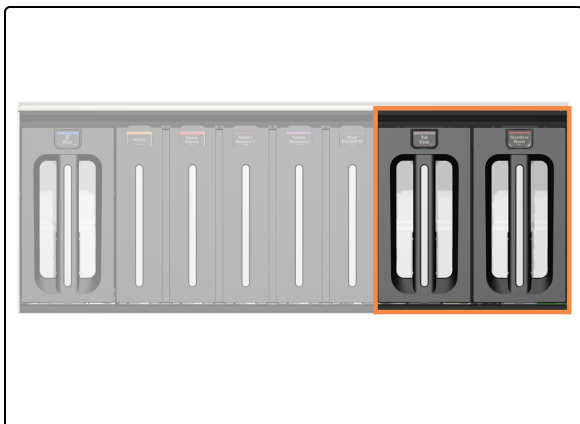

The Waste Containers are located at the right of the Bulk Container Cabinet.

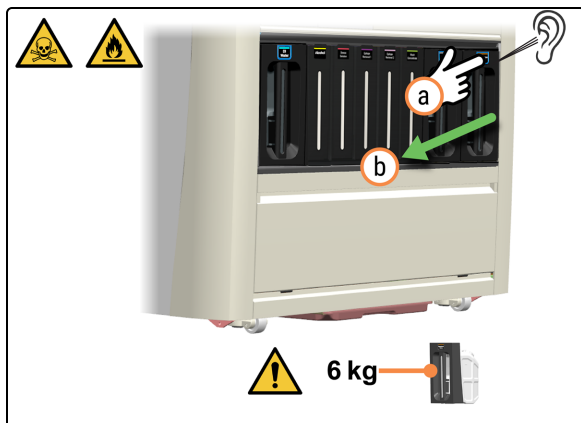

1. Remove the waste container.
  - a. Press the Waste button.
  - b. Pull the container out of the processing module.



**WARNING:** Use both hands when you lift the Bulk/Hazardous Waste containers.



2. Remove the Waste Container cap.

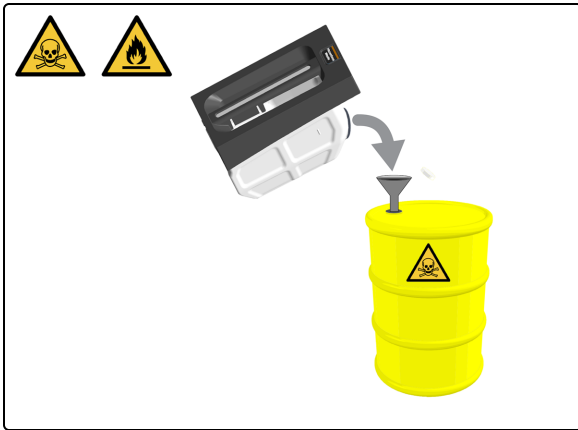

- Dispose of the contents according to all procedures and government regulations that apply at the laboratory site.



Hazardous waste example is shown.

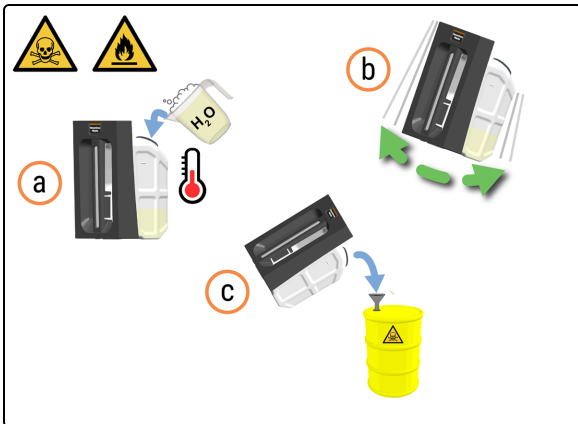

- Clean the Waste Container.
  - Quarter fill the Waste Container with an industrial strength detergent solution in warm water.
  - Put the lid back on the container and briskly shake the container.
  - Empty the contents according to your laboratory procedure.

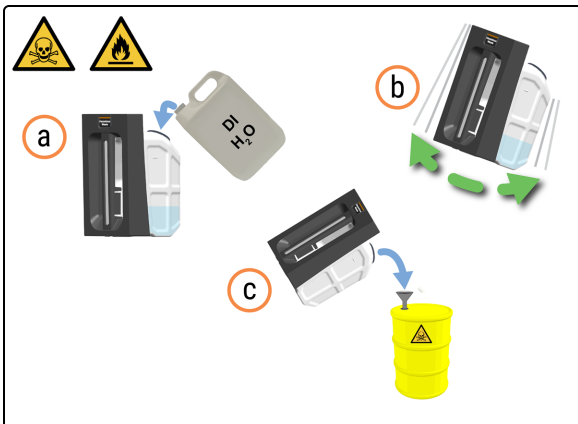

- Rinse the Waste Container.
  - Quarter fill the Waste Container with DI water.
  - Put the lid back on the container and briskly shake the container.
  - Empty the contents according to your laboratory procedure.



- Put the Waste Container cap back on.

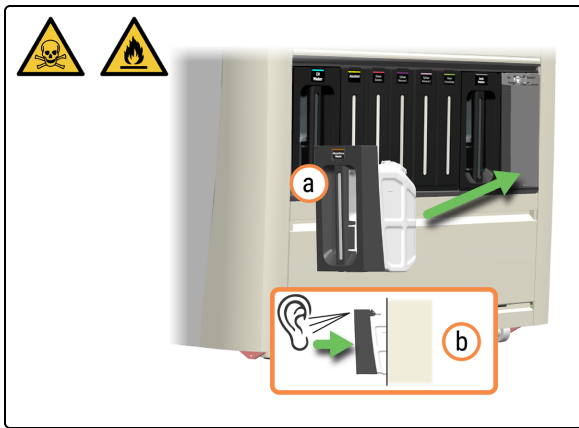

7. Reinsert the Waste Container.
  - a. Reinsert the Waste Container into the processing module.
  - b. Listen for a click sound to confirm the container is locked in place.

Make sure the container is fully inserted. Failure to do so can cause slides to be rejected in the Preload Drawer.

## 4.18 Clean the Sump Tray



**WARNING:** You must wear the minimum required PPE before you maintain the processing module. Refer to [General cautions](#).

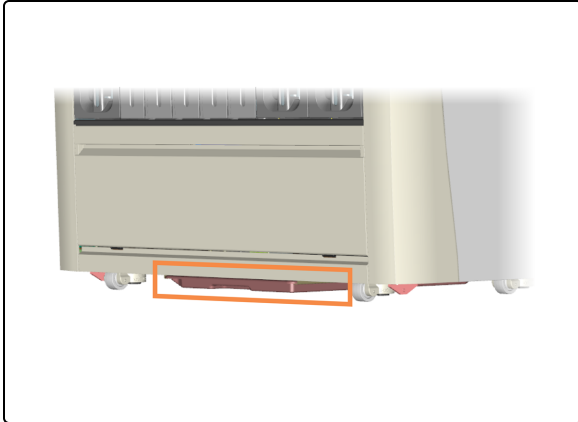

1. Locate the Sump Tray.

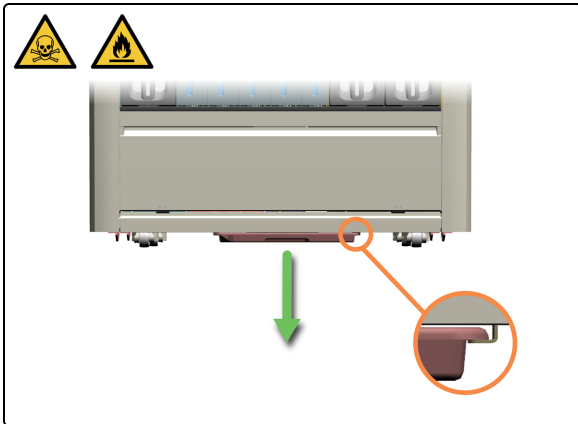

2. Stand to the side of the Sump Tray and remove it using two hands to avoid spillage. If required, follow the spill management procedures that apply at the laboratory site.

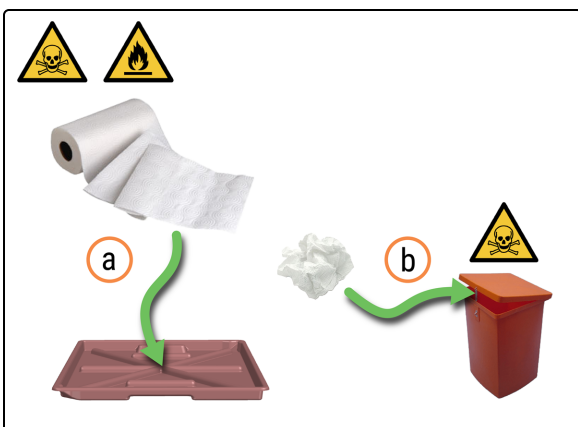

3. Soak up the excess waste reagent.

- a. Absorb the bulk of the waste reagent using paper towels.
- b. Dispose of the paper towels in accordance with laboratory procedures. Always treat the waste from the Sump Tray as hazardous.



If there is an excessive amount of waste in the Sump Tray, contact Leica Biosystems Support.



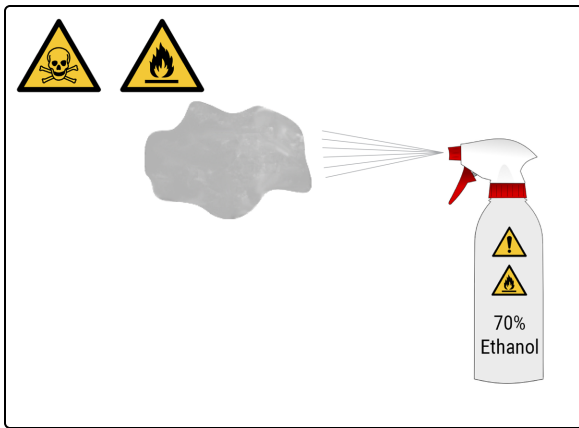

4. Moisten a clean lint-free cloth with 70% ethanol solution.

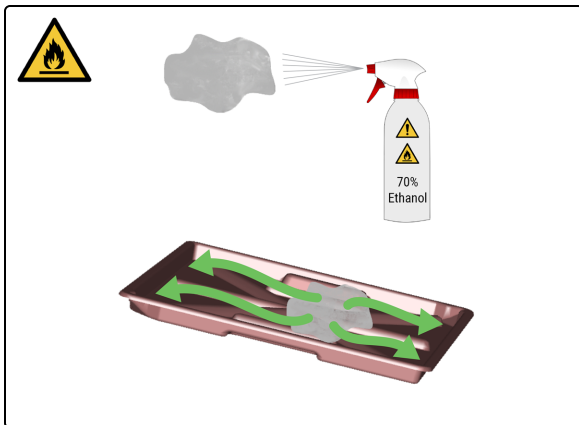

5. Wipe the Sump Tray with the lint-free cloth.

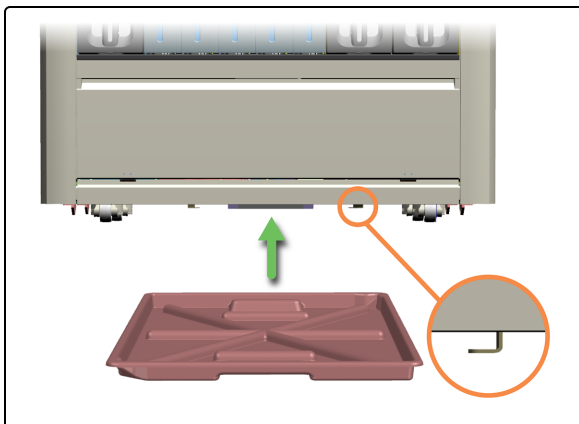

6. Refit the Sump Tray in the processing module.

## 4.19 Stop maintenance

Before you stop maintenance, make sure:

- Covertiles are present
- the Mixing Well Plate is present (see [4.14 Use the BOND-PRIME ARC Refresh Kit](#))
- Bulk Reagent Containers have sufficient volume (see [4.4 Refill the Lot Tracked Bulk Containers](#) and [4.3 Refill the Alcohol Container](#))
- no ARC Modules contain a slide (see [5.3.3 Manually retrieve slides from ARC Modules](#))
- the Hood is down



Before you start this procedure, ensure you are logged in to the processing module. Refer to [2.1 Log in and log out](#).



1. Tap **Maintenance**.

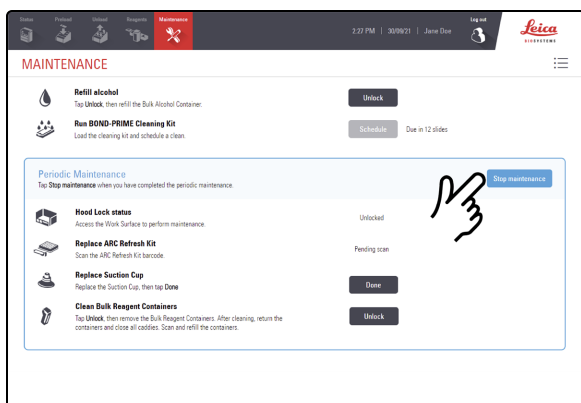

2. Tap **Stop maintenance**.

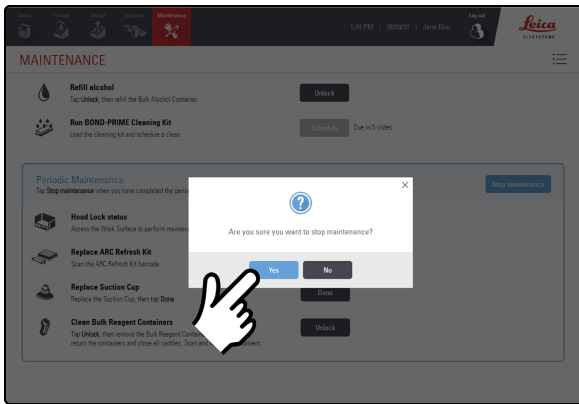
3. Tap **Yes**.

There is a wait time while the processing module is preparing to return to clinical operation.

The processing module automatically closes the ARC Modules and locks the Hood when you stop maintenance.

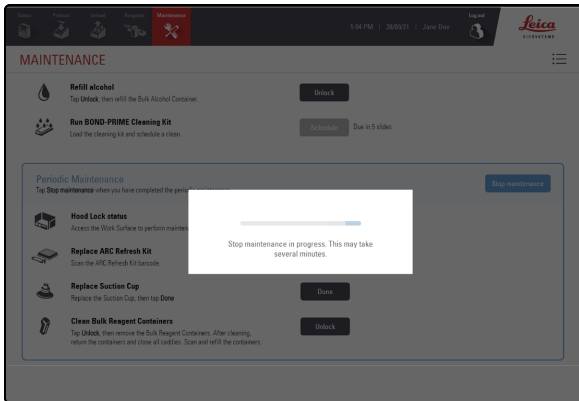

## 4.20 Shutdown the processing module



Before you start this procedure, ensure you are logged in to the processing module. Refer to [2.1 Log in and log out](#).



1. Tap **Status**.

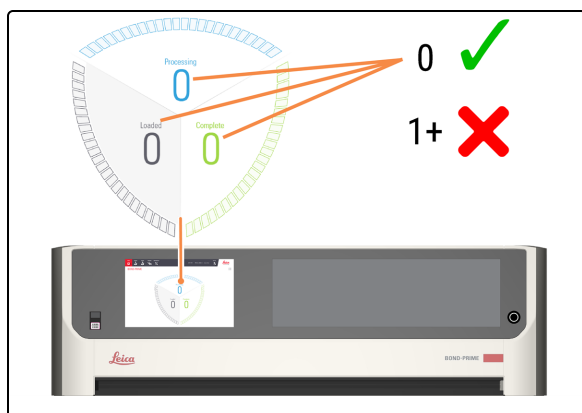

2. Check the Status screen to ensure there are:

- no slides currently being processed (Processing)
- no slides in the Preload Drawer (Loaded) and Unload Drawer (Complete).

Refer to [2.3 Status Screen](#).



3. Power down the processing module.

a. Press the standby power button.

A pop up window indicates that it is safe to shut down the processing module.

b. Tap **Close**.

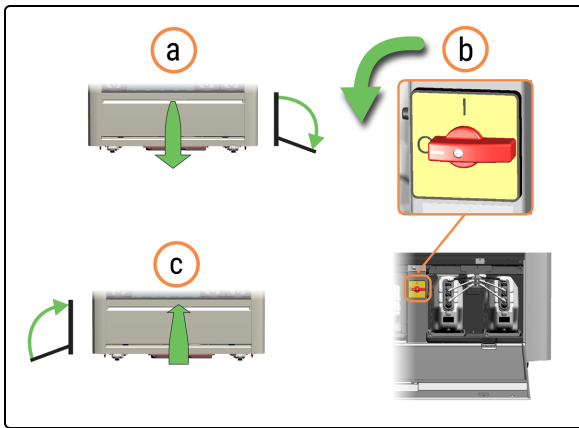

4. Power off the processing module.
  - a. Open the Reservoir Cabinet door.
  - b. Turn the AC power switch counterclockwise.
  - c. Close the Reservoir Cabinet door.



**WARNING:** Take care not to trip over the Reservoir Cabinet door when it is in the open position.

## 4.21 Replace power supply fuses

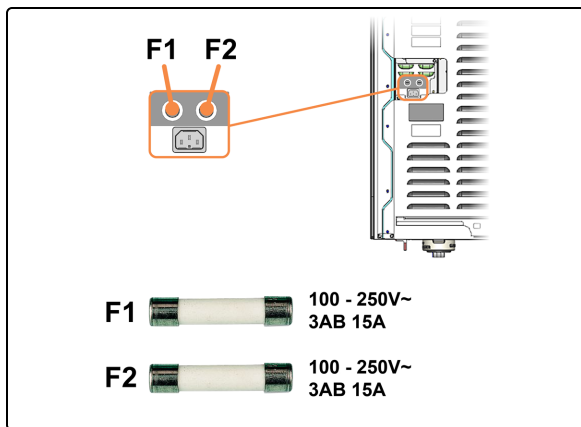

1. Ensure you have the correct fuses (F1, F2).  
The fuses are located at the rear of the processing module.



You may need to move the processing module for better access to the fuses and mains-power connector on the rear-panel.

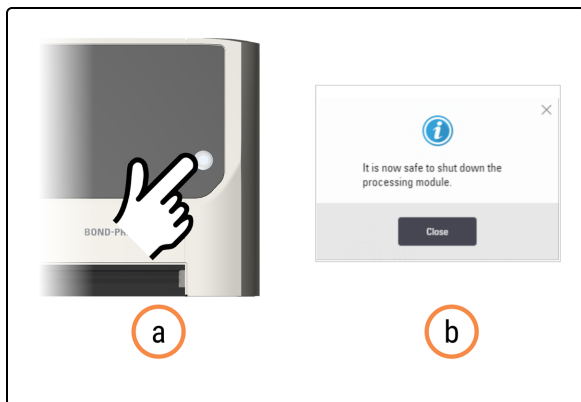

2. Power down the processing module.
  - a. Press the standby power button.  
A pop up window indicates that it is safe to shut down the processing module.
  - b. Tap **Close**.

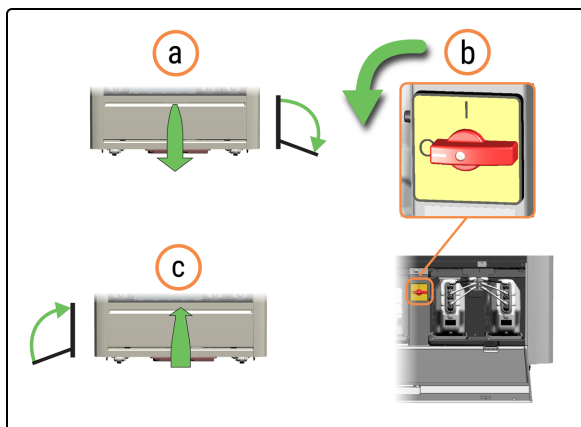

3. Power off the processing module.
  - a. Open the Reservoir Cabinet door.
  - b. Turn the AC power switch counterclockwise.
  - c. Close the Reservoir Cabinet door.



**WARNING:** Take care not to trip over the Reservoir Cabinet door when it is in the open position.

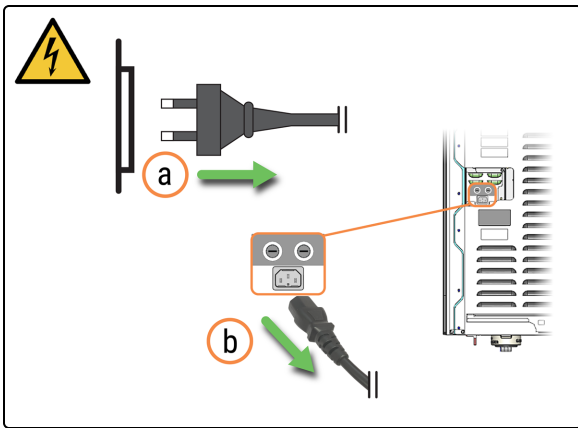

4. Unplug the mains power cable.
  - a. Unplug the mains power cable from the wall socket.
  - b. Unplug the mains power cable from the rear of the processing module.



You may need to move the processing module for better access to the rear-panel connectors.

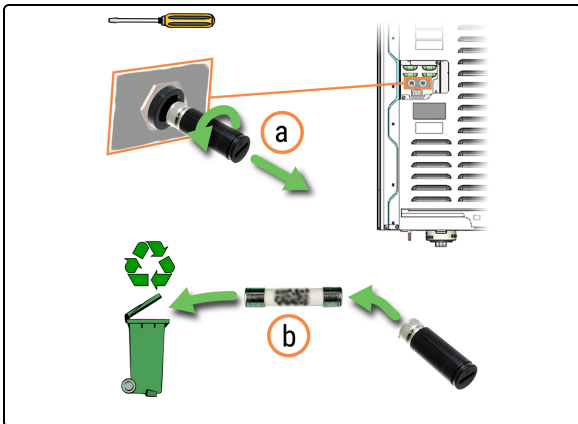

5. Dispose of the fuse.
  - a. Using a flat-bladed screwdriver, turn the fuse holder counter-clockwise and remove it from the processing module.
  - b. Dispose of the fuse in the recycling bin.

Do not dispose of old fuses in the general trash. Recycle if possible.

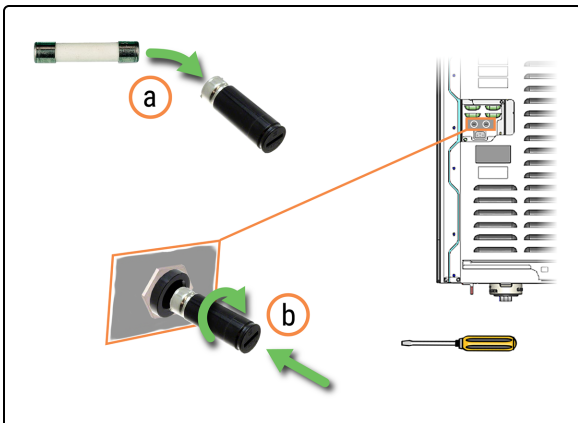

6. Install the new fuse.
  - a. Remove the new fuse from its packaging.
  - b. Insert the fuse holder into the processing module then use a flat-bladed screwdriver to turn the fuse holder clockwise until tight.

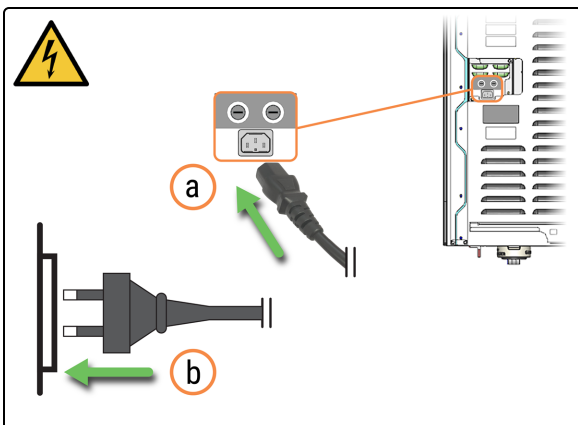

7. Plug in the mains power cable.
  - a. Plug the mains power cable into the rear of the processing module.
  - b. Plug the mains power cable into the wall socket.



You may need to move the processing module for better access to the rear-panel connectors.

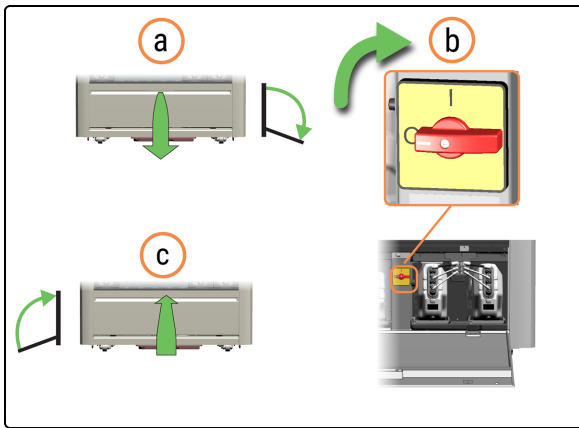

8. Power on the processing module.
  - a. Open the Reservoir Cabinet door.
  - b. Turn the AC power switch clockwise.
  - c. Close the Reservoir Cabinet door.



9. When the processing module is turned on, it initializes before displaying the Log In Screen. This process takes from 8 to 15 minutes. If the processing module fails to initialize, refer to [5.1 Failure to initialize](#).

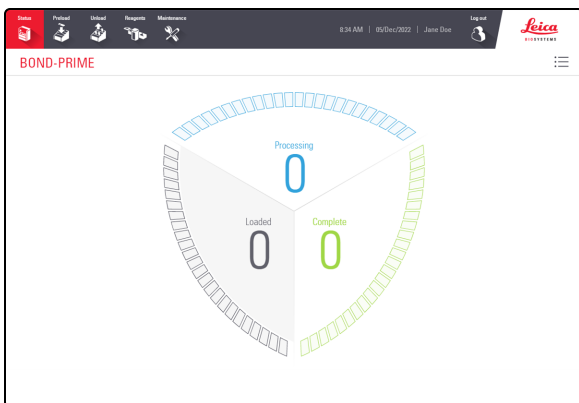

The Status screen is displayed.



# 5 Troubleshooting

In this section:

5.1 Failure to initialize .....	186
5.2 Network connectivity error .....	186
5.3 Manually retrieve slides from the processing module .....	186
5.4 Remove a slide fragment from an ARC Module .....	194

## 5.1 Failure to initialize

There are a number of reasons why the processing module may fail to initialize. These include:

- A Covertile has not been installed correctly in an ARC Module—refer to [4.14 Use the BOND-PRIME ARC Refresh Kit](#)
- Robots are obstructed or prevented from moving freely—refer to [4.20 Shutdown the processing module](#)
- There are slides left behind on the Work Surface—refer to [5.3.2 Manually retrieve slides from the Work Surface](#)
- Mixing Well Plate is not present—refer to [4.14 Use the BOND-PRIME ARC Refresh Kit](#)
- One or more Bulk Reagent Containers is empty or not inserted properly back into the processing module—refer to [4.4 Refill the Lot Tracked Bulk Containers](#)
- Network connectivity issues—refer to [5.2 Network connectivity error](#).

If the problem persists, contact customer support.

## 5.2 Network connectivity error

- 1 Check that the processing module is connected to the BOND Controller and all network cables are plugged in.



The BOND Controller must be up and running before connecting the processing modules.

- 2 Restart the processing module.

## 5.3 Manually retrieve slides from the processing module

The processing module might occasionally indicate that slide processing cannot continue and you need to manually retrieve slides. You can retrieve slides from the following locations:

- Preload Drawer—refer to [5.3.1 Manually retrieve slides from Preload and Unload Drawers](#)
- Unload Drawer—refer to [5.3.1 Manually retrieve slides from Preload and Unload Drawers](#)
- Work Surface—refer to [5.3.2 Manually retrieve slides from the Work Surface](#)
- ARC Modules—refer to [5.3.3 Manually retrieve slides from ARC Modules](#)

There are a number of reasons why slides might be dropped. These include:

- the Suction Cup on the High-Speed Robot needs cleaning or replacement. Refer to [4.10 Clean the Suction Cup](#) or [4.11 Replace the Suction Cup](#)
- the label has been incorrectly placed on the slide, or there are more than two labels on the slide. Refer to [Slide label specifications](#)

- there is tissue, residue, or liquid on the slide label area.
- there is an issue with the Vacuum System
- the Preload Drawer or Unload Drawer has been replaced and is out of alignment.

The Action Queue will display a message indicating the cause of the issue and the action required to rectify it.

If slide transfer continuously fails, contact customer support.

## 5.3.1 Manually retrieve slides from Preload and Unload Drawers



**WARNING:** You must wear the minimum required PPE before you maintain the processing module. Refer to [General cautions](#).

If prompted by a message in the Action Queue to remove slides from the Preload or Unload Drawer, follow this procedure.

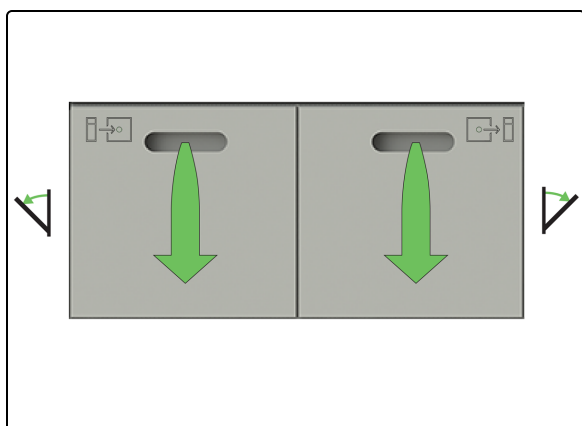

1. Open the Preload and Unload Drawers and remove the slides.

Check the drawers for debris. If there is debris, clean the drawers. Refer to [4.12 Clean the Slide Drawer Inserts, Waste Drains and Sumps, and Pickup Filter](#).

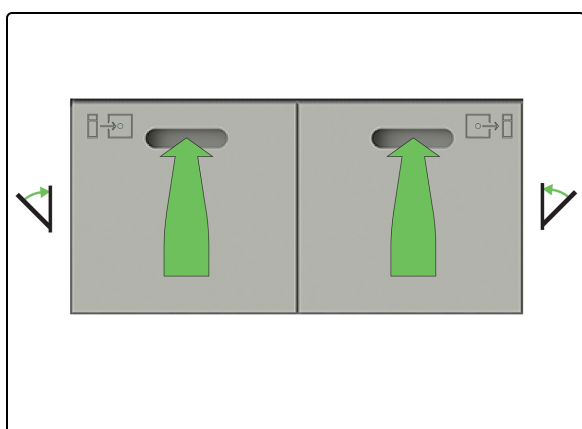

2. Close the Slide Preload and Unload Drawers.

## 5.3.2 Manually retrieve slides from the Work Surface



**WARNING:** You must wear the minimum required PPE before you maintain the processing module. Refer to [General cautions](#).



Before you start this procedure, ensure you are logged in to the processing module. Refer to [2.1 Log in and log out](#).

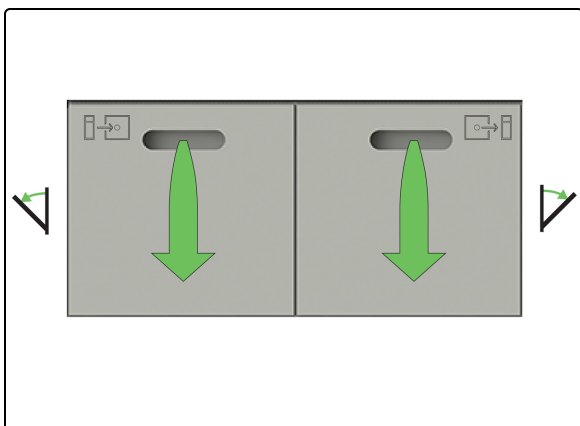

1. Open the Preload and Unload Drawers and retrieve the slides.

Check the drawers for debris. If there is debris, clean the drawers. Refer to [4.12 Clean the Slide Drawer Inserts, Waste Drains and Sumps, and Pickup Filter](#).

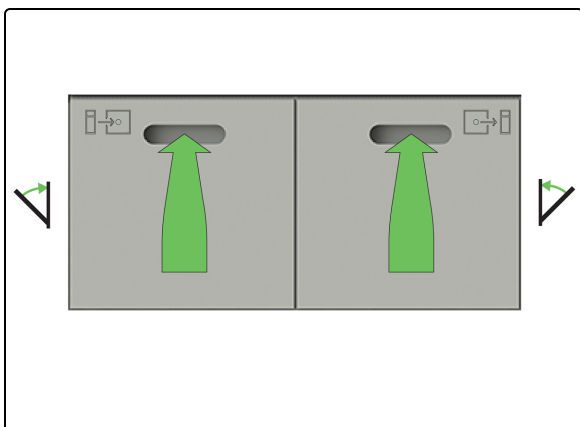

2. Close the Slide Preload and Unload Drawers.



3. Press the standby power button.

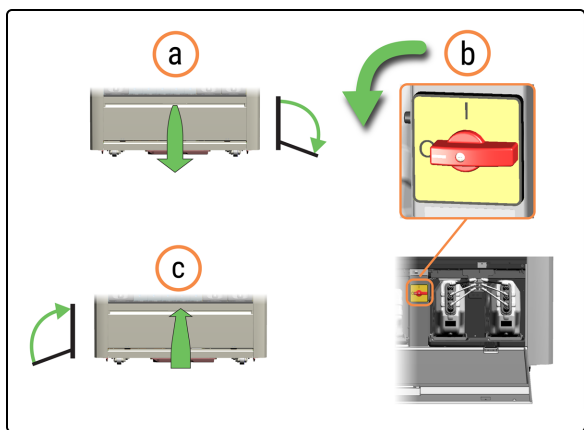

4. Power off the processing module.
  - a. Open the Reservoir Cabinet door.
  - b. Turn the AC power switch counterclockwise.
  - c. Close the Reservoir Cabinet door.



**WARNING:** Take care not to trip over the Reservoir Cabinet door when it is in the open position.

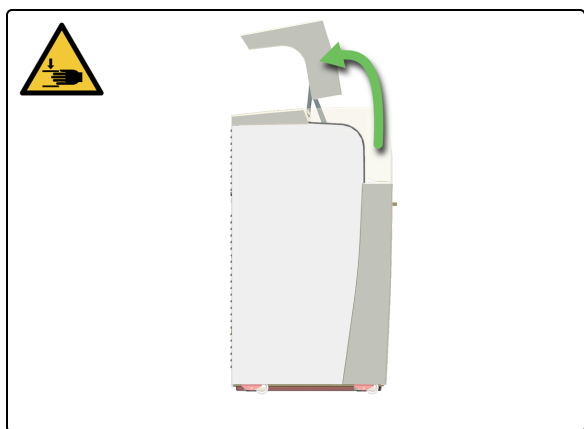

5. Open the Hood and retrieve the slides.

Check the Work Surface for debris. If there is debris, clean the Work Surface. Refer to [4.9 Wipe down Reagent Platform and ARC Bank Surfaces](#).

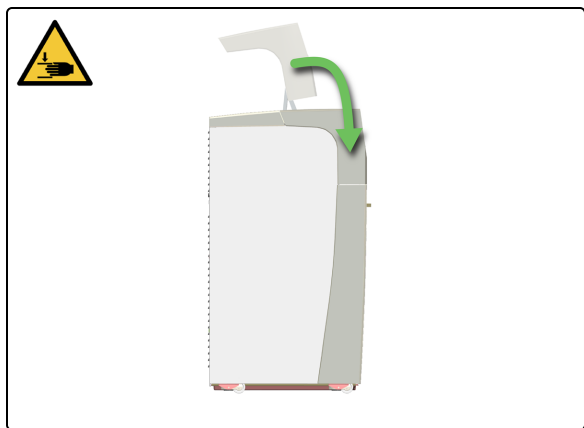

6. If you no longer require access to the Work Surface, close the Hood and then continue with this procedure.



7. Restart the processing module. Refer to [3.2 Start the processing module](#).

## 5.3.3 Manually retrieve slides from ARC Modules



**WARNING:** You must wear the minimum required PPE before you maintain the processing module. Refer to [General cautions](#).



Before you start this procedure, ensure you are logged in to the processing module. Refer to [2.1 Log in and log out](#).

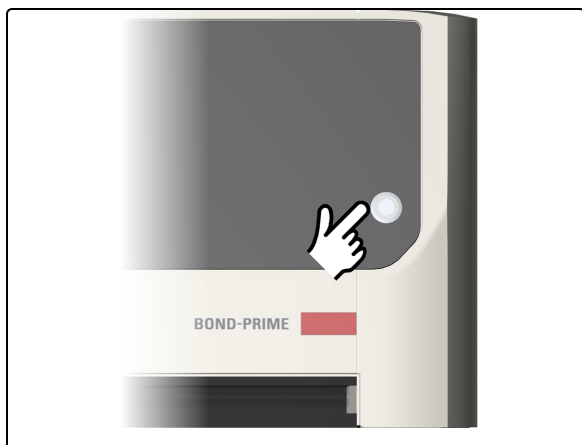

1. Press the standby power button.

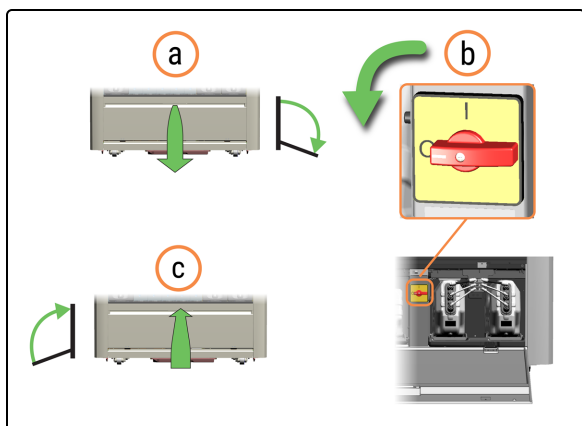

2. Power off the processing module.
  - a. Open the Reservoir Cabinet door.
  - b. Turn the AC power switch counterclockwise.



**WARNING:** Take care not to trip over the Reservoir Cabinet door when it is in the open position.

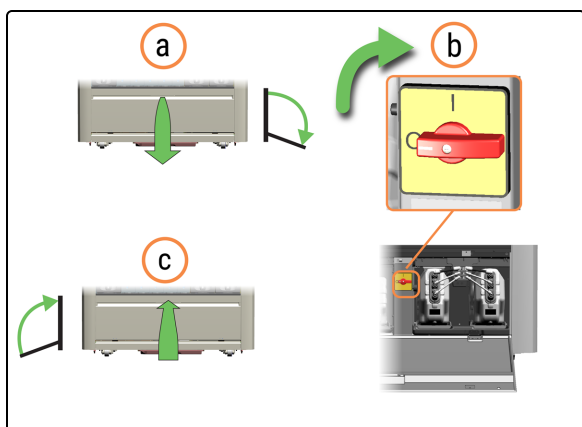

3. Power on the processing module.
  - a. Turn the AC power switch clockwise.



Initialization will fail, but the ARC Modules with slides detected are automatically opened.

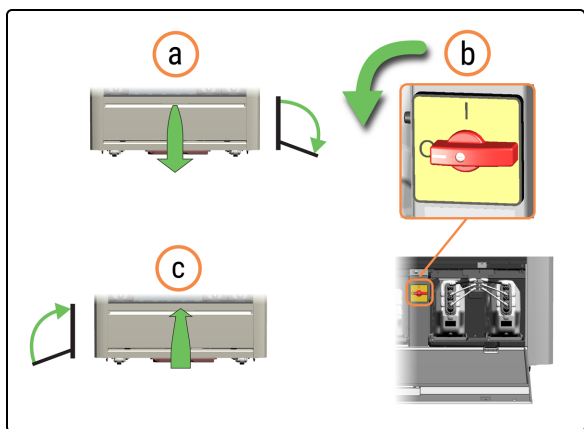

4. Power off the processing module again.
  - a. Turn the AC power switch counterclockwise.
  - b. Close the Reservoir Cabinet door.

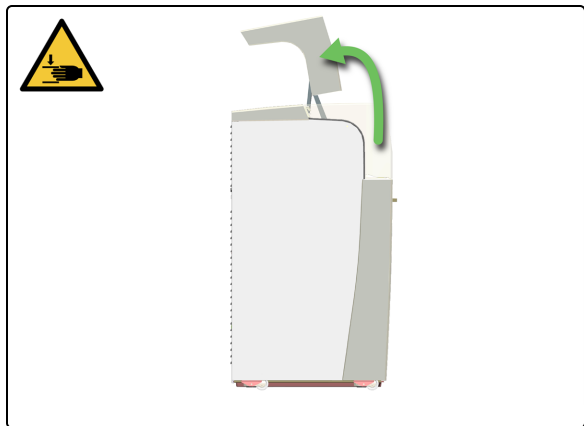

5. Open the Hood.

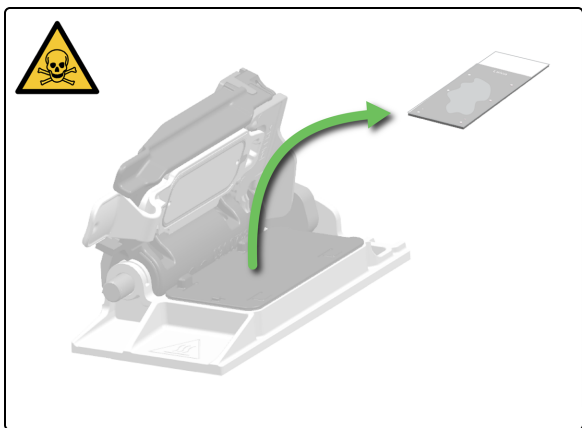

- Remove the slide from the ARC Module and leave it fully opened. The ARC Modules are automatically closed when you restart the processing module.



You can manually move the Wash Robots to gain better access to the ARC Modules.



**CAUTION:** Be careful not to drop slides when manually handling them over the Work Surface.



**CAUTION:** Do not close the ARC Modules manually. This is done automatically when you start the processing module.

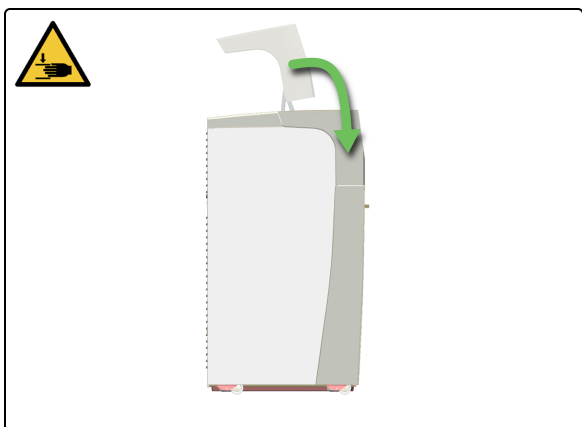

- If you no longer require access to the Work Surface, close the Hood and then continue with this procedure.



- Restart the processing module. Refer to [3.2 Start the processing module](#).



In the event of a power failure, refer to [5.3.4 Manually retrieve slides from ARC Modules during a power failure](#).



## 5.3.4 Manually retrieve slides from ARC Modules during a power failure

In the event of a power failure, you can follow these steps to manually remove slides.



**WARNING:** You must wear the minimum required PPE before you maintain the processing module. Refer to [General cautions](#).

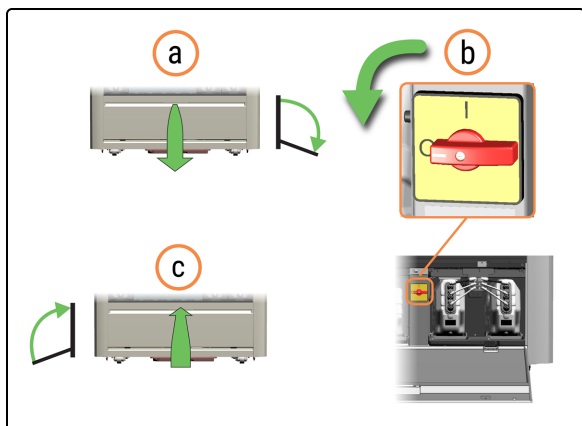

1. Power off the processing module.
  - a. Open the Reservoir Cabinet door.
  - b. Turn the AC power switch counterclockwise.
  - c. Close the Reservoir Cabinet door.



**WARNING:** Take care not to trip over the Reservoir Cabinet door when it is in the open position.

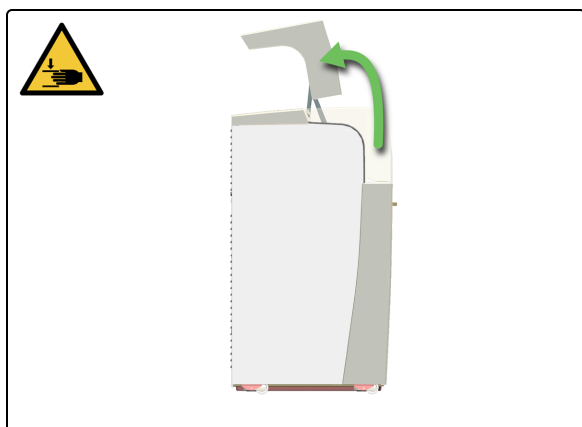

2. Open the Hood.

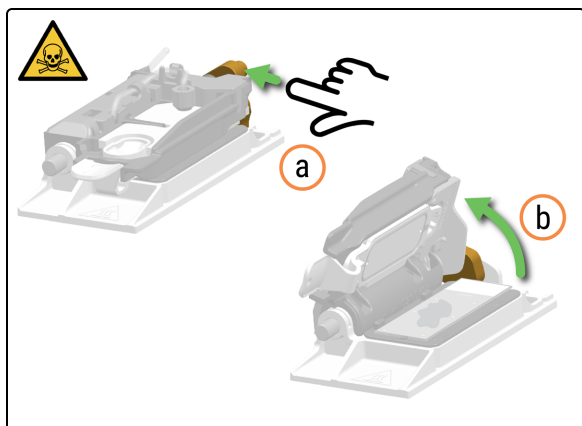

3. Manually open the ARC Module.
  - a. Press the ARC Module Latch.
  - b. Lift the ARC Module Lid.

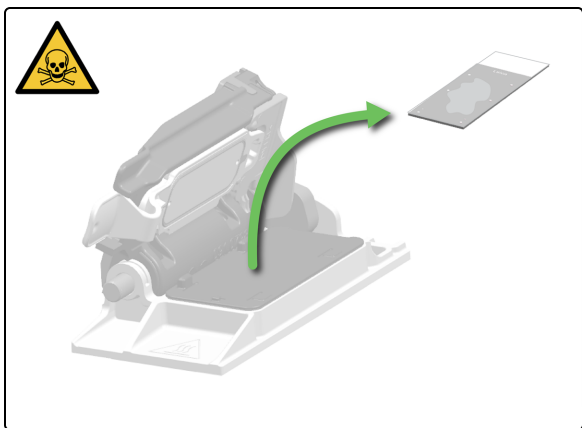

4. Remove the slide from the ARC Module and leave it fully opened. The ARC Modules are automatically closed when you restart the processing module.



You can manually move the Wash Robots to gain better access to the ARC Modules.



**CAUTION:** Be careful not to drop slides when manually handling them over the Work Surface.



**CAUTION:** Do not close the ARC Modules manually. This is done automatically when you start the processing module.

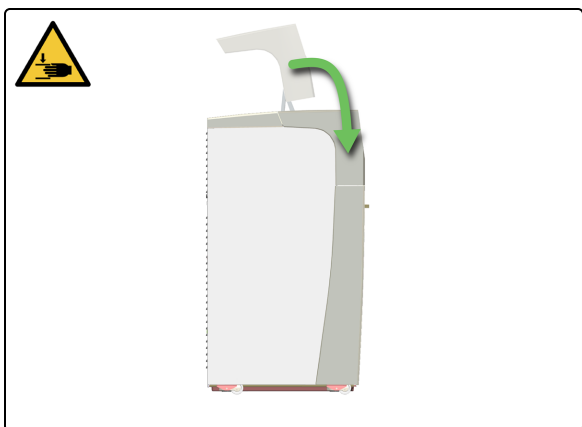

5. Close the Hood.

## 5.4 Remove a slide fragment from an ARC Module

If you notice a slide with a portion missing in the Unload Drawer, you need to find and remove the slide fragment from the ARC Module.



Do not load any new slides.

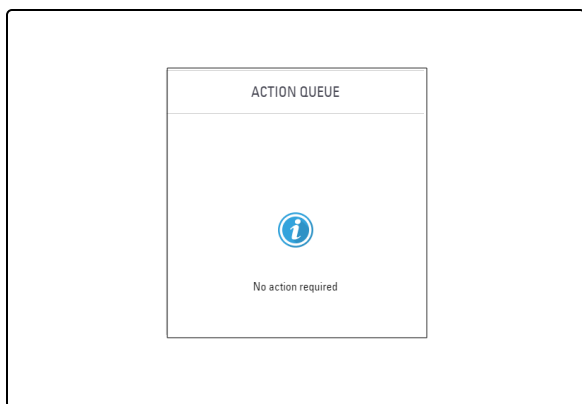

1. Check the Action Queue to see if the error has been flagged by the processing module. If not, then the slide breakage has not been detected.

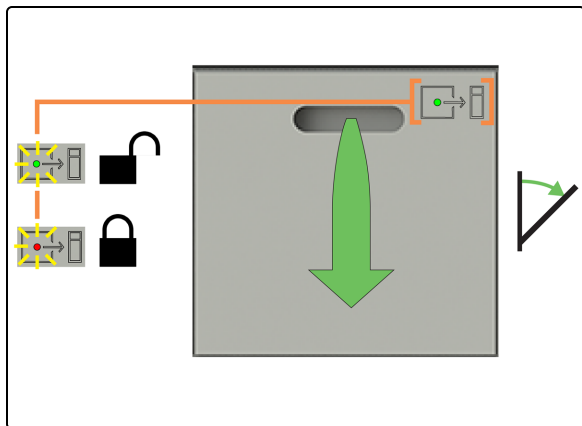

2. Open the Preload Drawer and remove the slides, then wait until all slides have finished processing.



3. Tap **Status**.

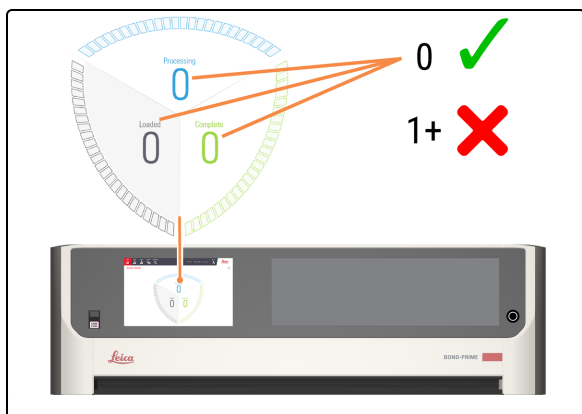

4. Check the Status screen to ensure there are no slides currently being processed (Processing).

Refer to [2.3 Status Screen](#).

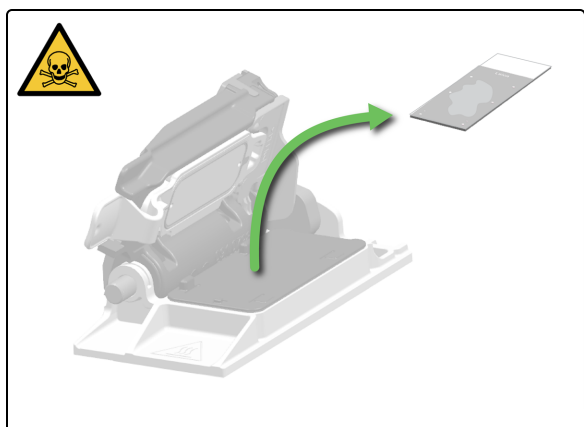

5. Check each ARC Module for glass fragments and manually remove the fragments according to [5.3.3 Manually retrieve slides from ARC Modules](#).

# 6

# Specifications

In this section:

6.1 System specifications .....	198
6.2 Physical specifications .....	198
6.3 Electrical power and UPS requirements .....	198
6.4 Environmental specifications .....	199
6.5 Operating specifications .....	199
6.6 Microscope slide specifications .....	200
6.7 Transport and storage specifications .....	201

## 6.1 System specifications

BOND Application	7 Clinical or later
BOND Controller	Windows 10 IoT, Dell XE2, Dell XE3 or Dell XE4
BOND-ADVANCE Terminal	Windows 10 IoT, Dell XE2 or Dell XE3
BOND-ADVANCE Controller	Windows Server 2016, Dell T640, Dell T630
Network connection	Ethernet IEEE802.3, 10/100/1000BASE-T
Network cables	CAT5e or CAT6 shielded cables, with RJ-45 connectors
Ethernet switch requirements:	Ethernet IEEE802.3, 10/100/1000BASE-T
Single-seat	8-port Ethernet switch (for a maximum of 5 processing modules) *
BOND-ADVANCE	8- or 16-port Ethernet switches (for a maximum of 30 processing modules, when switches are connected together) *
	* any combination of processing modules: BOND-PRIME, BOND-III, BOND-MAX
Device specifications	Leica Biosystems Melbourne Pty Ltd must supply the BOND Controller, BOND-ADVANCE Controllers, and BOND-ADVANCE Terminals.

## 6.2 Physical specifications

Dimensions	W – 1217 mm (47.9 in) H (hood closed) – 1400 mm (55.1 in) H (hood open) – 1820 mm (71.7 in) D (Reservoir Cabinet Door closed) – 831 mm (32.7 in) D (Reservoir Cabinet Door open) – 1096 mm (43.1 in)
Weight (dry)	384 kg (847 lbs)
Weight (loaded with reagent)	425 kg (937 lbs)
Necessary clearances	Front – 800 mm (31.5 in) to access reagent containers Rear – 50 mm (2 in) air gap

## 6.3 Electrical power and UPS requirements

Operating voltage	90 V AC to 264 V AC (for nominal voltage 100 V AC to 240 V AC)
Mains frequency	50/60 Hz
Maximum power consumption	1260 VA

## 6.4 Environmental specifications

The information below is applicable only to installed processing modules.

Maximum peak performance temperature	26 °C (79 °F)
Minimum peak performance temperature	18 °C (64 °F)
Maximum operating temperature	34 °C (93 °F)
Minimum operating temperature	5 °C (41 °F)
Maximum operating humidity (non-condensing)	80 % RH
Minimum operating humidity (non-condensing)	30 % RH
Maximum operating altitude	2700 m (8858 ft) above sea level
Minimum operating altitude	0 m (0 ft) above sea level
Level	0 to 1.5° gradient in any direction
Sound pressure level output (at 1 m)	< 65 dBA normal operation < 85 dBA maximum
Maximum heating energy output	1260 VA at power socket (~1100 W after power supply losses)

## 6.5 Operating specifications

Slides loaded capacity	Maximum 72 slides
Slide concurrent staining capacity	Maximum 24 slides
Reagent container capacity	7 mL and 30 mL
Reagent container dead volume	260 µL (7 mL) and 932 µL (30 mL)
Reagent container reserve volume	280 µL (7 mL) and 280 µL (30 mL)
Titration container capacity	6 mL (maximum fill volume of 5.7 mL)
Titration container dead volume	220 µL
Titration container reserve volume	280 µL
Maximum number of reagent containers	70 (5 Reagent Containers x 14 Reagent Trays)
Ancillary reagents capacity:	
Alcohol	1.25 L
BOND-PRIME Dewax Solution	1.25 L
BOND-PRIME Epitope Retrieval Solution 1	1.25 L
BOND-PRIME Epitope Retrieval Solution 2	1.25 L
BOND-PRIME Wash Solution Concentrate	1.25 L
BOND-PRIME Wash Working Solution	Reservoir 1 L
Bulk DI Water capacity	Container 4.5 L Reservoir 5 L

Bulk waste capacity	Container 4.5 L Reservoir 5 L
Hazardous waste capacity	Container 4.5 L Reservoir 5 L
Chemical compatibility	DI water grade only All BOND-PRIME reagents 100% ethanol, or reagent grade alcohol. Reagent grade alcohol comprises: Ethanol, greater than or equal to 90% (w/w); Isopropanol, no more than 5% (w/w); Methanol, no more than 5% (w/w).  70% ethanol solution is used to clean some parts.
Service life	7 years.
BOND-PRIME Cybersecurity certificate expiry	10 years

## 6.6 Microscope slide specifications

### Slide specifications

Dimensions	Width: 24.64–26.0 mm (0.97–1.02 in) Length: 74.9–76.0 mm (2.95–2.99 in) Thickness: 0.9–1.2 mm (0.03–0.05 in)
Label area	Width: 24.64–26.0 mm (0.97–1.02 in) Length: 16.9–21.0 mm (0.67–0.83 in)
Material	Glass, ISO 8037/1
Usable slide area	Refer to the diagram below.

### Slide label specifications

Dimensions	Width: 22–24 mm (0.87–0.94 in) Length: 15–20 mm (0.59–0.79 in) Maximum 2 stacked labels
Skew angle	User to place the label on straight.
Usable slide label area (within top frosted surface) and permitted slide label placement	No label overhang permitted.



Figure 6-1: Maximum dimensions

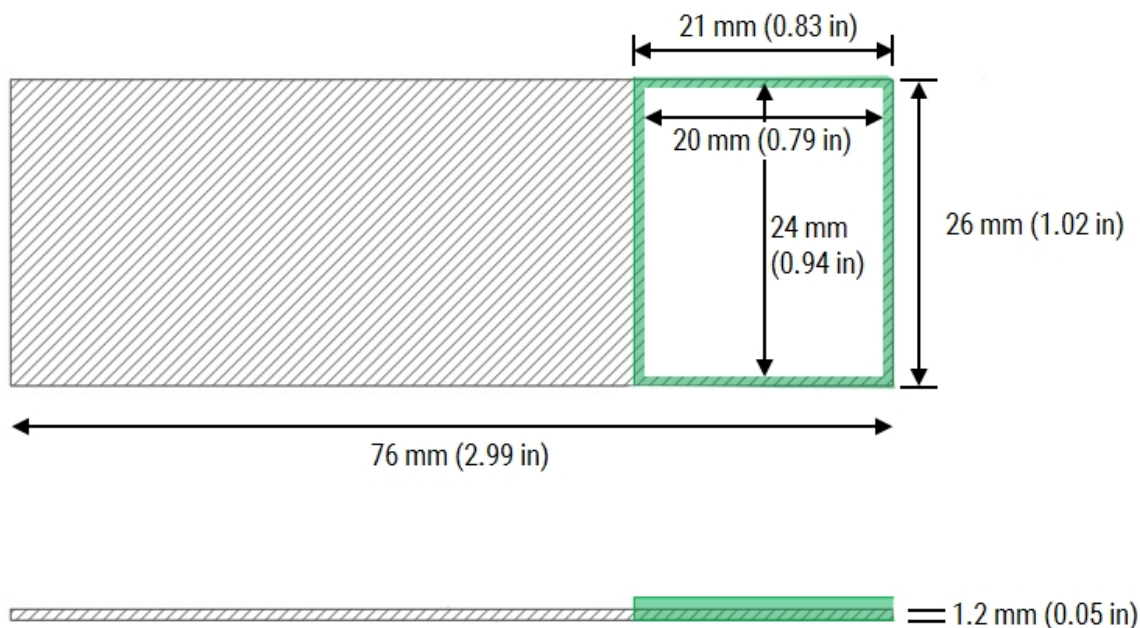

## 6.7 Transport and storage specifications

Crated dimensions	W – 1828 mm (72.0 in) H – 1590 mm (62.6 in) D – 1134 mm (44.6 in)
Crated weight	553 kg (1219 lbs)
Storage temperature	-20 to +50 °C (-4 to +122 °F)
Storage humidity (non-condensing)	< 80% RH
Uncrating requirements	Allow a flat space of approximately 6000 mm x 4000 mm (236.2 in x 157.4 in) to uncrate
Movement on casters	Minimum door width of 850 mm (33.5 in) Traverse a maximum ramp angle of 7 degrees
Shipping methods	Road, air and sea freight compatible

# Index

## A

---

AC power switch.....	38
access the Work Surface	
Maintenance Screen.....	95
shutdown.....	180
start maintenance.....	124
Action Queue.....	66, 68
clear.....	69
Active Reagent Control	
ARC Modules.....	45
add slides.....	102
alcohol	
refill.....	95, 112
Alert Banner	
manually hide.....	69
alerts.....	68
Ancillary Reagents.....	26
AQI.....	66, 68
ARC Bank.....	40
ARC Bank Surface	
clean.....	130
ARC Covertile.....	45
ARC Modules.....	45
clean.....	126
remove slide.....	190
remove slide during power failure.....	193
ARC Probe.....	42
ARC Probe Wash Stations.....	46
clean.....	151

## B

---

bake slides.....	71
banner, alerts.....	68
Barcode scanner.....	30
BOND-PRIME ARC Refresh Kit.....	108, 155
BOND-PRIME Cleaning Kit.....	91, 120
run.....	95
BOND-PRIME Polymer DAB Detection.....	91
BOND-PRIME Processing Module.....	28
BOND System.....	25
Bottles, Bulk Reagent.....	36
Bulk Alcohol Container, refill.....	112
Bulk Container	
refill alcohol.....	112
refill DI Water.....	110
Bulk DI Water Container	
clean.....	160
Bulk Probe Prime Station.....	46
clean.....	151
Bulk Reagent Containers.....	36
close.....	95
Bulk Reagent Probes.....	42
Bulk Waste Container	
clean.....	173
empty.....	118

## C

---

case information, view.....	65
case properties.....	84
cautions.....	22, 68

CE marking .....	11
checklist	
cleaning and maintenance .....	109
chemical hazards .....	20
CISPR 11 (EN 55011).....	12
classification of equipment .....	12
clean	
ARC Bank Surface .....	130
ARC Modules .....	126
Bulk DI Water Container.....	160
Prime Stations .....	151
Reagent Platform .....	130
Slide Drawer Inserts, Waste Drains and Sumps, and Pickup Filter.....	142
Suction Cup .....	134
Sump Tray.....	176
Wash Stations.....	151
Waste Container.....	173
cleaning and maintenance .....	106
Cleaning Kit	
run .....	95
use the BOND-PRIME Cleaning kit .....	120
Cleaning Station, Slide .....	48
clear	
Action Queue .....	69
close Bulk Reagent Containers.....	95
Connect processing module .....	49
Consumables.....	26
contact Leica Biosystems.....	8
Containers	
Bulk Reagent.....	36
Reagent.....	35
copyright .....	6
Covertile	
replace .....	155
Covertile, ARC.....	45

## D

daily maintenance .....	107
decommissioning.....	55
dewaxed slides .....	71
DI Water	
clean container.....	160
refill.....	110
DI Water Container	
clean .....	160
refill.....	110
disconnect processing module .....	51
display	
Action Queue.....	68
disposal, processing module.....	55
Drawers, Unload and Preload.....	31
DS9824 Detection System tray.....	100
Dual Reagent Tray.....	35, 39

## E

eight-monthly maintenance.....	108
electrical connection.....	29
electrical hazards.....	20
electrical specifications.....	198
empty Waste Container.....	118
environmental specifications.....	199
Ethernet.....	29
events, view.....	66

## F

FCC.....	11
fill	
Bulk Alcohol Container.....	112

DI Water Container.....	110
Locked Reagent Containers.....	115
Filter, Slide Drawers.....	32
Front view.....	28
fuses.....	29
replace power supply fuses.....	182

## G

glossary of symbols.....	13
--------------------------	----

## H

handle.....	30
hardware.....	24
Hazardous Waste Container	
clean.....	173
empty.....	118
hazards	
chemical.....	20
electrical.....	20
hazards;installation.....	22
hazards;instrument operation.....	19
hazards;operational.....	22
hazards;reagent.....	23
hide	
Action Queue.....	68
Alert Banner.....	69
High-Speed Robot.....	42
ARC Probe.....	42
Bulk Reagent Probes.....	42
ID Imager.....	42
Probe Selector.....	42
Suction Cup.....	42
Hood.....	30

## I

icons	
Reagent Container.....	91
reagent system.....	91
ID Imager.....	42
identification, product.....	6
IEC 60417.....	15
important information for all users.....	6
initialization failure.....	186
initialize processing module.....	98
Insert	
Slide Drawer Insert.....	32
installation hazards.....	22
instructions for in vitro diagnostic equipment for professional use.....	11
instrument operation hazards.....	19
intended use statement.....	11
ISO 15223-1.....	13
ISO 7000.....	14
ISO 7010.....	18

## L

labels, slides.....	71
legal notices.....	6
load Reagent Tray.....	90, 100
load slides.....	71
Locked Reagent Containers	
refill.....	115
log in.....	57, 98
log out.....	57
Lot Tracked Reagent Containers	
refill.....	115

## M

---

maintenance	
start	124
stop	178
maintenance and cleaning	106
Maintenance schedules	107
Maintenance Screen	95
manufacturer	6
mechanical hazards	21
microscope slide specifications	200
Mixing Block	47
Mixing Station	47
Mixing Well Plate	47
replace	155
move processing module	53

## N

---

Navigation Bar	59
network cable, connect	49
network connection	29

## O

---

operating specifications	199
operational hazards	22

## P

---

Personal Protective Equipment (PPE)	22
physical specifications	198
Pickup Filter	32
Pickup tube, Slide Drawers	32
plug in processing module	49

power button	30
power cable, connect	49
power specifications	198
power supply	29
power supply fuses	
replace	182
power switch	38
Preload Case View, touchscreen	73
Preload Drawer	31
clean	142
retrieve slide	187
Preload Screen	73
preload slides	71, 102
Preparation Station, Slide	48
preventative maintenance	107
Prime Station	
Bulk Probe	46
clean	151
Probe Selector	42
process slides	96, 102
processing module	28
connect	49
decommission	55
disconnect	51
initialize	98
log in	57
log out	57
move	53
shutdown	180
start maintenance	124
stop maintenance	178
product identification	6

## Q

---

quick start	96
-------------	----

## R

---

reagent container details, view.....	92
Reagent Container icons.....	91
Reagent Containers.....	35, 88
reagent hazards.....	23
Reagent Platform.....	35
clean.....	130
reagent system.....	39
reagent system details, view.....	92
reagent system icons.....	91
Reagent Trays.....	39, 88
load.....	90, 100
unload.....	94
reagents.....	26
Reagents Screen.....	88
reagents, mixing.....	47
Rear view.....	29
refill	
alcohol.....	95
Bulk Alcohol Container.....	112
DI Water Container.....	110
Locked Reagent Containers.....	115
regulatory notices.....	11
regulatory symbols.....	13
relocate processing module.....	53
remove	
Reagent Trays.....	94
slides.....	186
slides from ARC Modules.....	190
slides from ARC Modules (power failure).....	193
slides from drawers.....	187
slides from Work Surface.....	188
Waste Container.....	118
replace	
Covertile.....	155
Mixing Well Plate.....	155
power supply fuses.....	182
Suction Cup.....	138
Reservoirs.....	37
retrieve slides.....	186
revision record.....	9
Robot	
High-Speed.....	42
Wash.....	44
run BOND-PRIME Cleaning Kit.....	95

## S

---

safety symbols.....	18
Scanner.....	30
schedule	
BOND-PRIME Cleaning Kit.....	120
scheduling maintenance.....	107
show	
Action Queue.....	68
shut down processing module.....	51
shutdown.....	180
sign in.....	57, 98
sign out.....	57
Single Reagent Tray.....	35, 39
slide baking.....	71
Slide Drawer Inserts.....	32
clean.....	142
Slide Drawer Pickup Filter	
clean.....	142
Slide Drawers	
clean.....	142
Drain.....	32

Filter.....	32	Sump tray	
Pickup tube.....	32	clean.....	176
slide information, view.....	65	Sump Tray.....	28
slide label specifications.....	200	symbols	
slide labels.....	71	safety.....	18
slide positions.....	73	symbols and markings.....	16
Slide Preparation Station.....	48	symbols glossary.....	13
slide processing.....	102	system specifications.....	198
slide properties.....	84		
slide specifications.....	200	<b>T</b>	
slides		touchscreen	
preload.....	102	case view.....	73
remove from ARC Modules.....	190	Maintenance Screen.....	95
remove from ARC Modules (power failure).....	193	Navigation Bar.....	59
retrieve from Drawers.....	187	Preload Screen.....	73
retrieve from processing module.....	186	Reagents Screen.....	88
retrieve from Work Surface.....	188	slide information.....	65
unload.....	78, 102	Slides Loaded Status.....	60
Slides Loaded Segment.....	60	Slides Processing Complete Status.....	64
Slides Processing Complete Segment.....	64	Slides Processing Status.....	62
Slides Processing Segment.....	62	Status Screen.....	60
Spare parts.....	27	unexpected events.....	66
specifications.....	197	Unload Screen.....	80
start		unload slides.....	78
maintenance.....	124	Touchscreen.....	56
processing module.....	98	transport specifications.....	201
Status Screen.....	60	Trays	
stop		load Reagent Trays.....	90
maintenance.....	178	Reagent.....	35, 39
stop maintenance.....	178	Slide Drawers.....	32
storage specifications.....	201	unload Reagents Trays.....	94
Suction Cup.....	42	turn off processing module.....	51, 180
clean.....	134	two-monthly maintenance.....	108
replace.....	138		
		<b>U</b>	
		unexpected events.....	66

Unload Case view, touchscreen .....	80	Bulk Probe .....	46
Unload Drawer .....	31	clean .....	151
clean .....	142	Wash Robot .....	46
retrieve slide .....	187	waste	
Unload Drawer view, touchscreen .....	80	remove .....	118
unload Reagent Trays .....	94	Waste Container .....	118
Unload Screen .....	80	clean .....	173
unload slides .....	78, 102	empty .....	118
unplug processing module .....	51	Waste Drains .....	32
update		Waste Drains and Sumps	
Action Queue .....	69	clean .....	142
UPS requirements .....	198	Waste Sump .....	32
use the BOND-PRIME ARC Refresh Kit .....	155	weekly maintenance .....	107
		well plate, mixing .....	47
<b>V</b>		wipe down	
vials, mixing .....	47	ARC Bank Surface .....	130
view		Reagent Platform .....	130
front .....	28	wipe down ARC Modules .....	126
reagent container details .....	92	Work Surface .....	40
reagent system details .....	92	access .....	95, 124, 178, 180
rear .....	29	retrieve slide .....	188
slide information .....	65		
<b>W</b>			
warnings .....	19, 68		
wash			
ARC Modules .....	126		
Suction Cup .....	134		
Wash/Prime Stations .....	151		
Wash Robot Wash Stations .....	46		
clean .....	151		
Wash Robots .....	44		
Wash Stations			
ARC Probe .....	46		